

RAD7

Electronic Radon Detector

User Manual



Owner: _____

Serial #: _____

SERVICE RECORD

Date: Service:

It is recommended that the RAD7 be returned to DURRIDGE Company annually for recalibration.



WARNING

Opening the cover of this instrument is likely to expose dangerous voltages. Disconnect the instrument from all voltage sources while it is being opened. Due to battery power, the instrument may still be dangerous.

Using this instrument in a manner not specified by the manufacturer may impair the protection provided by the instrument.

TABLE OF CONTENTS

INTRODUCTION	10
Points of special note	10
Shipping and Contact Information	10
1 GETTING STARTED: YOUR FIRST DAY WITH THE RAD7	11
1.1 Unpacking	11
RAD7 Packing List	11
1.2 General Safety Instructions	12
1.2.1 Air Travel	13
1.3 Taking a Look	13
The RAD7 Professional Electronic Radon Detector	13
1.4 Starting a Two-day Test	14
RAD7 Normal Configuration	14
End-of-Run Printout	15
1.5 Starting a Sniff Test	16
RAD7 SNIFF Configuration	16
2 BASICS OF RAD7 OPERATION	18
2.1 Introduction	18
2.1.1 The Keypad	18
2.1.2 Command List	18
2.2 Test	18
2.2.1 Test Status	18
2.2.1a Quick Save-and-Restart	19
2.2.2 Test Start and Test Stop	20
2.2.3 Test Save	20
2.2.4 Test Clear	20
2.2.5 Test Purge	20
2.2.6 Test Lock	21
2.2.7 Test Sleep	21
2.2.8 Test Print	21
2.2.9 Test Com	21
2.3 Data	21
2.3.1 Data Read	22
2.3.2 Data Print	22
2.3.3 Data Com	23
2.3.4 Data Summary	23

2.3.5	Data Free	23
2.3.6	Data Delete	23
2.3.7	Data Renumber	24
2.3.8	Data Erase	24
2.4	Setup	24
2.4.1	Setup Protocol	24
Table 2.4.1	Preset protocols	24
2.4.2	Setup Cycle	25
2.4.3	Setup Recycle	25
2.4.4	Setup Mode	25
2.4.5	Setup Thoron	26
2.4.6	Setup Pump	26
2.4.7	Setup Tone	26
2.4.8	Setup Format	27
2.4.9	Setup Units	27
2.4.10	Setup Savuser	27
2.4.11	Setup Clock	27
2.4.12	Setup Review	28
2.5	Special	28
2.5.1	Special Ident	28
2.5.2	Special SPrOn	28
2.5.3	Special SPrOff	29
2.5.4	Special SetBaud	29
2.5.5	Special Status	29
2.5.6	Special Start	29
2.5.7	Special Stop	29
2.5.8	Special Comspec	29
2.5.9	Special ComAll	29
2.5.10	Special SPrAll	29
2.5.11	Special S-Load	29
2.5.12	Special Version	29
2.5.13	Special Model	29
2.5.14	Special Serial	29
2.5.15	Special Beep	30
2.5.16	Special Relays	30
2.6	Infrared Printer	30
Alpha Energy Spectrum		31
3	BASICS OF RAD7 TECHNOLOGY: HOW IT WORKS	32
3.1	Introduction	32

3.2 Radon and Thoron Decay Chains	32
Radon Decay Chain	33
Thoron Decay Chain	33
3.2.1 Radon-222 (Radon)	34
3.2.2 Radon-220 (Thoron)	34
3.3 Continuous Monitors	34
3.4 Sniffers	35
3.5 Working Level	35
3.6 RAD7 Solid-State Detector	36
3.6.1 RAD7 Calibration and Data Correction	36
3.7 RAD7 Spectrum	37
3.8 Windows	38
3.9 Isotope Equilibrium	39
3.10 Modes: Sniff and Auto	40
3.11 Background	40
3.11.1 Short-lived Radon and Thoron Daughters	41
3.11.2 Adsorbed Radon Gas	41
3.11.3 Intrinsic Background	41
3.11.4 Long-lived Radon Daughters	41
3.11.5 Contamination by Radon, or Thoron, Producing Solids	41
3.11.6 Other Alpha Emitters	42
3.11.7 Beta and Gamma Emitters	42
3.12 Precision & Accuracy	42
3.12.1 Dry operation	42
Table: 3.12 Typical RAD7 precision based on counting statistics only.	43
3.12.2 Humidity Correction	43
3.12.3 Concentration Uncertainties	43
3.13 Spectrum Examples	45
3.13.1 Operational Radon Spectra	45
3.13.2 Thoron Spectra	46
3.13.3 Combination Spectra	47
3.13.4 Pathological Spectra	49
4 USING THE RAD7: MEASURING RADON AND THORON IN AIR	51
4.1 Introduction	51
4.2 Continuous Monitoring	51
4.2.1 Preparation	51
4.2.2 Purging	51
4.2.3 Test Location	52

4.2.4	Test Protocol	52
4.2.5	To Print Or Not To Print	53
4.2.6	Running the Test	53
4.2.7	Security and Quality Control	53
4.2.8	Finishing the Run	54
4.2.9	Examining the Data	54
4.2.10	Very Short Term Monitoring	54
4.3	Sniffing	55
4.3.1	Why Sniff?	55
4.3.2	Locating Radon Entry Points	55
4.3.3	Preparation	55
4.3.4	Purging	55
4.3.5	Running the Test	55
4.3.6	Drilled Sampling Points	56
4.3.7	Spot Readings	56
4.4	Grab Sampling	56
4.4.1	Applicability	56
4.4.2	Preparation	57
4.4.3	Protocol	57
4.4.4	Taking the Sample	57
4.4.5	Analysis	57
4.5	Thoron Measurement	57
4.5.1	Thoron and Radon	57
4.5.2	Thoron Measurement Issues	58
4.5.3	Calculation and Interference Correction	58
4.5.4	Avoiding Longer Lived Decay Products	59
4.5.5	Standard Thoron Setup, Thoron Calibration and Flow Rate	59
4.5.6	Calculating Sample Decay	59
4.5.7	Calculating Internal Cell Concentration	59
4.5.8	Internal Cell Thoron Sensitivity Calibration	59
4.5.9	Setting up a Thoron Measurement	60
4.5.10	Thoron Mode	60
	Recommended RAD7 Thoron Configuration	61
4.5.11	Thoron Measurements in Standard Radon Mode	61
4.6	Managing Background	61
4.7	Airflow Rate Limits	62
4.7.1	Maximum Airflow Rate	62
4.7.2	Minimum Airflow Rate	62
4.8	Harsh and Hazardous Environments	63
4.8.1	Splashing Water	63

4.8.2	Dusty Environment	63
4.8.3	Radiation Hazard	63
5	USING RAD7 ACCESSORIES: TESTING SOIL AND WATER	64
5.1	Introduction	64
5.2	Radon in Water	64
5.2.1	The RAD H2O and Big Bottle Systems	64
5.2.2	The RAD AQUA Accessory	65
5.2.3	The WATER PROBE Accessory	65
5.3	Soil Gas Sampling	65
5.3.1	Application	65
5.3.2	The Soil Gas Probe Accessory	65
5.3.3	Soil Gas Probe Preparation	65
5.3.4	Running the Test	66
5.3.5	Interpreting the Data	66
5.4	Emission Measurements	66
5.4.1	Application	66
5.4.2	Open Loop Configuration	66
5.4.3	Closed Loop Configuration	67
5.4.4	Very Low Emission Rates	67
5.4.5	Bulk Emissions	67
5.4.6	Surface Emission	67
5.5	Supporting Accessories	68
5.5.1	Overview	68
5.5.2	The Range Extender	68
5.5.3	The DRYSTIK	69
6	COMPUTER CONNECTIVITY	70
6.1	Computer Connectivity Basics	70
6.1.1	Connecting the RAD7 to the Computer	70
	Connecting the RAD7 to a Computer with the StarTech Adaptor	71
	Connecting the RAD7 to a Computer with the Keyspan Adaptor	71
6.2	CAPTURE Software	72
6.2.1	Introduction to CAPTURE	72
6.2.2	CAPTURE Installation	72
	CAPTURE Software running on Windows	72
6.2.3	Feature Summary	73
6.2.4	Downloading RAD7 Data	73
6.2.5	Graphing and Analysis	73
6.2.6	Real-Time RAD7 Monitoring	73

6.2.7	CAPTURE CLOUD	73
6.3	RAD7 Communication Protocol	74
6.3.1	Communication Requirements	74
6.3.2	RAD7 Command Format	74
6.3.3	Parsing RAD7 Data	74
	Table 6.3.3 RAD7 Data Record Content	75
6.3.4	Terminal Emulator Tips	76
6.4	Serial Port Specifications	76
6.4.1	Communication Protocol	76
	Table 6.4.1a Serial Port Pin Assignments	76
	Table 6.4.1b Communication Parameters	76
6.4.2	Extending the RS-232 Range	76
7	MAINTENANCE	77
7.1	Accessories - Usage and Care	77
7.1.1	Desiccant	77
7.1.2	Laboratory Drying Unit	77
	Table 7.1.2 Laboratory Drying Unit Life	77
7.1.3	Small Drying Tube	77
	Table 7.1.3 Small Drying Tube Life	77
7.1.4	Cascading Drying Tubes	78
7.1.5	Filters	78
7.1.6	Batteries	78
7.1.7	Real-time Clock and Non-volatile Memory	79
7.1.8	Printer and Adapter	79
7.2	RAD7 Operating ranges	79
	Table 7.2 RAD7 Operating Ranges	79
7.3	Service and Repair	80
7.3.1	Calibration	80
7.3.2	Repair	80
7.3.3	Shipping	80
7.3.4	Upgrades	82
7.4	RAD7 Quality Assurance	82
7.4.1	Spectrum	82
7.4.2	Spill Factor (C Window to B Window)	82
8	TROUBLESHOOTING	83
8.1	LCD Display	83
8.1.1	Blank Display	83
8.1.2	Frozen Display	83

8.1.3 Incomplete Or Garbage Characters	83
8.1.4 NVRAM Error	83
8.2 Readings	83
8.2.1 No Counts	83
8.2.2 Excessive Uncertainty In Reading	84
8.2.3 Run/Cycle Number 0000	84
8.3 Relative Humidity high	84
8.4 Water Catastrophe	84
8.5 Battery Voltage Low	85
8.6 Pathological Values and Error Messages	85
8.7 CAPTURE RAD7 Detection Failure	85
Appendix 1: WIRELESS INFRARED PRINTER	87
A1.1 Infrared Printer Description	87
A1.1.1 General Printer Information	87
A1.1.2 Printer Features	87
A1.1.3 Power Switch	87
A1.1.4 Indicator LEDs	87
A1.1.5 Push Buttons	87
A1.1.6 Sensors	87
Infrared Printer Component Locations and Functions	88
A1.2 Infrared Printer Operation	89
A1.2.1 Precautions	89
A1.2.3 Setup Mode	89
Table A1.2.3 Sel and Feed Functions	89
A1.2.4 Using the Printer	90
A1.3 Infrared Printer Maintenance	90
A1.3.1 Battery Installation	90
A1.3.2 Paper Installation	90
A1.3.3 Cleaning the Printer	91
A1.3.4 Cleaning the Print Head	91
A1.4 Wireless Infrared Printer Specifications	92
Table A1.4 Infrared Printer Specifications	92
Appendix 2: RAD7 Specifications	93
Table A2.1 Functional Specifications	93
Table A2.2 Technical Specifications	93
Table A2.3 Physical Specifications	94

INTRODUCTION

The RAD7 is a highly versatile instrument that can form the basis of a comprehensive radon measurement system. It may be used in many different modes for different purposes. This manual adopts a progressive approach, in which there is, first, a simple, step-by-step description of how to get readings for a) real-time monitoring, and b) sniffing. Next comes a more detailed description of the many features of the instrument and how to access them. The rest of the manual covers a whole range of topics, in somewhat arbitrary order. We recommend that, as soon as possible, you read the entire text, just so that you will have an idea of what there is. While you can start to make good measurements on the first day of ownership of the RAD7, it can take years to master the subtleties of radon and thoron behavior, and to appreciate the full capabilities of the instrument.

We have tried to make the manual easy to use, with a useful table of contents. Please let us know how well we have succeeded. If there are some topics inadequately covered, please tell us. We will issue updates from time to time.

Points of special note

The RAD7 is a rugged and long-lasting piece of equipment. There are many units still in daily use that were sold ten years ago or more. However, it is a sophisticated, precision electronic device, and it is not hermetically sealed, so please treat it with respect. Please do not allow water, other liquids or dirt to get into the machine. If using it somewhere where it may get splashed, damaged, or exposed to rain, please protect it. See Chapter 4.8.1.

The batteries are lead-acid technology, like a car's. If left in a discharged state they will lose capacity. After running the RAD7 on its batteries please recharge them as soon as possible (by plugging in the unit). With careful use the batteries will last five years or more.

Finally, there is one security feature that is sometimes inadvertently set by an inexperienced, though authorized, user; namely the keypad lockout. If the keypad ceases to function, and all you see is **DURRIDGE RAD7** on the display, just do the following: Hold down the [ENTER] and two arrow keys until you hear a beep, release the three keys and immediately push [MENU]. You should then be rewarded by **>Test** on the display. If the tone was set to **OFF**, then you will not hear the beep, so hold the three keys down for three to four seconds, before releasing them and pushing [MENU], - try hold-down times a little longer, or shorter, if, at first, you do not succeed.

Shipping and Contact Information

DURRIDGE U.S. Office	900 Technology Park Drive Billerica, MA 01821 USA Phone: (978)-667-9556 Fax: (978)-667-9557
DURRIDGE UK Office	Sheffield Technology Park Cooper Buildings, Arundel Street Sheffield S1 2NS, UK Phone: +44 (0)114 221 2003
Email	service@durridge.com
Web	www.durridge.com

1 GETTING STARTED: YOUR FIRST DAY WITH THE RAD7



1.1 Unpacking

First make sure you have everything you are supposed to have. Take the materials out of the packing boxes and see if you have all the items shown in the diagram below, or on the packing list enclosed with the shipment. If anything is missing, please email DURRIDGE immediately or call us at (+1) 978-667-9556.

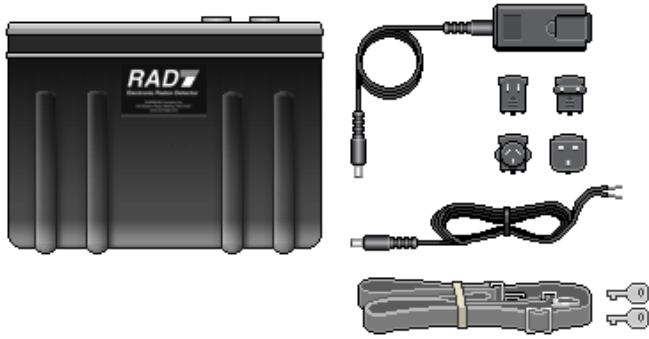
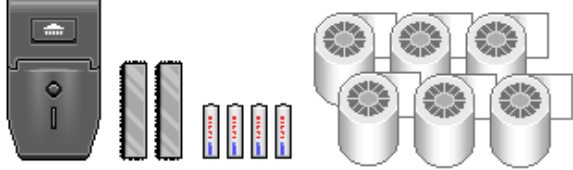
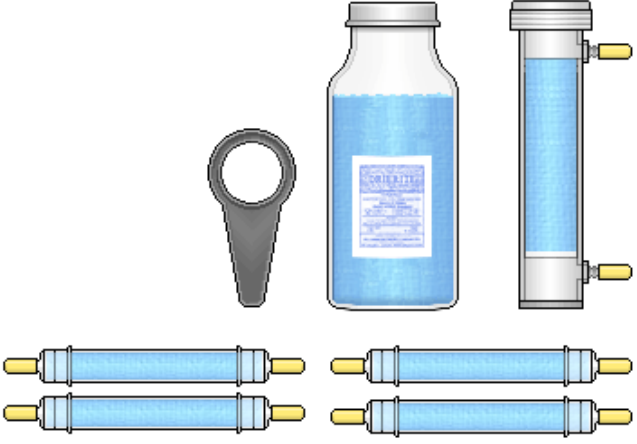
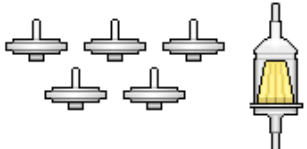
RAD7 Packing List

	<p>RAD7 and Case Accessories</p> <ul style="list-style-type: none"> • RAD7 electronic radon detector • 12V adaptor w/ 4 plugs • 12V cord for custom applications • RAD7 Carrying Strap • Keys for RAD7 case
	<p>RAD7 Printer Supplies</p> <ul style="list-style-type: none"> • Wireless infrared printer • 4 AA alkaline batteries • 6 Rolls printer paper
	<p>Drying Tubes and Desiccant</p> <ul style="list-style-type: none"> • Gas drying unit • Opener tool for drying unit • 5 lbs desiccant • 4 drying tubes
	<p>RAD7 Filters</p> <ul style="list-style-type: none"> • 5 RAD7 inlet filters • 1 Dust filter

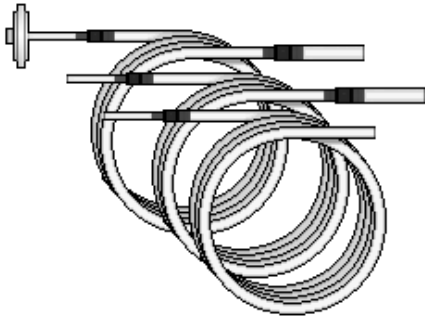
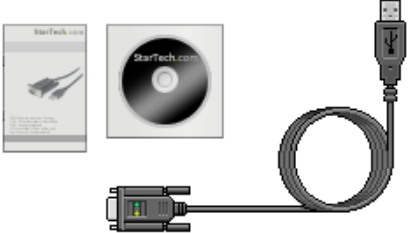
RAD7 Packing List (Continued)

	<p>Vinyl Tubing Set (3ft x 3)</p> <ul style="list-style-type: none"> • From sample to drying tube • From drying tube to RAD7 inlet • From RAD7 outlet to exhaust
	<p>USB/Serial Supplies</p> <ul style="list-style-type: none"> • USB to serial adaptor cable • Adaptor cable documentation • Adaptor cable software driver CD
	<p>RAD7 Documentation Package</p> <ul style="list-style-type: none"> • RAD7 User's Manual • Additional documentation

1.2 General Safety Instructions

For your own safety and the proper operation of RAD7:

DO NOT spill liquids onto the machine.

DO NOT expose operating panel of machine to rain or any other excess moisture.

DO NOT allow liquid to be sucked into inlet tube.

If you intend to use the instrument in a harsh environment, give it some protection. Even just a transparent plastic bag enclosing the RAD7 (but not the air sampling tube) can protect it from splashing mud and water. Allowing the dry air from the RAD7 outlet to exhaust into the interior of the bag will keep the RAD7 in a clean and dry environment.

If liquid does get into the machine, please disconnect the power cord, turn off the power switch, and follow the instructions in Chapter 4.8.1, Harsh and Hazardous Environments: Splashing Water. It will be necessary to return the RAD7 to DURRIDGE for repair.

Do not use your RAD7 if the instrument is damaged or malfunctioning. Please call, or email, the DURRIDGE service department, who will advise what to do about the problem.

Replace a frayed or damaged power cord immediately. Electrical equipment may be hazardous if misused. Keep away from children.

Do not open or attempt to repair the machine. The detector has an internal high voltage supply that can generate more than 2,500V.

The batteries are Gates Monobloc type 0819-0012, 6V 2.5Ah. There are two installed in the instrument. They are not user replaceable.

1.2.1 Air Travel

It is safe to take the RAD7 on an airplane either as carry-on or checked baggage. It is probably easiest, and least likely to cause problems, if it is put inside a suitcase, with clothes, and checked in. However when putting the RAD7 in checked luggage, it is very important to leave the

instrument's air outlet open to the outside air, in order to prevent a pressure difference from occurring between the inside and outside of the instrument.

Some airlines and some airline staff are concerned about lead-technology batteries, such as those in the RAD7. An MSDS sheet, issued by the battery manufacturer, is enclosed with the manual in the RAD7 documentation. A copy of that should be carried and presented when requested, when traveling with a RAD7 by air.

1.3 Taking a Look

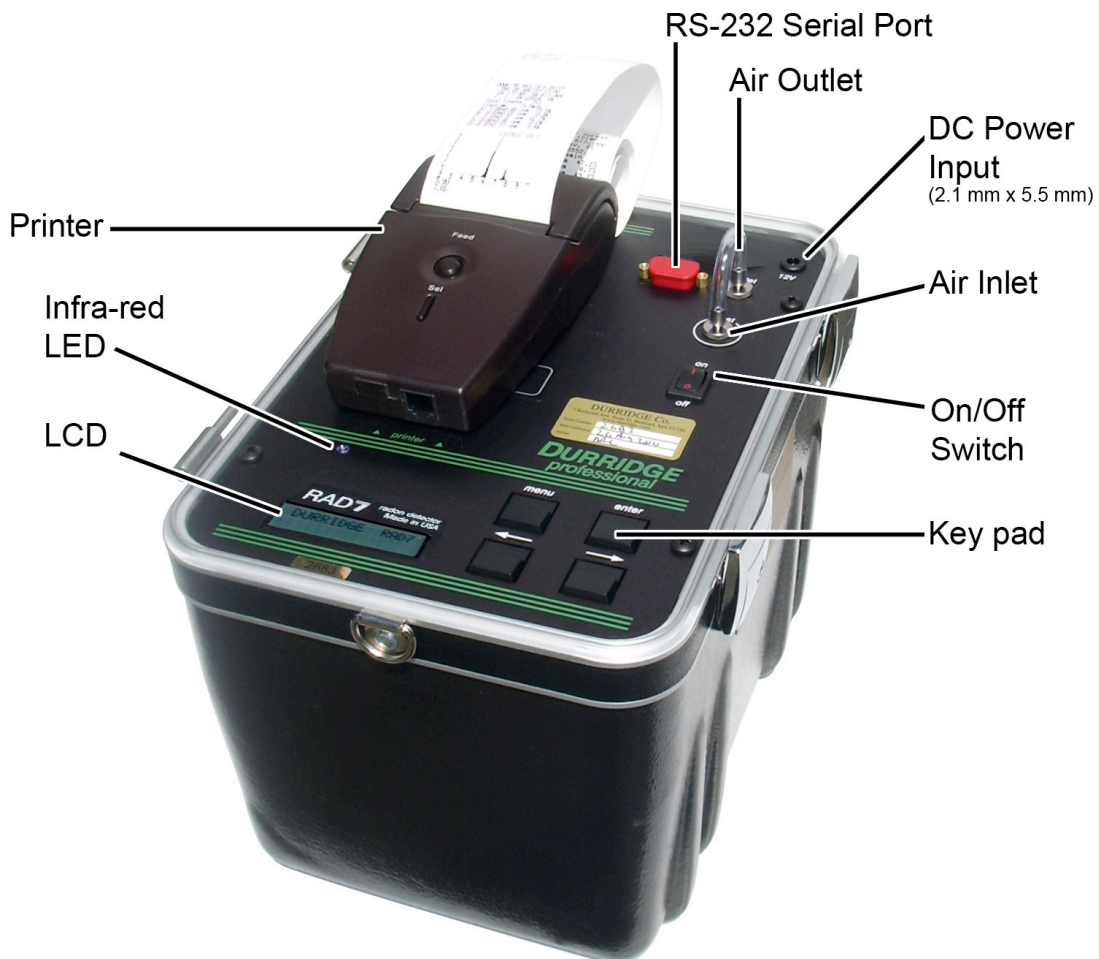

The RAD7 Professional Electronic Radon Detector

1.4 Starting a Two-day Test

You will need the RAD7 and power cord, the Laboratory Drying Unit (the large tube of desiccant, with a screw cap at one end), an inlet filter (one of the six small filters supplied), the piece of tubing with a 5/16" ID segment at one end and a 1/8" ID segment at the other and the printer.

On first starting up, you may need to set the clock for your time zone (See Setup Clock, Chapter 2.4.11). Switch on the RAD7, push [MENU], then push [→] twice. You will see Setup on the display. Push [ENTER], then push [→] ten times. You will see Setup Clock. Push [ENTER]. Use the arrow keys to adjust hours, minutes, seconds, day, month and year, pushing [ENTER] to confirm each setting. Now we are ready to continue.

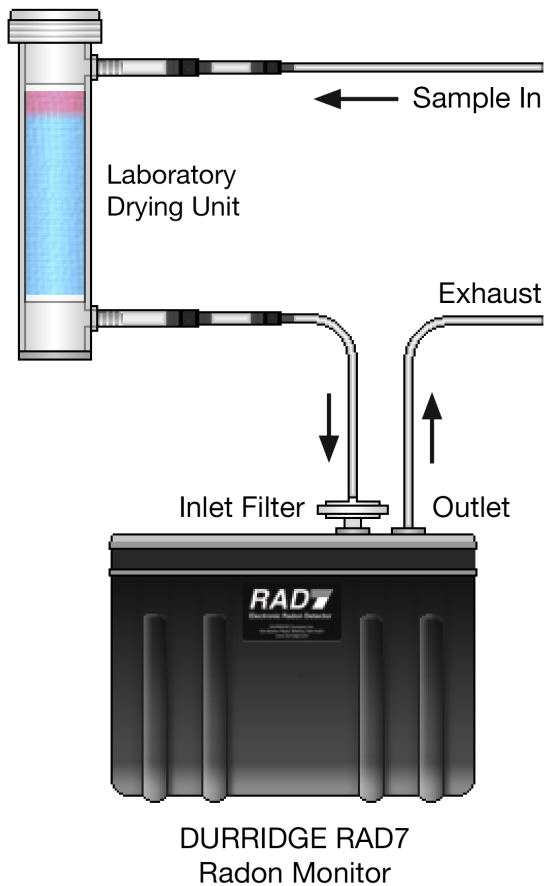

RAD7 Normal Configuration

Attach the filter to the tubing (push it into the end with the insert).

Carefully remove both plastic caps from the Drying Unit (you will need them later, to reseal the unit). Attach the sleeved end of the tubing to the tube fitting, on the Drying Unit, farthest from the screw cap.

Attach the filter to the Inlet port of the RAD7. The air sampling system is now set up for the measurement. (See RAD7 Standard Configuration diagram at left.)

Plug in the RAD7 and switch on.

Push [MENU], [ENTER], then push [→] four times. You should see on the LCD display: Test Purge.

Push [ENTER]. The pump should start.

Set up the printer (insert paper and batteries - see manual).

Place printer between green lines on face plate (See photo, Chapter 1.3).

After purging for some time (normally, at least five minutes), push [MENU], and [→] two times, you will see: Setup on the display.

Push [ENTER] twice, then push either arrow key repeatedly until you see: Protocol: 2-Day on the display. Push [ENTER].

With Setup on the display, push [ENTER], then [→] seven times, to see >Setup Format on the display. Push [ENTER] then use arrow keys to select Format: Short. Push [ENTER].

Switch off the RAD7. Switch on the printer, now switch the RAD7 back on. The printer will print out something like the following:

```
DURRIDGE RAD7
Vers 3.1a 151208
Model 716
Serial 00512
Calib 21-MAY-17
```

```
Last used
FRI 21-MAY-17 17:30
```

```
Current settings
FRI 21-MAY-17 19:09
```

Protocol: 2-Day
 Cycle: 01:00
 Recycle: 48
 Mode: Auto
 Thoron: Off
 Pump: Auto
 Tone: Geiger
 Format: Short
 Units: pCi/L °C

m) Push [MENU], [ENTER], [→]. You should see on the LCD display: >Test Start

n) Push [ENTER]. The pump will start running. On the LCD display you will see something like:

```
0101      Live      Sniff
00:59:37      00001
```

You are now monitoring the radon level right where you are. Every hour, the printer will print out a reading something like this:

```
0102  2.69 " 0.73 p Sniff
      FRI 21-MAY-13 19:41
      26.8 C  RH: 7%  B:7.06V
```

Where 0102 are the run (01) and cycle (02) numbers, 2.69 is the measured radon concentration, 0.73 is the two-sigma STATISTICAL uncertainty, p indicates the units (in this case pCi/L), and Sniff shows that, for this reading, only the Po-218 decays are being counted (after three hours, the mode changes automatically to Normal). The second line is clearly the date and time, while the third shows the temperature and humidity inside the measurement chamber, and the battery voltage. Medium and Long format settings print more information each cycle.

If you allow the RAD7 to complete a run, it will print out a summary of the entire run, including:

1. Date and time
2. Machine serial number
3. Average value for the test
4. Bar chart of the individual readings, and
5. Cumulative alpha energy spectrum.

In the example shown it may be seen that the average level was 3.71 pCi/L, or 137 Bq/m³.

To terminate the run early, you may switch off the RAD7. The data collected, to the end of the last completed cycle, is automatically stored in the RAD7 memory, and available for later display, printing or download to a PC. If you wish to store the last, incomplete cycle data as well, use Test Save before switching off the RAD7. When you do this, the end-of-run printout does not take place. The summary is stored in memory and may be printed at any time, except that the cumulative spectrum, which would have been printed out at the end of the run, is lost.

End-of-Run Printout

```

Run 02
Begin 09-JAN-08 15:33
Serial 02094
Cycles = 048
Mean: 3.71 pCi/l
S.D.: 0.46 pCi/l
High: 5.13 pCi/l
Low: 2.55 pCi/l

          0 pCi/l          10.0
15:33 ██████████
16:33 ██████████
17:33 ██████████
18:33 ██████████
19:33 ██████████
20:33 ██████████
21:33 ██████████
22:33 ██████████
23:33 ██████████
00:33 ██████████
01:33 ██████████
02:33 ██████████
03:33 ██████████
04:33 ██████████
05:33 ██████████
06:33 ██████████
07:33 ██████████
08:33 ██████████
09:33 ██████████
10:33 ██████████
11:33 ██████████
12:33 ██████████
13:33 ██████████
14:33 ██████████
15:33 ██████████
16:33 ██████████
17:33 ██████████
18:33 ██████████
19:33 ██████████
20:33 ██████████
21:33 ██████████
22:33 ██████████
23:33 ██████████
00:34 ██████████
01:34 ██████████
02:34 ██████████
03:34 ██████████
04:34 ██████████
05:34 ██████████
06:34 ██████████
07:34 ██████████
08:34 ██████████
09:34 ██████████
10:34 ██████████
11:34 ██████████
12:34 ██████████
13:34 ██████████
14:34 ██████████

```

Cumulative Run Spectrum

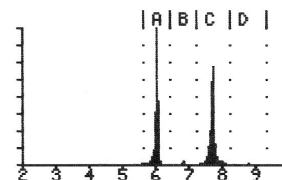

1.5 Starting a Sniff Test

Sniffing lets you make quick, qualitative surveys of radon and thoron levels. It may be used to search for radon entry points. There are some advantages in sniffing for both thoron and radon at the same time, (see Chapter 3.13.3), so that is the procedure described here.

You will need the same equipment as for the 2-day test, above, except that a small drying tube should be used, instead of the laboratory drying unit. Also, for portability, you may remove the external power from the RAD7, and run the RAD7 on its batteries.

If you have not already done so, set the clock, as described above.

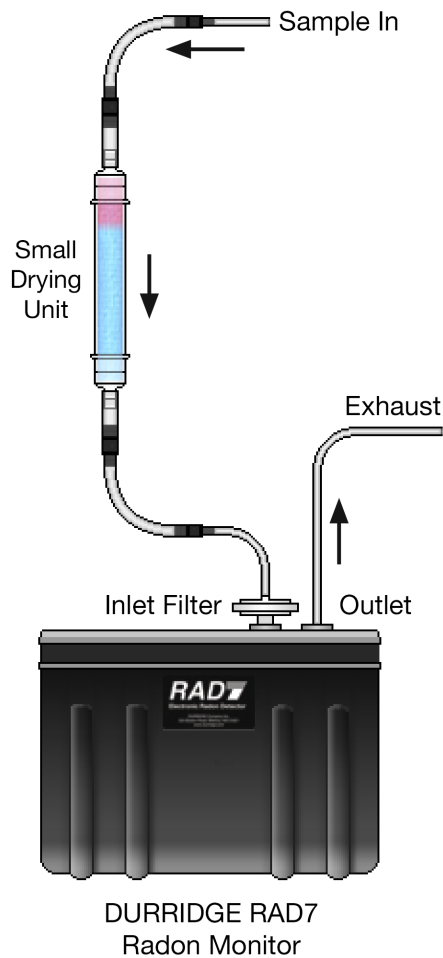

RAD7 SNIFF Configuration

- a) Attach the filter to the tubing (push it into the end with the $\frac{1}{8}$ " ID segment)
- b) Carefully remove both plastic caps from the small drying tube (you will need them later, to reseal the unit). Attach the $\frac{5}{16}$ " ID end of the tubing to one end of the tube.
- c) Attach the filter to the Inlet port of the RAD7. Make sure it is firmly fit onto the inlet. The air sampling system is now set up for the measurement. While testing, you can use the small drying tube as a wand, to collect your air sample from the location of interest.
- d) Plug in the RAD7 and switch on.
- e) Push [MENU], [ENTER], then push [→] four times. You should see on the LCD display: Test Purge.
- f) Push [ENTER]. The pump should start.
- g) Set up the printer.
- h) Place printer between green lines on the face plate (See photo, Chapter 1.3).
- i) After purging for a few minutes push [MENU], and [→] two times, you will see: >Setup on the display.
- j) Push [ENTER] twice, then push either arrow key repeatedly until you see: Protocol: Thoron on the display. Push [ENTER]. (See Chapter 2.4.5 for difference between Thoron and Sniff protocols).
- k) With Setup on the display, push [ENTER], then [→] seven times, to see Setup Format on the display. Push [ENTER] then use arrow keys to select Format: Short. Push [ENTER].
- l) Switch off the RAD7. Switch on the printer, now switch the RAD7 back on. The printer will print out something like the following:

DURRIDGE RAD7
Vers 3.1a 151208
Model 716
Serial 00512
Calib 21-MAY-17

Last used
WED 23-MAY-17 17:30

Current settings
FRI 25-MAY-17 19:09

Protocol: Thoron
Cycle: 00:05
Recycle: 00
Mode: Sniff
Thoron: On
Pump: Auto
Tone: Geiger
Format: Short
Units: pCi/L °C

m) Push [MENU], [ENTER], [→]. You should see on the LCD display: >Test Start

n) Push [ENTER]. The pump will start running. On the LCD display you will see something like:

```
0201      Live      Sniff
00:04:37                00001
```

You are now sniffing for thoron and radon. Every five minutes, the printer will print out a reading something like this:

```
0203  2.69 ± 2.83 p  Sniff
      1.68 ± 2.15 p  Thoron
      FRI 21-MAY-17  19:41
      26.8 °C   RH: 7%   B:7.06V
```

Where 0203 are the run (02) and cycle (03) numbers, 2.69 is the measured radon concentration, 2.83 is the two-sigma STATISTICAL uncertainty, p indicates the units (in this case pCi/L), and Sniff shows that, for this reading, only the Po-218 decays are being counted. The second line is the measured thoron concentration and uncertainty. The third line is now the date and time, while the fourth shows the temperature and humidity inside the measurement chamber, and the battery voltage. Medium and Long format settings print more information each cycle.

Note that the Po-218 has a 3-minute half life. After moving to a new location, it will take about 15 minutes for the count rate to reach equilibrium with the new radon concentration. So not until after the third 5-minute cycle will the reading indicate the new level. However, the thoron daughter, Po-216, has a very short half life (150 ms), so the response of the RAD7 to thoron is virtually instantaneous. For thoron, the first 5-minute cycle is as good as any other.

Thoron will only be found very close to radon entry points. That, together with its fast response, makes thoron sniffing an excellent sleuth for radon entry points.

To terminate the run any time, you may switch off the RAD7. The data collected, of completed cycles, is stored in the RAD7 memory, and available for later display, printing or downloading to a computer.

2 BASICS OF RAD7 OPERATION

2.1 Introduction

2.1.1 The Keypad

The RAD7 is operated through a four-key menu-driven interface. These four keys allow you to look at the commands, select one, and then do it.

Menu Key

Press [MENU] and you see the menu prompt (>) and the word Test:

```
>Test
```

Arrow Keys

Press the forward and backward arrow keys to go through the available options. To advance quickly through the options, hold down the key so that it "auto-repeats."

The arrow keys allow you to move right and left through the various commands, looking for the action you want.

Enter Key

When you have decided on a certain menu option, you select it by pressing [ENTER]. The enter key tells the RAD7 that you have made your selection. You are telling it what you want it to do.

The enter key makes it happen.

2.1.2 Command List

The RAD7 command list has four command groups: Test, Data, Setup and Special. The Test group of commands controls the collection of new radon data. The Data group retrieves data from memory, outputs them, and gets rid of old, unwanted data. The Setup group prepares the RAD7 to operate according to your requirements. The Special group is a set of commands that are available when RADLINK, the remote control software, is loaded.

2.2 Test

The Test group of commands controls the collection of radon data and allows you to manipulate the current test (test-in-progress). You can start and stop data collection, save or clear the current test, or print the current test as it stands. (The Test commands do not allow access to stored data. You have to go to Data for that.)

2.2.1 Test Status

To see the status display, enter the Test Status command. Press [MENU], [ENTER], [ENTER]

On the LCD display, you will see:

```
0501      Idle      Sniff
00:30:00      00000
```

On the upper left, you see the current run number/cycle number (0501 - run 05, cycle 01.).

The middle shows the detector status (Idle or Live), and the upper right gives the current test mode (Sniff, Normal or Grab). (Note that in AUTO mode, the indication will change from Sniff to Normal after three hours of measurement.

Lower left shows the count-down timer (00:30:00 = 30 minutes) which counts down to zero when the detector is Live (i.e., a test is in progress). The lower right shows the total number of counts since the beginning of the current cycle.

The arrow keys may now be used to access additional status information.

Press [→] once, and you will see something like this:

Last reading:

```
0409  1.80 " 0.74 p
```

The lower left is the run number (2 digits) and cycle number (2 digits) of the last completed cycle stored to memory.

The lower right is the radon reading and two-sigma statistical uncertainty, followed by "p",

indicating picoCuries/liter, or "b" for Becquerels/ cubic meter.

When a cycle ends, the information on this display is updated. If there have been no readings yet, the display will show

No readings yet.

Press [→] once again, and now you will see something like this:

```
24.8°C      RH: 3%
B: 6.36V    P: 00mA
```

Top left is the internal temperature. (To change from Celsius to Fahrenheit, see Chapter 2.4.9, Setup Units.)

Top right shows the internal Relative Humidity reading. When testing, maintain this value at 10% or less, by using the desiccant.

Bottom left is the battery voltage. This should range from about 6.00V to 7.10V. A discharged battery (less than 6.00) should be recharged as soon as possible. A fully charged battery will rest at 6.40 to 6.50 V. During a recharge, the voltage will eventually rise above 7.00 V. At no time should this read higher than 7.20V. In the lower right is the pump current. This number should vary from 00mA (pump off) to 80mA. When the pump is running with a light load, the current will range from 40-70mA. When the pump is running with a heavy load (clogged filter or blocked hose), the current will go to 90mA or higher. Pump currents above 90mA are considered a sign of trouble. Try changing the filters and check for blockage.

Press [→] again, and you will see something like this:

```
HV: 2218V, 10%
L: 02      S: 0.21V
```

This is a display of diagnostic values. Ordinarily it will be of little interest to you.

The top line is the high voltage reading and High Voltage Duty Cycle. The range of normal values is from 2000 to 2500V, and from 8% to 18%, respectively.

The lower left corner is the leakage current. At room temperature, this value will normally range from 0 to 10. Higher temperatures ordinarily cause this value to rise. Excessive leakage current will result in "noise" in the lower energy end of the spectrum, and will also cause broadening of the alpha peaks.

The lower right corner is the signal voltage from the analog circuit. This number should be "stable"; that is, fluctuations should be no more than " 0.05V from the average value.

Press [→] yet again, and you will see something like this:

```
w | cpm | +/- | %tot
A | 6.0 | 4.3 | 48.8
```

This is the display for the A window data. You may press [→] to advance to B, C, D, etc.

The RAD7 records 8 windows (A - H) every time you make a measurement. They separate counts due to daughters of radon and thoron, and the background. Specific alpha particles end up in specific windows.

W: The window letter.

cpm: The counts per minute observed in the window.

+/-: The two-sigma statistical uncertainty of the cpm value, also in units of cpm.

%tot: The number of counts in the window as a percentage of the total counts in the spectrum. This tells you quickly where the majority of the counts are: In the 3-minute radon peak (window A), or the long-lived radon peak (window C), etc.

As always, you press the [MENU] key to exit this display and return to the start of the menu.

2.2.1a Quick Save-and-Restart

This function allows the user to end a sniff test, store it to memory, and start up a new sniff test, all using a single key. It operates only from the SNIFF mode.

From the status display (showing the countdown timer), press the [ENTER] key once. The display will show:

Save and restart
? Yes

Press the [ENTER] key once more to confirm your intention. To escape, push the [MENU] key or push an arrow key to select "No" and push [ENTER].

2.2.2 Test Start and Test Stop

To start testing (or "counting"), after you have chosen the required setup, go to >Test Start by pressing [MENU], [ENTER], [→], and then [ENTER]. The display will indicate that counting has begun:

Start counting.

One second later, the Status display will appear with the countdown timer in motion:

```
0501      Live      Sniff  
00:29:37      00001
```

When the countdown reaches zero, the RAD7 will automatically calculate the radon concentration, store (or "save") the counts to memory, and clear the counters to begin a new cycle.

To interrupt the measurement, go to >Test Stop

by pressing [MENU], [ENTER], [→], [ENTER].

The display will respond:

Stop counting.

After one second, the display will go back to the top of the menu >Test.

You may wish to examine the Status display to verify that the status is Idle.

To resume testing from exactly the same point in the cycle where you stopped, select >Test Start as described above.

Note that Stop does not terminate the run, it is a pause. If you do not wish to resume testing from the same point, you should select either >Test

Save or >Test Clear before continuing. This will terminate the suspended test, store it to memory (Save) or wipe it out (Clear), and clear the counters to begin a new run.

2.2.3 Test Save

The >Test Save command suspends counting and saves the suspended test (test-in-progress) to memory as if it had reached completion. Test Save completes the current run, so any subsequent test data will be stored as a new run. The display momentarily shows the run and cycle number in the form of 0101 Saved. This command may be accessed whether the status is Live or Idle. It always leaves the status Idle.

You will find this command especially useful when you wish to move the instrument to another location without waiting for the countdown to reach zero, but without losing that last incomplete cycle. The calculated radon concentration from the incomplete cycle is still good.

2.2.4 Test Clear

The >Test Clear command causes counting to be suspended and the current run to be completed without saving the last (suspended) incomplete cycle. Subsequent test data will be stored as a new run. You must answer Yes to the question Are you sure? in order to activate this command.

This command may be accessed whether the status is Live or Idle. It always leaves the status Idle.

2.2.5 Test Purge

The >Test Purge command suspends counting and begins purging the detector. The pump begins running and the high voltage circuit turns off in order to clear the sample chamber of radon gas and daughters as quickly as possible. You must provide clean, desiccated, radon-free air to the inlet in order to push out any radon that was previously sampled. Outdoor air is usually adequate for this purpose.

As always, use the inlet filter and drying tube. Ten minutes is usually sufficient for bringing the

background down after exposure to moderate amounts of radon.

In order to dry out the RAD7 without using up much desiccant, connect the hoses from the RAD7 to the drying unit, as a loop. When the pump runs, the same air will circulate repeatedly through the desiccant. This procedure will efficiently remove residual moisture from the RAD7. This does not introduce any fresh air, and so does not change the radon level in the instrument, but you can make a measurement of the background while it is set up in this configuration.

To end the purge, answer Yes to the question Stop purge? which appears on the display. Alternatively, you may push [MENU] to end the purge.

2.2.6 Test Lock

The >Test Lock command activates a RAD7 security feature to prevent people from tampering with the instrument while it is in use. While the RAD7 is locked, active measurements will continue uninterrupted, but the buttons on the keypad become unresponsive.

If you select >Test Lock and push [ENTER], the keypad will lock and the LCD display will just show:

```
DURRIDGE RAD7
```

Nobody will be able to unlock the keypad, unless they know the secret.

Switching the unit off, while locked, will stop the measurement, but the keypad will still be locked when the RAD7 is switched on again.

To unlock the keypad, hold the [ENTER] and both arrow keys down, all together, for 3 - 4 seconds, or until the unit beeps, then release the three keys and push [MENU] immediately.

The Test Lock feature should be used whenever there is a risk that an unauthorized individual might tamper with the RAD7.

2.2.7 Test Sleep

The >Test Sleep command allows you to turn off most of the electronic circuits, with the power switch on, in order to conserve battery charge. A fully charged RAD7 should be able to "sleep" for about one week on batteries alone. Press the menu key to "wake up" the RAD7.

The Sleep function was particularly useful for older RAD7 models that did not have the Real Time Clock (RTC) and Non-Volatile Memory (NVRAM) options. New and upgraded instruments may be shut down completely, power switch off, without losing any stored data or clock.

2.2.8 Test Print

The >Test Print command calculates results for an incomplete or suspended test cycle and prints them according to the print format that is currently set.

Spectrum output is available by selecting >Setup Format Long beforehand.

If you wish to abort printing, press the [MENU] key. The run number and cycle number that ordinarily appear on printed data are replaced by 0000 to signify that the cycle is not completed.

2.2.9 Test Com

The >Test Com command outputs the results for an incomplete test cycle to the serial port.

If you wish to abort output, press the menu key. The run number and cycle number that ordinarily appear with the data are replaced by 0000 to signify that the cycle is not completed.

2.3 Data

The Data group of commands retrieves data from memory, displays it, prints it, reports it graphically, and outputs it to the serial port. The Data group also includes commands for managing memory. The memory will hold the data for 1,000 cycles, in up to 100 runs.

Many commands in the Data group require you to enter a two-digit run number after the command. The "default" run number (the one automatically

set if you do nothing) is the run number of the last complete cycle of data stored. The arrow keys allow you to select any other run number.

2.3.1 Data Read

Select **>Data Read** followed by a two-digit run number, to examine radon readings from that particular run. For example, select **>Data Read 01** to examine readings from run number 01, the first test in memory.

You will see something like this:

```
0101  23.3 ± 1.54 p
    11:45      19-MAY-17
```

Line 1 is the run/cycle number followed by the radon concentration, two-sigma uncertainty, and unit indicator. This example shows:

Run 01, Cycle 01, 23.3 ± 1.54 pCi/L.

Line 2 is the time (24-hour military time) and date the reading was completed.

Press **[→]** to advance to the next reading in memory; press the backward arrow to go back to the previous reading.

To quit examining data, press **[ENTER]** or **[MENU]**.

Note that large numbers are presented in shorthand notation. The symbol “K” stands for 1,000 and “M” stands for 1,000,000. For example, 33K2 stands for 33,200.

2.3.2 Data Print

To print out a run of data from memory, select **>Data Print** followed by the two-digit run number. For example, to print the data from run number 05, select **>Data Print 05**.

If the printer format has been set to Short, the following printout will be made for each cycle of the run:

```
0501  2.69 ± 2.83 p Sniff
    FRI  21-MAY-17 19:41
    26.8 °C RH: 7% B:7.06V
```

Line 1 is the run/cycle number, the radon concentration, the two-sigma uncertainty, the units indicator (p=picoCuries per liter, B=Becquerels per cubic meter), and the mode indicator.

Line 2 is the date and time that the cycle was completed and stored to memory.

Line 3 is the temperature (in either "C" Celsius or "F" Fahrenheit), relative humidity (internal), and battery voltage at the time the cycle ended.

If the printer format has been set to Medium or Long, then you will see a printout like this for each cycle:

```
0501  2.69±2.83 p Sniff
    FRI  21-MAY-17 19:41
    26.8°C RH: 7% B:7.06V
    L: 1   HV:2218V, 9%
Total Counts:  42.
Livetime:  27.8min
A: 0.53±0.08 cpm   47.3%
B: 0.02±0.02 cpm   1.7%
C: 0.52±0.08 cpm  46.4%
D: 0.01±0.02 cpm   0.9%
O: 0.04±0.03 cpm   3.6%
```

Lines 1, 2, and 3 are the same as in Short format, as outlined above.

Line 4 indicates the Leakage Current, the High Voltage, and the High Voltage Duty Cycle.

Line 5 contains the total number of counts detected during the cycle.

Line 6 is the Live Time, the time that the detector was actively collecting data.

Lines 7 through 11 are the windows data for windows A, B, C, D, and O. (O is the consolidated window for "others", or counts that are in windows E, F, G, and H.)

Each line of windows data contains the window letter (A, B, C, etc.) followed by the window's counts per minute (cpm), two-sigma statistical uncertainty of the counts per minute, and percent of the total counts included within that window.

NOTE: The RAD7 does not store spectra from previous runs, so no spectra will print from memory even if the printer format is Long. If you

need a spectrum, be sure you print it before advancing to the next test.

If no data are available to print, the RAD7 will beep and display **No tests stored**.

To abort a printout, press the menu key, then press the printer paper advance button.

2.3.3 Data Com

The RAD7 has an RS232 port that can transfer data to your computer. Status must be Idle.

To send a run of data to the serial port, select **>Data Com** followed by the two-digit run number. When ready, push [ENTER]. The following message will appear on the display as the data is sent:

```
Data transfer ...
```

When the data transfer finishes, the RAD7 will beep.

To enable your PC to receive data, appropriate software should be running. A terminal emulation program or DURRIDGE's CAPTURE software may be used. See Chapter 6 for more details on data communication. Table 6.3.3 contains information on parsing the content of the Data Com response.

2.3.4 Data Summary

To print a summary report and time graph of a run's data, select **>Data Summary** followed by the two-digit run number. The following information will be printed:

```
Run 31
Begin 01-Jun-17 12:49
Serial 00500
Cycles = 048
Mean: 0.77 pCi/l
S.D.: 0.27 pCi/l
High: 1.41 pCi/l
Low: 0.20 pCi/l
```

where:

Line 1 is the run number.

Line 2 shows the date and time of the first reading.

Line 3 is the serial number of the instrument.

Line 4 is the number of completed cycles in the run.

Line 5 is the arithmetic mean (or "average") of the radon concentrations recorded.

Line 6 is the standard deviation of the readings taken during the run.

Lines 7 and 8 are the highest and lowest radon concentrations.

Following Line 8 is a bar graph of radon concentration through time. Time-of-day is printed along the left-hand edge of the graph. If there is only one cycle of data, the bar graph will not print.

This printout procedure has been programmed into several protocols. When you choose one of the pre-programmed protocols, this report is printed out automatically at the end of the run, together with a cumulative spectrum.

2.3.5 Data Free

To determine the amount of free memory available for storing new radon readings, select **>Data Free**, and push [ENTER].

For about two seconds, the display will look something like this:

```
910 cycles free.
```

The RAD7 can store up to 999 cycles of data. As the memory fills with data, the Data Free indicator decreases. If the Data Free indicator reaches 000, any subsequent attempt to store data to memory will result in a "memory full" error.

Keep your eye on this indicator to avoid embarrassment! When the amount of free memory gets uncomfortably low (i.e. 200 or less), consider deleting un-needed old data to open up space for new data. See Data Delete and Data Erase.

2.3.6 Data Delete

To delete an entire run of data, select **>Data Delete** followed by the two-digit run number. The display will prompt you for confirmation:

Delete run 31?

No

Press [→] to find Yes, then press [ENTER] to delete the run's data from memory and free the space for new data. No other run's data will be affected.

After deletion of a run's data, any attempt to retrieve the data will result in a **No tests stored** message. The main purpose of the Data Delete command is to selectively free up memory space for new tests. Do not confuse Data Delete with Data Erase, which wipes out all runs of data from memory. See also Data Free, Data Renumber, and Data Erase.

2.3.7 Data Renumber

Select >Data Renumber to renumber remaining runs into consecutive order after deleting one or more runs. This allows you to free up run numbers for new runs to be added, which is necessary when the run number approaches 99.

Say you have used all 99 runs and you wish to clear out some space for new runs. Furthermore, you have decided that you no longer need the data from runs 01 to 10. Delete these runs using Data Delete. Now select >Data Renumber to renumber runs. Runs 11 to 99 become runs 01 to 89, leaving 90 to 99 free to take new data.

The Data Renumber command does not free up memory space, only run numbers. The 999 cycle memory limit remains whether or not all 99 runs have been used.

2.3.8 Data Erase

Select >Data Erase only if you wish to completely wipe all data from the entire RAD7 memory. Data Erase deletes all runs and resets the current run/cycle number to 0101.

Select >Data Erase. The RAD7 will ask for confirmation:

Erase all Tests? No

Press [→] to find Yes. Press [ENTER] to complete the erasure. Use with caution!

2.4 Setup

The Setup group of commands configures the RAD7 to perform tests according to your needs. The RAD7 remembers all Setup parameters when it is turned off, so access the Setup commands only to change parameters.

Setup includes a 1-step >Setup Protocol command to configure the most frequently used parameters (Cycle time, Recycle number, Mode setting, and Pump setting) according to preset "protocols". These standard preset protocols include (None), Sniff, 1-day, 2-day, Weeks (that is, indefinite), User (which lets you preset your own), Grab, Wat-40 and Wat250 (for use with the RAD H₂O), and Thoron.

The special command >Setup SavUser defines the user protocol according to the current parameter settings.

2.4.1 Setup Protocol

Select >Setup Protocol to automatically load in a group of predefined Setup parameters under one of the standardized protocols, or the User protocol. If you do not wish to select a protocol, you may abort the command by pressing the menu key, and no parameters will be changed.

Table 2.4.1 Preset protocols

	Cycle	Recycle	Mode	Thoron	Pump
Sniff	00:05	00	Sniff	Off	Auto
1-day	00:30	48	Auto	Off	Auto
2-day	01:00	48	Auto	Off	Auto
Weeks	02:00	00	Auto	Off	Auto
User	xxx	xxx	xxx	xxx	xxx
Grab	00:05	04	Sniff	Off	Grab
Wat-40	00:05	04	Wat-40	Off	Grab
Wat250	00:05	04	Wat250	Off	Grab
Thoron	00:05	00	Sniff	On	Auto

A Recycle number of 00 indicates indefinite test length. The test ends only if the operator intervenes, or if the RAD7 memory fills.

2.4.2 Setup Cycle

How long a test do you want, and how often do you want the RAD7 to take a reading (a cycle)? A typical radon test is made up of many cycles.

Select `>Setup Cycle` to adjust the Cycle time, or integration time, for a single radon reading. The Cycle time can be adjusted anywhere from two minutes to 24 hours. For continuous monitoring, the Cycle time is usually 30 minutes or longer. For radon sniffing, the Cycle time is usually 5 or 10 minutes. For thoron sniffing, the cycle time may be as little as 3 minutes.

Upon selection of `>Setup Cycle`, push `[ENTER]` and you will see something like this:

```
Cycle:    00:30
```

First, select the number of hours (00 to 23), and press `[ENTER]`. Then select the number of minutes (00 to 59) and press `[ENTER]`.

Remember that a run includes many cycles in sequence, and the total duration of the radon test is determined by the Cycle time multiplied by the number of cycles, or Recycle number. To adjust the Recycle number, use the `>Setup Recycle` command.

2.4.3 Setup Recycle

How long a test do you want, and how often do you want the RAD7 to take a reading (a cycle)? You determine the length of your test by choosing both the length and number of cycles. If you make a reading every 30 minutes, you will need 48 cycles to get a 24-hour test. In this case, 48 is the Recycle number.

Use `>Setup Recycle` to set the total number of cycles in a complete run. Multiply Cycle time by Recycle number to determine the total duration of the run.

Select `>Setup Recycle`. Push `[ENTER]`

and you will see something like this:

```
Recycle:   48
```

Use the arrow keys to change the Recycle number, and press `[ENTER]` to complete the selection. Recycle number may be set from 00 to 99.

If the Recycle value is set to a number greater than 00, the RAD7 test will have a finite duration. When it is complete the instrument will go to sleep, and the screen will say:

```
Good Night. Hit  
MENU to resume.
```

If 00 is selected, then the number of cycles is assumed to be infinite. Select 00 if you want the RAD7 to collect data indefinitely, or to go beyond the 99th cycle. After the 99th cycle, the RAD7 will automatically start a new run, and continue collecting data. Data collection will stop only when the operator intervenes, or when the RAD7 memory completely fills up with 999 cycles.

2.4.4 Setup Mode

Select `>Setup Mode` to change the RAD7 mode of operation. Five modes are available: Sniff, Auto, Wat-40, Wat-250, and Normal.

SNIFF mode is used when you want to follow rapid changes of radon concentration. In SNIFF mode, the RAD7 achieves rapid response to changing radon levels by focusing on the 3-minute polonium-218 alpha peak, calculating the radon concentration on the basis of this peak alone.

In NORMAL mode, the RAD7 achieves higher statistical precision by counting both polonium-218 and polonium-214 alpha peaks.

AUTO mode automatically switches from SNIFF mode to NORMAL mode after three hours of continuous measurement. This allows time for the equilibrium of the longer-lived radon daughter isotopes. The earliest part of the run will have the benefit of the SNIFF mode's quick response, while the latter parts of the run will benefit from the NORMAL mode's superior statistical precision.

We recommend that the AUTO mode be used for all screening tests and any tests to measure the average concentration over a period of time. With the AUTO mode there is no need to throw away the first three hours of data, or to calculate adjustments to correct for disequilibrium. The

mean concentration reported in the run summary should accurately reflect the actual mean. SNIFF mode should be used where the goal is to follow, and measure, rapid changes in the radon concentration.

Wat-40 and Wat250 make calculations of the radon concentration in 40 mL and 250 mL water samples, respectively. They require the RAD H₂O water accessory kit to aerate the water under the controlled conditions necessary for these calculations.

2.4.5 Setup Thoron

Select >Setup Thoron. Push [ENTER] and you will see:

Thoron: Off

Use the arrow keys to toggle between On and Off, and press [ENTER] to complete the selection.

With Thoron On, the calculated thoron concentration will be printed during continuous data logging, or in subsequent printing of data. Also, if the pump is in AUTO mode, it will be directed to pump continuously during the thoron measurement.

Note that the thoron calculation assumes a standard setup for the measurement. A small drying tube, three feet of vinyl tubing, and the inlet filter, should be used. Typically, the small drying tube is held in the hand, and used as a wand. (See Section 4.5.9 for details.) If the laboratory drying unit is used instead of the small drying tube, it creates additional sampling delay, which allows more of the thoron to decay before reaching the RAD7, reducing the sensitivity of the measurement to about half that of the standard setup.

The only difference between Sniff protocol and Thoron protocol is that this setting, 'Setup Thoron', is Off in Sniff protocol and On in Thoron protocol (See Setup Protocol, Chapter 2.4.1).

2.4.6 Setup Pump

Select >Setup Pump to change the Pump setting. Four settings are available: Auto, On, Grab, and Off.

When the pump is set to Auto, it will switch on and off according to a predetermined pattern that allows for sufficient sampling of air while conserving battery charge and pump wear.

Specifically, the pump will switch on for five minutes at the beginning of each new test cycle, to ensure a good initial sample. The pump will then operate on a schedule of one minute on, four minutes off, and this pattern will repeat until the end of the cycle. However if at any point the humidity reaches 10% or higher during the off period, the pump will turn back on, running for at least one minute. If the humidity is under 10% after that minute, the pump will shut off and wait for four minutes, or until the humidity creeps back up to 10%.

When the pump is set to On, it will run continuously, whether the RAD7 is counting (Live) or not (Idle).

Grab initiates a standard grab sampling sequence at the beginning of a run. When you start a new run with the pump set to Grab, the pump will run for exactly five minutes. This is followed by a five-minute equilibrium delay, after which the counting period begins. The pump does not run at all during the counting period. As usual, you can determine the length of the count period by multiplying the cycle time by the recycle number. The total time to complete a test is the pump sample time (5 minutes) plus the delay period (5 minutes) plus the count period. Note that the Grab, Wat-40 and Wat250 protocols, under >Setup Protocol, above, all use this pump setting.

Off means the pump is always off.

Use Auto pump setting for routine radon testing. The RAD7 has been factory calibrated with the pump in this setting.

2.4.7 Setup Tone

Select >Setup Tone to choose the audible tone type. Three settings are available: Off, Chime, and Geiger. Off means the beeper remains quiet. Chime means the beeper will sound only at the end of a cycle, and is otherwise silent. Geiger means the beeper will emit a chirp whenever a

particle is detected, much like the familiar Geiger counter. But unlike a Geiger counter, the pitch of the chirp depends on the energy of the alpha particle. A trained ear can distinguish "old" radon from "new" radon by the sound of the chirps. The thoron beep is the highest pitch. In the Geiger setting, anyone will recognize a radon "gusher" by the rapid-fire chirping the RAD7 produces.

2.4.8 Setup Format

Select `>Setup Format` to change the way data are printed out. Four settings are available: Short, Medium, Long, and Off.

Short causes the RAD7 to print results in an abbreviated form. Three lines of printed text contain a cycle's most important data: the run/cycle number, radon concentration and two-sigma uncertainty, units and mode, time and date, temperature, relative humidity (internal), and battery voltage.

Medium and Long printouts include seven additional lines of data: total counts, livetime, and counts per minute for five alpha energy windows. These seven lines are the raw data from which the radon concentrations shown in the first line of the printout are calculated.

The Long format, when printing from a test in progress (Live) includes a graph of the alpha energy spectrum. Since spectra cannot be saved to long-term memory, the spectrum will not be printed when retrieving past data.

Off means that no data will print out at the end of each cycle, but the summary and cumulative spectrum will print at the end of the run (if the printer is set up and switched on).

2.4.9 Setup Units

Select `>Setup Units` to change the measurement units with which the RAD7 reports radon concentration and temperature. First, enter the radon concentration unit (pCi/L = picoCuries per liter, Bq/m³ = Becquerels per cubic meter, cpm = counts per minute, #cnts = number of raw counts). Next, enter the temperature unit (F = degrees Fahrenheit, C = degrees Celsius or Centigrade).

PicoCurie is the favored unit of radon activity in the U.S., while Becquerel is the favored unit in Europe and Canada. 1 pCi/L equals 37 Bq/m³. "Counts per minute" is the direct output of the RAD7 while "number of raw counts" is the raw direct output. With livetime, mode, and calibration factor, one can convert from any of these units to any other, but it is usually easier to let the RAD7 do the work.

The choice is retroactive. Change the unit using the `>Setup Units` command, then print out the same data. Everything will print as before, but in the new units.

2.4.10 Setup Savuser

Select `>Setup SavUser` to program the special User protocol according to the present Setup parameters. You must answer Yes, and push [ENTER], to confirm that you wish to change the User protocol. The purpose of this command is to give you an opportunity to customize a protocol according to a set of favorite parameters. Thereafter, it's a cinch to return to the same set of parameters; simply select `>Setup Protocol [→] User`.

The User protocol has many possible applications. One RAD7 owner uses her instrument for 3-day screening tests. To make the setup easy, she programs the User protocol with the parameters for a 72-hour screening test. To do this, she first sets up all the parameters as she wants them. She enters 2 hour for the Cycle time, 36 for the Recycle number, Auto for the Mode setting, Off for thoron, and Auto for the Pump setting.

Finally, to program the User protocol with these values, she selects `>Setup SavUser` and answers Yes to the confirmation question. After that, she can easily return to the 72-hour protocol by selecting `>Setup, Protocol, User`, any time she wishes.

2.4.11 Setup Clock

Use `>Setup Clock` to change time zones, go in or out of daylight savings time, or to synchronize the RAD7 clock with another clock. The Real Time Clock (RTC) will maintain time-of-day and

calendar date for as long as 10 years, and is accurate to within one minute per month at room temperature.

Select `>Setup Clock` to set the time and date of the RAD7 clock. You will see:

Time: 15:05:34

The time is listed with hours first, then minutes, then seconds. The arrow keys can be used to change each value. Holding an arrow key down will cause the number to change quickly. The cursor (blinking square) will start on the hour. Set the correct number with the arrow keys, then push [ENTER] to confirm. Do the same for the minutes and seconds.

Next you should see:

Date: 13-DEC-11

Dates are listed with the day of the month first, then the month, then the year. As with the RAD7 clock, the date is set by using the arrow keys to change each value. Press [ENTER] after each figure is set to move on to the next.

2.4.12 Setup Review

The `>Setup Review` command allows you to display and print a listing of the current instrument settings, including Date and Time, Protocol, CycleTime, Recycle, Mode, Thoron, Pump, Tone, Format and Units. Thus you can check that the instrument is set up properly, and confirm this, in hard copy, right on the data printout.

2.5 Special

The Special menu offers access to a selection of additional commands, provided by the RAD7's RADLINK remote control software. If for any reason RADLINK is not present, you will see the following when entering the Special menu:

```
Not installed.  
Install? No
```

Use the arrow keys to toggle between Yes and No. If you confirm Yes, the RAD7 will sit, waiting for a data string at the RS232 port. If necessary, DURRIDGE will complete this RADLINK

installation process when the RAD7 is returned for calibration.

If RADLINK is installed, then `>Special` opens a menu of special commands available from the keypad of the RAD7. All the commands, both standard and special, will also be accessible from a remote PC, either directly, or by modem connection.

The following command set are those available with RADLINK versions 0252 and later. Earlier versions will have a subset of these.

2.5.1 Special Ident

Output the RAD7 identification sequence, including firmware version, hardware model number, unit serial number, and last calibration date.

The firmware version is expressed in the format `3.1a 151208`, with the "3.1a" representing the firmware version number, and the "151208" indicating the firmware release date (e.g. December 8, 2015). This is not to be confused with the RAD7's response to the Special Version command, which outputs the RADLINK version number as explained below.

2.5.2 Special SPrOn

Re-direct subsequent output from the infrared printer to the serial port. In other words, everything that would ordinarily be printed will shoot out the serial port, but nothing will be printed, even when you say "Print". One reason to use this might be to move the data very quickly into a computer without waiting for the (slow) infrared printer link. You can cancel the re-direction order and restore the use to the infrared printer with the "Special SPrOff" command. When you turn off the RAD7 and turn it on again, it always restores output to the infrared printer.

Note that the spectra that would be printed on the infrared printer are not sent to the serial port by Special SPrOn.

2.5.3 Special SPROff

Cancel the printer to serial port re-direction, so that output can go to the printer again.

2.5.4 Special SetBaud

Set the serial port bit rate. The following standard speeds are available: 300, 600, 1200, 2400, 4800, 9600, and 19,200 bps. The other communication settings are always 8 bit, no parity, and 1 stop bit. The RAD7 remembers the serial port speed when you power down. Note that at the highest serial speed settings the RAD7 may not be able to keep up with incoming character strings unless the characters are "paced". An "echo-wait" strategy will avoid this problem. Also note that the RAD7 recognizes XOFF/XON flow control protocol when sending data.

2.5.5 Special Status

Gives a snapshot of the RAD7 status page, including run and cycle numbers, countdown timer, last reading, temperature, humidity, and so on. This is basically the same information that you can get with "Test Status", but it gives the data in one shot and does not continue to update every second.

2.5.6 Special Start

Same as "Test Start" (see Chapter 2.2.2, Test Start), but does not go into a continuously updating status display.

2.5.7 Special Stop

Same as "Test Stop" (see Chapter 2.2.2 Test Stop).

2.5.8 Special Comspec

This command outputs the current test data in the same manner as the Test Com command, but it also provides the content of the alpha energy spectrum. The spectrum information is delivered as a column of either 200 or 300 numerical values, depending on the version of RADLINK installed on the RAD7. If an older version of RADLINK is installed, 200 values will be received, with each value representing the number of counts detected

at a specific energy level during the current cycle. If a new version of RADLINK is installed, 300 values will be received, encompassing the entirety of the RAD7's most recent run. In the latter case the numerical values are encoded into a hexadecimal format. CAPTURE can parse either format to generate a visual spectrum histogram.

2.5.9 Special ComAll

Output the complete set of RAD7 test data (up to 1000 readings) to the serial port in comma delimited format. Each row of data represents one test cycle. See Table 6.3.3 for information on parsing the row content.

2.5.10 Special SPrAll

Output complete set of RAD7 test data (up to 1000 readings) to the serial port in standard, readable 24 column printer format, without affecting the infrared printer.

2.5.11 Special S-Load

Used to load special software into the RAD7 through the serial port.

2.5.12 Special Version

Output the RADLINK version number, which is a three digit integer. Each firmware version requires a specific RADLINK version: firmware version 2.5f uses RADLINK 253, firmware version 3.0f and 3.0g use RADLINK 301, and firmware version 3.1a uses RADLINK 311.

2.5.13 Special Model

Output the RAD7 hardware model number. Newer RAD7s have higher model numbers, due to changes in component designs. However all RAD7s with model numbers 711 and higher, with the same firmware, have the same functionality.

2.5.14 Special Serial

Output the RAD7 unit serial number.

2.5.15 Special Beep

The RAD7 gives an audible beep tone. Does not make any sound if the tone setting is "Off".

2.5.16 Special Relays

With the aid of the optional Relay Box accessory, the RAD7 can be configured to activate warning lights, alarms, and other external devices when the radon concentration meets or exceeds a certain level.

The Relay Box offers two relays which may be set or reset according to a pair of individually set thresholds and the measured radon concentration. The RAD7's Special Menu facilitates this with a selection of Relays commands: 'Level1', 'Level2', 'Enable', and 'Disable'. Use the arrow keys to scroll between these commands. Level1 permits the user to set a level, at which the RAD7 will turn on Relay 1, and below which it will turn Relay 1 off. Level2 does the same for the second relay. 'Enable' causes the function to go into effect. 'Disable' stops the RAD7 from sending any commands to the relays.

Note that the relay settings only apply to radon concentrations; thoron is not checked. Moreover the relay settings do not work for Grab samples. The RAD7 may be in either Sniff or Normal mode. The Level1 and Level2 relay values use whichever concentration unit has been specified in the Setup menu. Changing the unit type does not automatically update the relay values.

The relay trigger conditions are checked after each test cycle ends and the end-of-cycle results have been printed, but before the graph is printed. A relay is actuated if the radon concentration meets or exceeds the corresponding user-specified level, and the relay is deactivated when it falls below that threshold.

2.6 Infrared Printer

The RAD7 uses an infrared link to print to the supplied printer. Note that all references to the RAD7 printer in this manual apply to the Omniprint OM1000 printer and to the Chamjin I&C New Handy printer, model 700-BT. The most significant difference between these printers and

the previously supplied, now obsolete HP 82240B printer is that the HP printer had to have external 12V power supplied in order to stay awake for more than 10 minutes between printouts. The newer printer models do not accept external power.

The printer should be placed on the RAD7 face plate, between the green lines as indicated. Because the print mechanism uses thermal technology, only thermal paper will work. Detailed instructions are provided in Appendix 1 at the end of this manual.

If the printer is placed in position and switched on before switching on the RAD7, it will print out identity information and a review of the setup, before the RAD7 goes to >Test. It is good practice to do this if the measurement data are to be printed out, because it automatically provides a header for the data printout, with instrument identity and setup as shown.

```
DURRIDGE RAD7
Vers 3.1a 151208
Model 716
Serial 00512
Calib 20-MAY-17
Last used
    FRI 21-MAY-17 17:30

Current settings
    FRI 21-MAY-17 19:09

Protocol: 2-Day
Cycle: 00:60
Recycle: 48
Mode: Auto
Thoron: Off
Pump: Auto
Tone: Geiger
Format: Short
Units: pCi/L °C
```

At the end of every cycle, the printer will print the data of that cycle, according to the format setting. In short format, it prints:

```
0102 2.69 ± 0.73 p Sniff
    FRI 21-MAY-17 19:41
    26.8 °C RH: 7% B:7.06V
```

With the run and cycle number, radon level, two-sigma uncertainty, units and mode in the top row, date and time in the second, and temperature, humidity and battery voltage in the third.

Medium format adds:

Total Counts: 357.
Livetime: 28.2 min
A: 5.74" 0.98 cpm 45.4%
B: 0.32" 0.29 cpm 2.5%
C: 6.13" 1.01 cpm 48.5%
D: 0.00" 0.14 cpm 0.0%
O: 0.46" 0.34 cpm 3.7%

Where the lifetime is the actual time spent waiting for an event, slightly less than the elapsed time. The windows, A, B, C, D, and all the rest, O (for "other"), correspond to the different alpha energies in the spectrum.

Long format adds, to the short and medium formats, a printed spectrum of the alpha energies, as shown on the following page.

At the end of a run, the printer will print a summary, see figure in Chapter 1.4. It will include an average of the radon concentrations, the high value, low value and standard deviation. These are followed by a bar chart, showing the variation of radon concentration from cycle to cycle throughout the run. Finally, it prints a cumulative spectrum, showing the distribution of energy of all the alpha decays counted during the run. This spectrum is very informative. It gives a good indication of the condition of the instrument and the quality of the measurement. It is a useful habit to look at the cumulative spectrum from time to time, just to be sure that it has not changed in character.

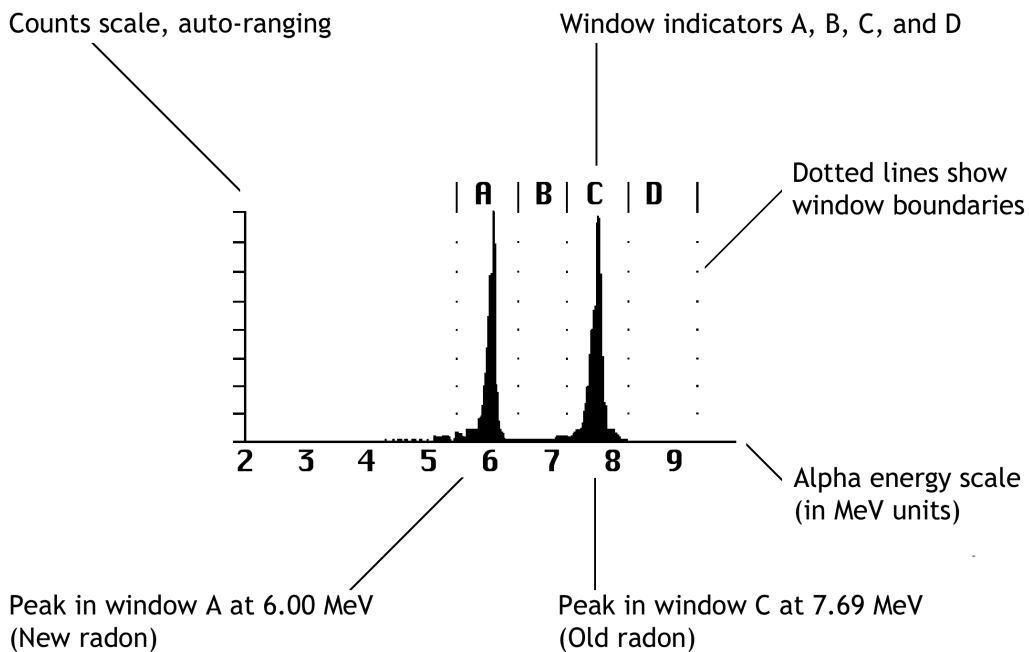

Alpha Energy Spectrum

3 BASICS OF RAD7 TECHNOLOGY: HOW IT WORKS

3.1 Introduction

This chapter deals with a number of fundamental facts concerning radon and thoron, their measurement in general and their measurement, specifically, with the RAD7. It is not necessary to master the underlying physics to become proficient in the use of the instrument, but some understanding of what is happening is helpful.

It is recommended that the user read the entire manual, including this chapter, on first acquiring the instrument, and then again after gaining some experience in the field.

3.2 Radon and Thoron Decay Chains

When the earth was formed, billions of years ago, there were probably many radioactive elements included in the mix of material that became the earth. Three, of interest, have survived to this day, namely uranium-235, uranium-238, and thorium-232. Each has a half life measured in billions of years, and each stands at the top of a natural radioactive decay chain.

A radioactive element is unstable. At some indeterminate moment, it will change to another element, emitting some form of radiation in the process. While it is impossible to predict exactly when the transformation of an individual atom will take place, we have a very good measure of the probability of decay, within a given time slot. If we started with a very large number of atoms of a radioactive element, we know quite precisely how long it would take before half those atoms had decayed (though we could not identify the decaying atoms individually, beforehand). This time interval is called the half-life of that particular element.

A natural radioactive transformation is accompanied by the emission of one or more of alpha, beta or gamma radiation. An alpha particle is the nucleus of a helium atom. It has two protons and two neutrons. Thus an 'alpha decay' will reduce the atomic number by two and reduce the atomic weight by four. A beta particle is an

electron, with its negative charge. Thus a beta decay will increase the atomic number by one and leave the atomic weight unchanged. A gamma ray is just a packet of energy, so a gamma decay by itself would leave both the atomic number and atomic weight unchanged.

A decay chain is a series of distinct transformations. A uranium-235 nucleus goes through a series of 11 transformations to become stable lead-207. A thorium-232 nucleus goes through 10 transformations to become stable lead-208. And a uranium-238 nucleus goes through 14 transformations to become stable lead-206.

All three of these natural decay chains include isotopes of radon. Radon-219, or "actinon", is a link in the uranium-235 chain. You will probably never encounter actinon in indoor air, due to its scarcity and short half-life. Radon-220, or "thoron", is part of the thorium-232 decay chain. You will sometimes encounter thoron in indoor air, particularly near radon entry points, and, more often, in soil gas. Radon-222, or familiar "radon", is part of the uranium-238 decay chain. You will almost always be able to detect radon-222 in indoor air, outdoor air, and soil gas.

The radon isotope is the first element, in each of the decay chains, that is not a metal. It is, in fact, an inert, or "noble", gas. So it can escape any chemical compound its parent (radium) was in, and diffuse into the air.

To focus on these inert gases, the thoron and radon decay chains, shown below, are those parts of the thorium-232 and uranium-238 decay chains that include just these radioactive gases and their short-lived progeny.

It may be noted that only alpha decays change the atomic weight, and then only in steps of four. Thus the atomic weights of all the members of the radon-220, thoron, decay chain are divisible by four, while none of the radon-222 are.

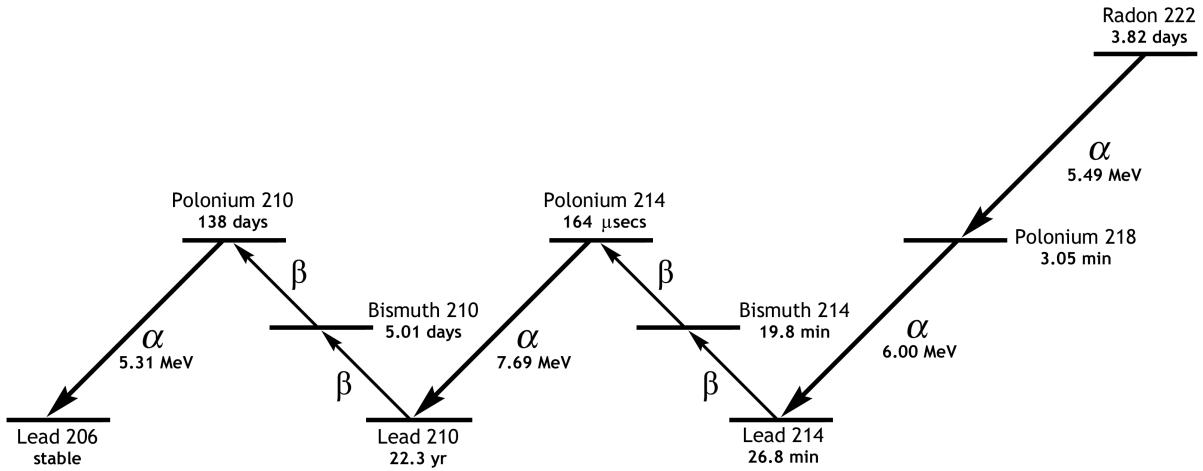

Radon Decay Chain

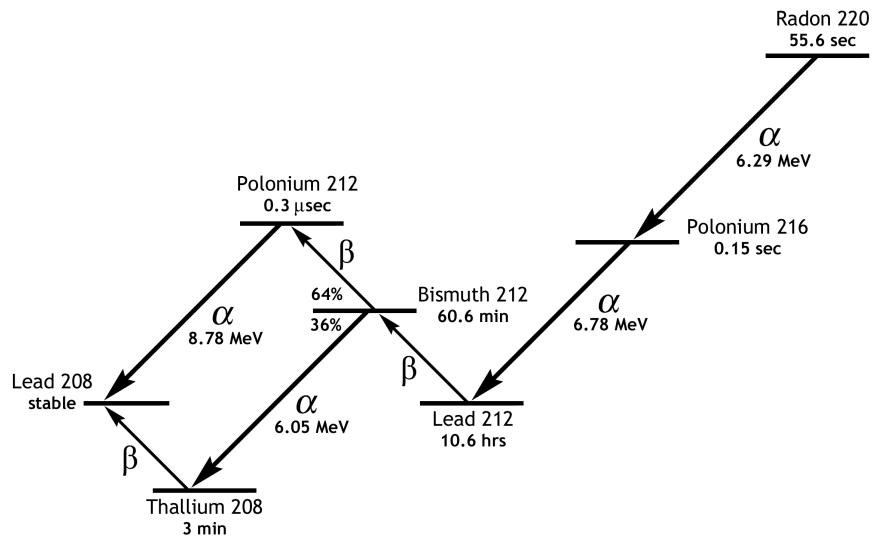

Thoron Decay Chain

3.2.1 Radon-222 (Radon)

Every nucleus of radon-222 eventually decays through the sequence polonium-218, lead-214, bismuth-214, polonium-214, and lead-210. With each transformation along this path the nucleus emits characteristic radiations: alpha particles, beta particles, or gamma rays, or combinations of these. The RAD7 was designed to detect alpha particles only, so we will emphasize alpha radiation .

Radon-222 is an inert gaseous alpha-emitter that does not stick to or react with any materials. It has a half-life of 3.82 days. A particular radon nucleus may decay at any time, but it is most likely to decay between now and 8 days (two half-lives) from now. When the radon nucleus decays, it releases an alpha particle with 5.49 MeV of energy, and the nucleus transforms to polonium-218. The polonium nucleus can never go back to radon again. Polonium atoms are metals and tend to stick to surfaces they come in contact with, e.g., a dust particle in the air, or a wall, or the inside of your lung!

Polonium-218 nuclei have a short half-life, only 3.05 minutes, which means that most of them will decay within 6 minutes of their formation. The average polonium-218 nucleus lives for only 4.40 minutes before it decays (1.443 times the half-life gives the mean life). Like radon, polonium-218 emits an alpha particle when it decays, but with an energy of 6.00 MeV rather than radon's 5.49 MeV.

When polonium-218 decays, it transforms to lead-214, also a radioactive solid. But lead-214 has a half-life of 26.8 minutes, and it emits beta radiation rather than alpha radiation. When lead-214 decays, it becomes bismuth-214, also a radioactive solid and a beta emitter. Bismuth-214 has a half-life of 19.8 minutes, and transforms to polonium-214 when it decays.

Polonium-214 is a bit different. It has a half-life of only 164 microseconds (0.000164 seconds) and it emits a 7.69 MeV alpha particle when it decays. When polonium-214 decays, it becomes lead-210, which has a half-life of 22.3 years. This means that an average lead-210 nucleus takes 1.443 times 22.3 years, or 32.2 years, to decay. Because of its long half-life, we usually ignore lead-210 as a factor in

radon measurement, though it adversely affects the background of some instruments (not the RAD7).

Lead-210 eventually undergoes beta decay to Bismuth-210 which quickly (5 days half-life) undergoes a further beta decay to Polonium-210. Polonium-210 has a half-life of 138 days and decays with a 5.30 MeV alpha particle to Lead-206, which is stable. The 5.30 MeV alpha particle from Polonium-210 creates unwanted background in most radon monitors, but not in the RAD7.

3.2.2 Radon-220 (Thoron)

Similarly to radon-222, every radon-220 (thoron) nucleus eventually decays through a sequence of 5 transformations to Lead-208. The main distinction is the very different half lives involved.

Thoron has a half life of only 55.6 seconds. It emits a 6.29 MeV alpha particle and transforms to polonium-216, which in turn has only a 0.15 second half-life before emitting a 6.78 MeV alpha particle and transforming to Lead-212.

Lead-212 hangs around for a long time, with a half-life of 10.6 hours. It transforms by beta decay to bismuth-212, which, in turn, has a half life of 60.6 min.

Bismuth-212 has a 2:1 split, with two thirds transforming by beta decay to polonium-212 and one third transforming by 6.05 MeV alpha decay to thallium-208. The polonium-212 decays immediately to lead-208, emitting an 8.78 MeV alpha particle in the process, while the thallium-208, with a half-life of 3 min, undergoes a beta decay to the same destination, lead-208.

3.3 Continuous Monitors

There are several types of continuous radon monitors on the market. Nearly all of these are designed to detect alpha radiation, but not beta or gamma radiation. Why? Because it is very difficult to build a portable detector of beta or gamma radiation that has both low background and high sensitivity.

Three types of alpha particle detectors are presently used in electronic radon monitors:

1. Scintillation cells or "Lucas cells"
2. Ion chambers
3. Solid state alpha detectors.

Each of these types has advantages and disadvantages relative to the others. All of these types can be used for low background alpha particle counting.

The DURRIDGE RAD7 uses a solid state alpha detector. A solid state detector is a semiconductor material (usually silicon) that converts alpha radiation directly to an electrical signal. One important advantage of solid state devices is ruggedness. Another advantage is the ability to electronically determine the energy of each alpha particle. This makes it possible to tell exactly which isotope (polonium-218, polonium-214, etc.) produced the radiation, so that you can immediately distinguish old radon from new radon, radon from thoron, and signal from noise. This technique, known as alpha spectrometry, is a tremendous advantage in sniffing, or grab-sampling, applications. Very few instruments other than the RAD7 are able to do this.

A distinction should be made between true, real-time continuous monitors, and other instruments and devices. With a continuous monitor, you are able to observe the variation of radon level during the period of the measurement. This can sometimes show big swings in radon concentration and may allow you to infer the presence of processes influencing the level. For good data, it is important that there be sufficient counts to provide statistically precise readings. Devices which give just a single, average reading, or whose precision is inadequate except after a long measurement time, are not, in this sense, continuous monitors.

Another important parameter is background. This is the reading given by the instrument when there is no radon in the air sample. For low level continuous monitoring, it is necessary that the background be extremely low and stable. Because of the high quality alpha detector, and unique, real-time spectral analysis, the RAD7 background

is vanishingly small, and is immune to the buildup of lead-210, which plagues other instruments.

3.4 Sniffers

Sniffing means taking quick, spot readings. Thus you can get a rough idea of the radon level, without waiting for a full, 48-hour, EPA protocol test. The technique is often used to locate radon entry points in a building.

Any fast-response, continuous radon monitor, with a pump, can be used for sniffing. However, there are some factors to consider: One is the rate of recovery after exposure to high radon levels. When the sniffer finds a radon gusher, the whole radon decay chain builds up inside the instrument, and the various daughters become well populated. If the sniffer now moves to a low level region, it will take many hours for the lead/bismuth/polonium-214 daughters to decay away. In the RAD7 this doesn't matter, because, in SNIFF mode, it looks only at the polonium-218 decays, and ignores the polonium-214 decays left over from previous sniffs. The polonium-218 has a three-minute half life, so the RAD7, sniffing for radon, has a 15 minute response time to both sudden increases and sudden decreases in level.

Unique to the RAD7 is the ability to sniff for thoron. Polonium-216 has a 150 ms half life, so the instrument response is virtually instantaneous. The only delay is the time required to put the air sample into the measurement chamber, which is about 45 seconds.

Another factor, when sniffing, is the vulnerability (of other instruments) to lead-210 buildup. Only with the RAD7 can you continue to sample high levels, without having to worry about increasing the background.

3.5 Working Level

Radon concentrations are determined by measuring the radioactivity of the radon or by measuring the radioactivity of the radon decay products. Instruments that measure radon decay products in the air are called "working level" monitors. Working level monitors sample air through a fine filter and then analyze the filter for

radioactivity. The radon progeny are metal and they stick to the filter and are counted by a working level instrument. Radon-222, an inert gas, passes through the filter, so it is not counted in such an instrument. Therefore, a working level instrument measures the radon progeny concentration (polonium-218, etc.), in the air, but not the radon gas concentration.

The RAD7, on the other hand, measures radon gas concentration. Radon daughters do not have any effect on the measurement. The RAD7 pulls samples of air through a fine inlet filter, which excludes the progeny, into a chamber for analysis. The radon in the RAD7 chamber decays, producing detectable alpha emitting progeny, particularly the polonium isotopes. Though the RAD7 detects progeny radiation internally, the only measurement it makes is of radon gas concentration.

In short, the RAD7 does not measure radon daughter concentrations (working levels), only radon gas concentrations.

3.6 RAD7 Solid-State Detector

The RAD7's internal sample cell is a 0.7 liter hemisphere, coated on the inside with an electrical conductor. A solid-state, Ion-implanted, Planar, Silicon alpha detector is at the center of the hemisphere. The high voltage power circuit charges the inside conductor to a potential of 2000 to 2500V, relative to the detector, creating an electric field throughout the volume of the cell. The electric field propels positively charged particles onto the detector.

A radon-222 nucleus that decays within the cell leaves its transformed nucleus, polonium-218, as a positively charged ion. The electric field within the cell drives this positively charged ion to the detector, to which it sticks. When the short-lived polonium-218 nucleus decays upon the detector's active surface, its alpha particle has a 50% probability of entering the detector and producing an electrical signal proportional in strength to the energy of the alpha particle. Subsequent decays of the same nucleus produce beta particles, which are not detected, or alpha particles of different energy. Different isotopes have different alpha energies,

and produce different strength signals in the detector.

The RAD7 amplifies, filters, and sorts the signals according to their strength. In SNIFF mode, the RAD7 uses only the polonium-218 signal to determine radon concentration, and the polonium-216 signal to determine thoron concentration, ignoring the subsequent and longer-lived radon daughters. In this way, the RAD7 achieves fast response to changes in radon concentration, and fast recovery from high concentrations.

3.6.1 RAD7 Calibration and Data Correction

The RAD7 depends on calibration to determine the radon and thoron concentrations it measures. Built into the RAD7 firmware are three sensitivities:

1. Sniff sensitivity, counting only 218-Po for fast response.
2. Normal sensitivity, counting both 218-Po and 214-Po decays for higher precision.
3. Thoron sensitivity, counting 216-Po decays for thoron.

In calibration, the RAD7 is exposed to a known concentration of radon (or thoron) and the count rates are measured. Your radon calibration certificate gives the two radon sensitivities.

For thoron calibration, a separate calibration letter gives the calibrated thoron sensitivity. If thoron calibration is not conducted, the thoron sensitivity is estimated to be half the radon Sniff sensitivity, which is usually a reasonable estimate. In either case, when making a thoron measurement the RAD7 has to be set up and used in Thoron Protocol for the thoron reading to be valid.

In addition to the bare count rates in the three windows, there are various corrections and calculations that may be applied to calculate more precise radon and thoron concentrations. Some of these corrections are made automatically by the RAD7 itself. Others are optionally applied using DURRIDGE's CAPTURE software, after the data has been downloaded onto your computer.

The RAD7's internal corrections and calculations are:

- a. Spill from window C into window B. This is important when measuring thoron in the presence of radon-222. The DURRIDGE calibration system has no thoron in the sample air and it is therefore easy, during calibration, to measure the spill and calculate it as a fraction of the count rate in window C.
- b. Bi-212 alpha decays occurring in the A window. This is important when measuring low radon concentrations in the presence of high thoron. The Bi-212 count rate is approximately half the Po-212 count rate, whose decays are in the D window. So, again, it is easy to measure the Po-212 count rate and use it to determine the Bi-212 count rate and consequently the correction to be applied to the 218-Po count rate in window A.
- c. In WAT-40 and WAT250 protocols (used when recording RAD H₂O data), the RAD7 calculates the radon concentration of a water sample based on the radon concentration in the air loop. A known calibration factor is applied to achieve the necessary conversion.

After RAD7 data has been downloaded onto a computer, the DURRIDGE CAPTURE software can perform additional calculations and corrections:

- a. B window to A window spill correction. This is important when measuring low radon levels in the presence of high thoron.
- b. Humidity correction. This is essential if the desiccant becomes completely hydrated during a measurement.
- c. Radon-in-water calculation. With the optional RAD AQUA and Radon-in-Water Probe, the equilibrium ratio between the radon concentration in the water and that of the air entering the RAD7 is a function of the temperature at the air/water interface. CAPTURE can be given the necessary temperature information via a data file produced by a temperature logger, or it can use the air temperature as measured by the RAD7, or it can be given a single temperature value.

This temperature information is then used along with the radon-in-air readings to calculate the radon concentration of the water.

- d. Meaningful thoron threshold: The spill from window C to window B produces counts that must be deducted from the B count rate before the thoron concentration can be determined, but those spill counts have statistical uncertainty. That means that a count rate in B that is slightly above the calculated spill from C may, in fact, be merely a statistical variation of the spill rather than actual thoron. The spill, therefore, increases the uncertainty in the thoron reading. CAPTURE calculates a 'meaningful thoron threshold', taking into account the statistical uncertainty in the spill, and will display this threshold on the graph if so instructed.
- e. Forced Sniff mode: For long-term measurements, the RAD7 is normally put in Auto mode, in which the measurement starts in Sniff mode so as to achieve a fast initial response, before automatically switching to Normal mode after three hours, when the 214-Po decays have nearly reached equilibrium with the radon concentration. This assumes that the radon concentration is steady. If it appears that rapid changes in radon concentration were taking place, the user can, in CAPTURE, force the graph to display the data as if the RAD7 stayed in Sniff mode throughout the measurement, and thus see the rapid changes with a measurement time constant of just 12 minutes.

3.7 RAD7 Spectrum

The RAD7 spectrum is a scale of alpha energies from 0 to 10 MeV. Of particular interest are the radon and thoron daughters that produce alpha particles in the range of 6 to 9 MeV.

When the radon and thoron daughters, deposited on the surface of the detector, decay, they emit alpha particles of characteristic energy directly into the solid state detector. The detector produces an electrical signal. Electronic circuits amplify and condition the signal, then convert it to digital form. The RAD7's microprocessor picks

up the signal and stores it in a special place in its memory according to the energy of the particle. The accumulations of many signals results in a spectrum.

The RAD7 divides the spectrum's 0 to 10 MeV energy scale into a series of 200 individual counters, each representing a 0.05 MeV channel. Whenever the RAD7 detects an alpha particle, it increments one of these 200 counters by one. Every so often, the RAD7 manipulates, condenses, prints out and stores data to long-term memory. Then it resets all 200 counters to zero, and begins the process anew.

The idealized spectrum of a 6.00 MeV alpha emitter looks like a single needle-thin spike at exactly 6.00 MeV.

Although the RAD7 approaches this ideal, the actual spectrum shows a broadened peak centered at or near 6.00 MeV with a characteristic "tail" that stretches into lower energy channels. Electronic noise in the detector and amplifier causes the peaks to widen, while alpha particles that enter the detector at glancing angles cause the tail. Higher than normal operating temperatures tend to increase electronic noise, and so increase the width of the peaks.

A combination of different alpha emitters appears on the spectrum as a series of different peaks. For example, a combination of equal amounts of Po218 and Po214 (as would occur in the case of radon daughter equilibrium) appears as twin alpha peaks. One peak (Po218) is centered at 6.00 MeV, while the other (Po214) is centered at 7.69 MeV.

The second example spectrum, shown in Chapter 3.13, is the characteristic signature of radon at equilibrium with its alpha emitting daughters. We would expect to see a spectrum like this after several hours at a constant radon level. The 5.49 MeV alpha particle directly emitted by radon-222 does not appear on the RAD7 spectrum, because it was created in the air, not on the surface of the detector. The radon-222 atom is inert and electrically neutral, and cannot be attracted to the solid state detector. Only after it decays to polonium-218 does the atom become positively charged and is thus driven to the detector surface.

The RAD7 spectrum shows radon daughters, but not radon itself. Do not confuse the RAD7's spectrum with that of a working level instrument. The alpha peaks may appear the same, but the RAD7 is really measuring radon gas, not working level.

3.8 Windows

The RAD7 groups the spectrum's 200 channels into 8 separate "windows" or energy ranges. Window A, for example, covers the energy range of 5.40 to 6.40 MeV. So window A includes the 6.00 MeV alpha particle from polonium-218. The first step toward converting raw spectral data to radon measurement is to add up all the counts in each window and divide by the detector "lifetime" or duration of active data collection. The RAD7 microprocessor does this task and stores the results to memory in this form. You can recall and print window data from past measurements. The RAD7 adds windows E, F, G, and H together to form window O (for "other") before storing the data to memory. Spectrum printouts clearly mark windows A, B, C, and D with dotted lines.

Each window's function:

- A. Radon Sniffer Mode counts. The total counts of alpha particles from the 3-minute, 6.00 MeV, Po218 decay.
- B. Thoron 1 Window. The total counts in the region of the 0.15 second, 6.78 MeV decay of Po216. This window lies between windows A and C of the radon groups and may have some counts from spill-over from adjacent windows.
- C. Radon Po214 counts. The total counts of the 7.69 MeV alpha particles from the decay of the great-great granddaughter of radon, which has an effective half-life of nearly an hour.
- D. Thoron 2 Window. The total counts in the region of the effective 8.78 MeV decay of Po212, which has a half-life of about 10 hours.
- E. High Energy Window. A diagnostics window that normally has close to zero counts. If the counts in this window are a large fraction of the counts in A or B or C or D, the RAD7 is probably not working properly.

- F. Low Noise counts. A diagnostics window that gives the total counts in the first 10 channels. The count rate in Window F is a measure of the noise in the system. The counts may be high if the RAD7 is operated at very high temperatures.
- G. Medium Noise counts. A diagnostics window that gives the total count in the region around channels 30 to 40. Window G normally has few counts, even when Window F shows a high count rate.
- H. High Noise or Po210 Window. The total counts in the region of the 5.31 MeV alpha particle due to Po210 (polonium-210), the grand-daughter of Pb210 (lead-210). Since lead-210 (22 year half-life) results from the decay of the radon progeny we measure, this isotope will build up on the detector's sensitive surface through sustained measurement of very high radon concentrations, or many years of normal use. This window is not used in calculating radon levels, so the RAD7 will function well even with this isotope present, and the background will not be affected.
- O. Composite window for "Others". The RAD7 groups windows E, F, G, and H together to form the composite window O. Window O catches all the counts that did not go into the major windows A, B, C, and D. If window O consistently receives more than 30% of the total counts, you should inspect the spectrum printout for signs of trouble.

3.9 Isotope Equilibrium

Take a RAD7 that is completely clean, with no radon or daughters inside. What does the detector see? Close to nothing. Less than one alpha count per hour, due to unavoidable contamination of the materials of the instrument's construction. That is the instrument's intrinsic background. It is ignored by most people as of no consequence. Intrinsic background may add 0.01 pCi/L to a typical measurement, far below the radon concentration of outdoor air (usually 0.10 to 1.00 pCi/L).

Now introduce some radon into the RAD7. What do you see? At first, maybe nothing. But within a

few minutes, you begin to get counts in the A window. The RAD7 chirps merrily with each count. That's polonium-218, a result of the decay of radon-222 within the RAD7 sample chamber.

For the first 5 minutes or so, the count rate increases, then begins to approach a steady level. After about 10 minutes, we say that the polonium-218 daughter has reached close to equilibrium with the radon-222 parent.

Equilibrium is when the activity of the daughter stabilizes, neither increasing or decreasing. At this point, nearly all of the counts land in window A, and you see a single peak in the spectrum printout.

But the total count rate is still increasing, more slowly now. You begin to see counts appear in window C. Just a few, but more and more of them over the course of the next hour or two. After 3 hours or so, we reach full equilibrium, when the activities of all the daughters stabilize. Now the spectrum shows the characteristic twin peaks: polonium-218 in window A and polonium-214 in window C. The peaks are of almost identical size.

Now flush the RAD7 with fresh, radon-free air. The count rate in window A immediately begins to drop, just as fast as it rose when you first put the radon in. Without radon inside the RAD7, there is no source to replace the polonium-218 that decays. So the polonium-218 disappears with its characteristic half-life of 3.05 minutes.

After 3.05 minutes, the count rate in window A is half of what it was before. After 6.10 minutes, the count rate is half of that, or one-quarter of what it was before. You get the picture. After 10 minutes, there are hardly any counts at all in window A. Not so for window C, however. The spectrum still shows a single strong peak in window C.

The peak in Window C takes hours to disappear. After half an hour, the count rate in window C has not even halved. Polonium-214 may have a very short half-life, but its parents, lead-214 and bismuth-214, certainly don't. One has a half-life of 26.8 minutes, and the other has a half-life of 19.8 minutes. And they are sequential, which makes matters worse.

After you completely remove the radon, it may be a good 3 or more hours before the counts really die down in window C. We call window C the "old radon" window, since it represents counts from radon that was present in the RAD7 an hour or more before.

The effects of time in windows B and D, is similar, but much more pronounced. There is no delay in the RAD7 to polonium-216, so the count rate in window B is always in equilibrium with the thoron gas in the measurement chamber. In contrast, there is a 10-hour half life in the decay chain down to polonium-212, so it will take days for window D to reach equilibrium. Window D is, therefore, not counted when sniffing for thoron.

Note however, that for every 66 counts in window D, there will be 34 counts in window A. This is because of the two-way split from Bismuth-212. So, in calculating radon concentration, the RAD7 corrects the counts in window A for any thoron daughters that show in window D.

3.10 Modes: Sniff and Auto

"Old" radon daughters can be a real pain in the neck if you can't tell them apart from "new" radon. Most radon monitors don't help you at all here, but the RAD7 does. Waiting around for equilibrium is also a trial if it means sitting around for more than 2 hours. It is possible to calculate your way out of that problem, but the "old" radon always comes back to bite you. With the RAD7, the solution is simple and painless. Put the RAD7 in SNIFF mode.

SNIFF mode means that the RAD7 calculates radon concentration from the data in window A only. It ignores window C. Now the instrument responds to changes almost instantaneously. Hit a "hot spot?" No problem. In SNIFF mode, you can purge the sample chamber and, in 10 minutes, you're ready to measure low levels again with reasonable accuracy. You can move from point to point in minutes, looking for radon entry points in foundation cracks or test holes.

For continuous monitoring in one location over many hours, NORMAL mode is the way to go. NORMAL mode means that the RAD7 uses both radon peaks, A and C, to calculate concentration.

With double the count rate, you increase the precision of the measurement. In indoor environments, the radon concentrations rarely fluctuate quickly enough to justify using SNIFF mode for continuous monitoring.

The best of both worlds is provided by AUTO mode. Here, the RAD7 starts a test run in SNIFF mode, and then, after three hours, switches automatically to NORMAL mode. In this way, the first few cycles give readings without any bias from either "old" radon daughters left on the detector, or the slow build-up to reach equilibrium in window C, while the rest of the readings benefit from the higher precision given by twice the number of counts in each cycle.

For real-time monitoring, you are always better off to leave the mode in AUTO. The RAD7 is up to speed quickly, and is not influenced by old measurements. The final average of the run is therefore more accurate and more reliable.

CAPTURE can read a data file and force SNIFF mode presentation of the data, allowing the user to change the setting retrospectively.

Thus if, on looking at data taken in NORMAL mode, there is what appears to be a rapid change in radon concentration, changing to forced SNIFF mode presentation in CAPTURE will permit another look at the changes with better time resolution.

3.11 Background

"Background" in a radon detector refers to spurious counts that occur even in the absence of radon. Background can arise from the properties of the instrument or its components, other forms of radiation in the instrument's environment, or contamination of the instrument.

The RAD7's design makes it much less susceptible to background than other radon monitors, but one should still be aware of background in the RAD7 to avoid mistakes. The following list gives possible sources of background in the RAD7:

3.11.1 Short-lived Radon and Thoron Daughters

These are by far the most important components to background in the RAD7. Radon and thoron daughters that normally build up on the RAD7's solid state alpha detector continue to produce alpha counts for some time after the radon and thoron gases have been removed from the instrument. These lingering daughters can greatly confuse the result when you try to measure a low radon sample immediately after a high radon sample.

Many radon detectors require that you wait for the daughters to decay away (about three hours) before counting another sample. With the RAD7, however, you can go from high to low concentrations in a matter of minutes by counting in SNIFF mode, since the RAD7 distinguishes the different alpha-emitting daughters by their alpha energy. The resulting measurement responds with a 3.05 minute half-life. Thus, 10 minutes after the radon has been removed from the instrument, the background will have been reduced by more than 90% and you can count a new sample.

Thoron daughters are worse behaved than radon daughters. One thoron daughter, Lead-212, has a half-life of 10.6 hours, so that, with other radon monitors, if you build up huge amounts of this daughter, you may have to wait one to two days before using your radon instrument again. The RAD7's ability to distinguish daughters by their alpha energy almost always makes it possible to continue working.

3.11.2 Adsorbed Radon Gas

Radon atoms can adsorb on or absorb into internal surfaces of the RAD7, on the inside of tubing or on desiccant granules. This radon can stay behind after you purge the instrument, then desorb (or out-gas) from these surfaces and enter the sample cell volume. This effect is ordinarily negligible since only a small fraction of the radon ever becomes adsorbed. But at very high radon concentrations (over 1000 pCi/L), even a small fraction can be significant, and you can expect to see some lingering radon after purging the instrument.

The best solution is to purge for 10 minutes every few hours until the count rate goes down. Even in the worst possible case, the radon must decay with a 3.82 day half-life, so you will eventually be able to use the instrument again.

3.11.3 Intrinsic Background

Due to very low concentrations of alpha emitting contaminants in the materials of the RAD7's construction, you can expect to get as much as one count every two hours (0.009 cpm) without any radon present. This count rate, corresponding to about 0.02 pCi/L, is low enough to neglect when doing routine indoor radon work. But for very low-leveled outdoor radon levels, or special clean room applications, this background may be significant. With painstaking technique, and long-term monitoring, it can be measured. Very low level readings can then be corrected for background, bringing the detection threshold of the instrument down below 0.02 pCi/L.

3.11.4 Long-lived Radon Daughters

After many years of use at elevated radon levels, your RAD7's detector will accumulate lead-210, an isotope with a 22-year half-life. Though Lead-210 is itself a beta emitter, one of its daughters is polonium-210, which produces a 5.3 MeV alpha particle. The RAD7 is able to distinguish this isotope by its energy, and exclude it from all calculations. We do not expect lead-210 buildup to contribute significantly to background in the RAD7, even after years of use.

3.11.5 Contamination by Radon, or Thoron, Producing Solids

If radon- or thoron-producing solids, such as radium-226 or thorium-228, become trapped in inlet hoses or filters, they may emanate radon or thoron gas that will be carried through the filters and into the instrument. Certain dusty soils may contain enough of these isotopes to make this scenario possible. If you suspect this kind of contamination, please call DURRIDGE. We would like to discuss your experience with you and help you solve your problem.

3.11.6 Other Alpha Emitters

As long as you filter the incoming air stream, there is little or no possibility for contamination of the instrument with other alpha emitters. Virtually all solids will be stopped by the inlet filters. The only naturally-occurring alpha-emitting gas other than radon and thoron is radon-219, or "actinon."

Actinon, which has a very short half-life (less than four seconds), results from the decay of naturally-occurring uranium-235. But since uranium-235 is so much less abundant than uranium-238 (the ancestor of radon-222), we do not expect to ever see actinon in significant quantities apart from even more significant quantities of radon.

3.11.7 Beta and Gamma Emitters

The RAD7's solid state alpha particle detector is almost completely insensitive to beta or gamma radiation, so there will be no interference from beta-emitting gases or from gamma radiation fields. The most likely effect of high levels of beta or gamma radiation will probably be an increase in detector leakage current and increased alpha peak width. Typical environmental levels of beta and gamma emitters have absolutely no effect on the RAD7.

3.12 Precision & Accuracy

3.12.1 Dry operation

"Precision" means exactness of measurement with regard to reliability, consistency and repeatability. "Accuracy" means exactness of measurement with regard to conformity to a measurement standard. An accurate instrument is necessarily precise, but a precise instrument can be inaccurate (due to mis-calibration, for example).

As long as the operator follows consistent procedures, counting statistics will dominate the RAD7's precision. Environmental factors have proven to be much less significant over normal ranges of operation. Aside from precision, the most important factor in RAD7 accuracy is calibration.

DURRIDGE calibrates all instruments to a set of four "master" instrument with a calibration precision of about 1%. The master instruments have been calibrated by way of inter-comparison with secondary standard radon chambers designed by the U.S. EPA. We estimate the accuracy of the master instrument to be within 4%, based on inter-comparison results. We estimate the overall calibration accuracy of your RAD7 to be better than 5%. We look forward to new developments in calibration standardization and traceability, which we expect will help improve calibration accuracy.

The table on the following page summarizes the precision of the RAD7 according to the contribution of counting statistics. Counting statistics depend on sensitivity (calibration factor) and background count rate. The RAD7's intrinsic, or "fixed," background count rate is so low as to be a negligible contributor to precision, for the range of radon concentrations covered by the table. Environmental and other factors may affect precision by as much as 2%. The uncertainty values reported by the RAD7 are estimates of precision based on counting statistics alone, and are two-sigma values, as are the values in the table on the following page.

Table: 3.12 Typical RAD7 precision based on counting statistics only.

NORMAL mode with sensitivity 0.500 cpm/(pCi/L). Table values are two-sigma uncertainty (or 95% confidence interval) in units of pCi/L (percent).

	1 pCi/L	4 pCi/L	20 pCi/L	100 pCi/L
1 hr	0.37 (37%)	0.73 (18%)	1.64 (8.2%)	3.65 (3.7%)
2 hr	0.26 (26%)	0.52 (13%)	1.15 (5.8%)	2.58 (2.6%)
6 hr	0.15 (15%)	0.30 (7.4%)	0.67 (3.4%)	1.49 (1.5%)
24 hr	0.07 (7.4%)	0.15 (3.8%)	0.33 (1.7%)	0.74 (0.7%)
48 hr	0.05 (5.3%)	0.10 (2.6%)	0.23 (1.2%)	0.53 (0.5%)
72 hr	0.04 (4.3%)	0.09 (2.1%)	0.19 (1.0%)	0.43 (0.4%)

3.12.2 Humidity Correction

Much of the superior functionality of the RAD7 is a result of the high-precision real-time spectral analysis it performs. The high resolution of the energy spectrum is obtained by precipitating the radon daughters, formed by the decay of radon, right onto the active surface of the alpha detector. The high sensitivity of the RAD7 is a result of the large collecting volume of the measurement chamber. The combination of a precipitation process and large collecting volume means that humidity inside the measurement chamber will affect the sensitivity of the instrument. The effect is a function of the absolute humidity; specifically, ions in the presence of water vapor will attract water molecules, as they are polar, until a cluster of 6 - 10 water molecules gathers around each of them. These cluster molecules move more slowly in the electrostatic field and thus there is more time for the 218-Po atoms to become neutralized en route to the detector surface, and therefore lost. So with high humidity the sensitivity of the instrument drops. In addition the high voltage (2,200V) that maintains the electrostatic field is from a high impedance source. Excessive humidity inside the chamber makes it more difficult to maintain the high insulation resistance necessary.

At normal room temperature and with good desiccant in the air sample path, the humidity in the measurement chamber at the start of a measurement will quickly be brought down below 10% RH and will eventually settle below 6%. In these conditions the collection has maximum efficiency and there is no humidity correction

required. Should the desiccant expire and/or should the operating temperature rise well above normal room temperature, the absolute humidity may become significant and a humidity correction may be required to compensate for the drop in sensitivity.

While high humidity reduces the sensitivity of a RAD7, CAPTURE offers an automatic correction of the data, bringing readings back close to dry values. Please note, however, that the precision will be degraded, compared with readings taken in dry conditions. See Chapter 6.

3.12.3 Concentration Uncertainties

Obtaining accurate readings of a low radon concentrations often requires long cycle times, because when there are zero or very few counts within a given timeframe, the statistical uncertainty is proportionately high. Radioactive decays obey Poisson statistics, where the standard deviation (one-sigma) is the square root of the count. However, at very low counts Poisson statistics underestimates the uncertainty. To compensate, the RAD7 defines sigma as $1 + \text{SQR}(N+1)$, where N is the number of counts. Thus when there are no counts, instead of reporting a nonsensical zero uncertainty, the RAD7 reports an uncertainty value based on a two-sigma, 95% confidence interval, equivalent to +/- 4 counts for a cycle in which zero counts were recorded.

Typically, an average count rate of 0.2 cpm (i.e. one count in five minutes) would indicate a radon concentration of about 36 Bq/m³, but sigma would

be $1 + \sqrt{N + 1}$ or 2.4 counts, and the reported two-sigma value would be 4.8 counts. Thus after 5 minutes, the uncertainty would be reported as 0.96 cpm, or +/- 173 Bq/m³.

Large uncertainty values are often the product of the fact that it is impossible to measure low radon concentrations quickly. Greater certainty can be achieved by increasing the cycle time and/or by averaging multiple cycles. In Sniff mode, 218-Po (which has a 3.05 min half life) takes more than 10 minutes to reach equilibrium with the radon concentration in the RAD7 chamber. Note that in Sniff protocol, which uses 5-minute cycles, it is important not possible to start averaging the readings to reduce uncertainty only after the first two cycles.

It is possible to measure radon and thoron concentrations simultaneously, but since their requirements are sufficiently different, it may be desirable to optimize the measurement first for one gas and then for the other.

For radon, it is advisable to select SNIFF protocol and then change the cycle time to 10 minutes. After starting a run, the first reading can be ignored, with only the second and subsequent readings being used. As more readings are recorded, more precise concentrations will be obtainable.

Occasionally, a concentration uncertainty greater than the base value may be reported, e.g. 0.00 +/- 83.1 Bq/m³. Such values are typical for cycles containing zero counts. This should not be taken to suggest that a negative concentration may have occurred. The RAD7 does not report different positive and negative uncertainties, and it is expected that the user will recognize that the negative uncertainty can never be greater than the base value of the reading.

3.13 Spectrum Examples

3.13.1 Operational Radon Spectra

A. Idealized radon in equilibrium

This is what you would see if both the detector and electronics reached theoretical perfection. At full equilibrium, both peaks are at the same height.

A 6.00 MeV Po218
C 7.69 MeV Po214

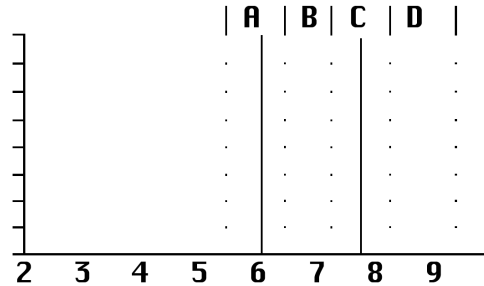

B. Radon in full equilibrium

After more than three hours at a constant radon level. The count rate in window C is about the same as in window A.

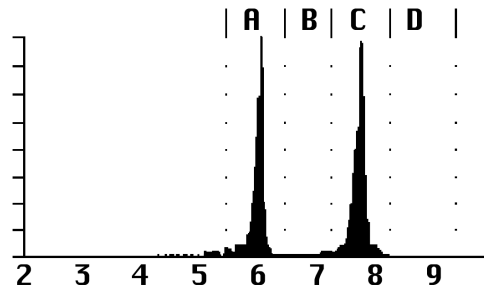

C. New radon

The RAD7 spectrum after less than one hour of exposure to radon. The peak in window C is just beginning to grow in, but its count rate is still much less than in window A.

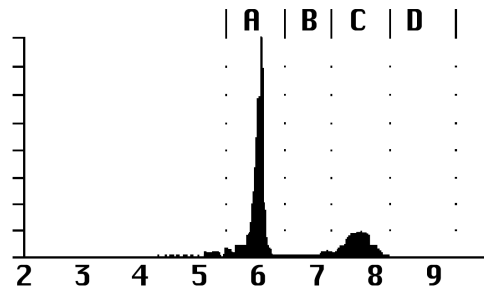

D. Old radon

The RAD7 spectrum after purging the instrument with radon-free air for more than 10 minutes, following exposure to radon.

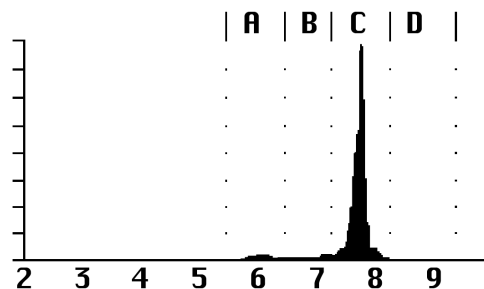

3.13.2 Thoron Spectra

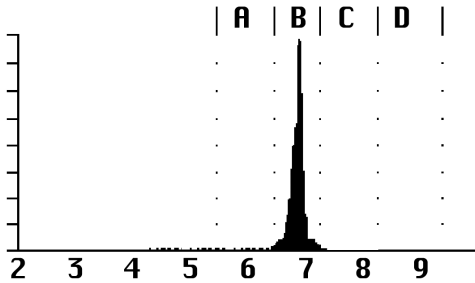

A. New thoron

The RAD7 spectrum while continuously sampling thoron laden air

B 6.78 MeV Po216

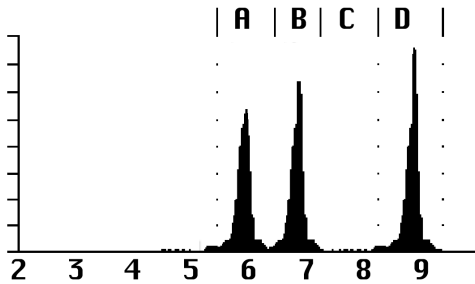

B. Thoron in equilibrium

The spectrum after continuously sampling thoron laden air for more than 12 hours. The count rate in window A should be about half the count rate in window D

A 6.05 MeV Bi212

B 6.78 MeV Po216

D 8.78 MeV Po212

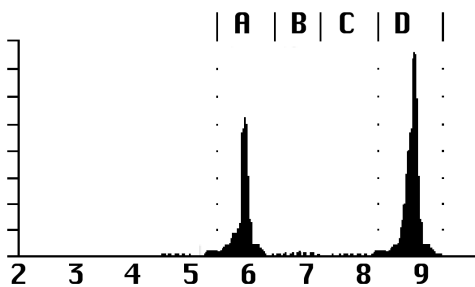

C. Old thoron

The spectrum after discontinuing a lengthy sampling of thoron laden air. The thoron peak, B, disappears immediately. The remaining two peaks decay together with a 10.6 hour half-life. The count rate in window A should be about half the count rate in window D.

3.13.3 Combination Spectra

Radon and thoron spectra can add together to form combination spectra. Peaks in window B and/or D come from thoron, while a peak in window C comes from radon. The peak in window A is usually entirely from radon, but if there is a peak in window D, then there will be a contribution of about half the D count rate to the peak in window A.

The RAD7 takes this into account, and always adjusts the window A count rate to correct for the Bi212 count, before calculating the radon concentration. The spectra below have comparable amounts of radon and thoron, but you will usually see one of the two much stronger than the other.

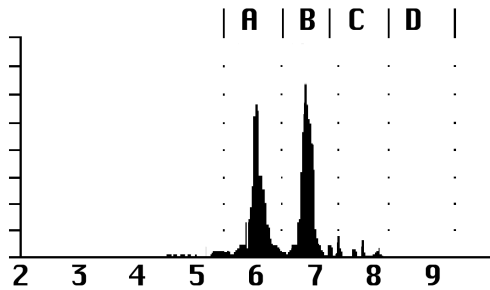

A. New radon with new thoron.

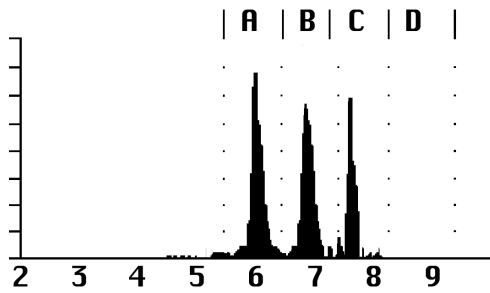

B. Equilibrium radon with new thoron

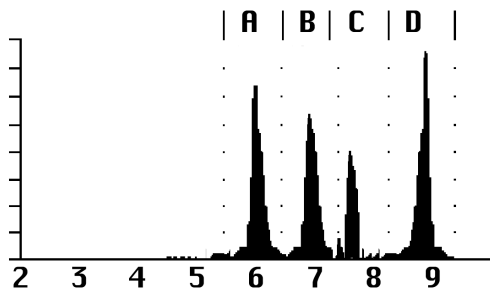

C. Equilibrium radon with equilibrium thoron.

The count rate in window A is roughly the rate of window C plus half the rate of window D.

A	6.00 MeV	Po218
	+6.05 MeV	Bi212
B	6.78 MeV	Po216
C	7.69 MeV	Po214
D	8.78 MeV	Po212

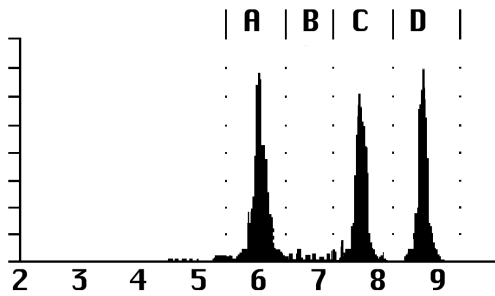

D. Equilibrium radon with old thoron

The count rate of A is roughly the rate of window C plus half the rate of window D.

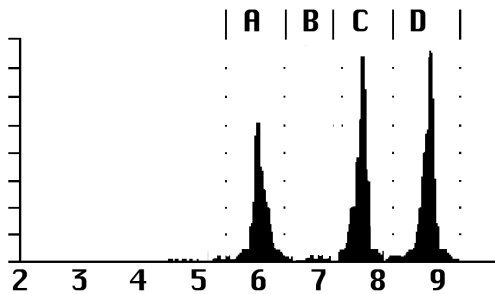

E. Old radon with old thoron.

The count rate in window A is no more than about half the count rate of window D.

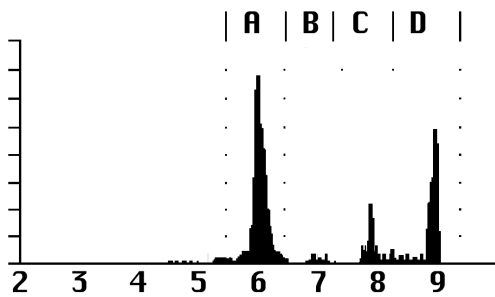

F. New radon with old thoron.

Looks like an old thoron spectrum, but the count rate of window A is significantly more than half the count rate of window D.

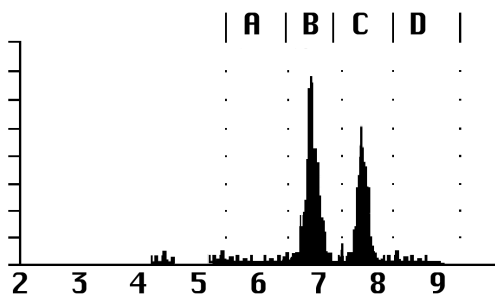

G. New thoron with old radon.

3.13.4 Pathological Spectra

If any of the following occur, and an external cause is not identified, the user should contact DURRIDGE immediately.

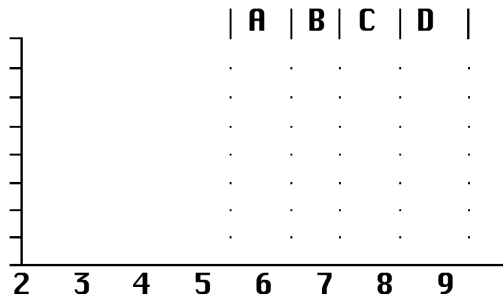

A. No counts.

Try a longer counting time. If there is not a single count in an hour, that is clear indication of instrument malfunction.

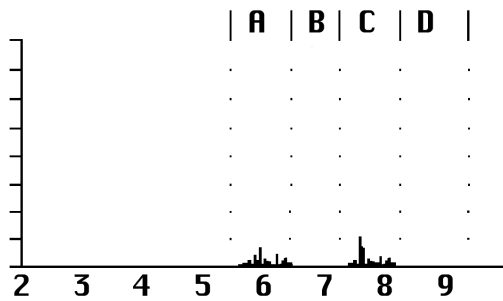

B. Few counts.

Normal for low radon levels and short counting times. Abnormally low counts could be caused by disruption of the air flow, or by malfunction in the high voltage circuit.

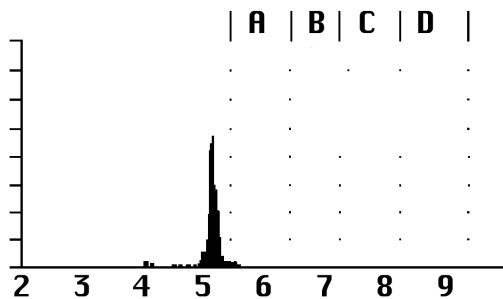

C. Lead-210/polonium-210.

A persistent peak at 5.3 MeV will develop from many years of regular use, or from sustained exposure to very high radon levels. It results from the buildup of lead-210 on the detector surface. Lead-210 has a 22 year half-life. It is not a problem for the RAD7 because the peak is outside window A, and thus does not contribute to the background.

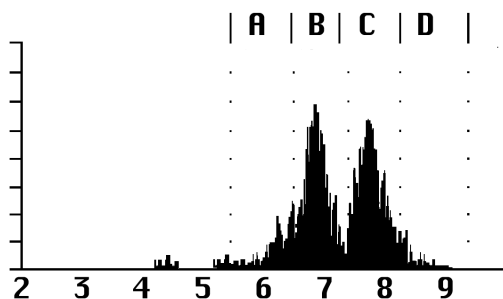

D. Wide alpha peaks.

Typically caused by electronic noise in the system. May be associated with vibration, with high operating temperature, or with degradation of the surface barrier detectors used in older model RAD7's, built prior to 1996.

E. Smear spectrum.

Alpha peaks cannot be discerned by the eye.
Severe electronic noise.

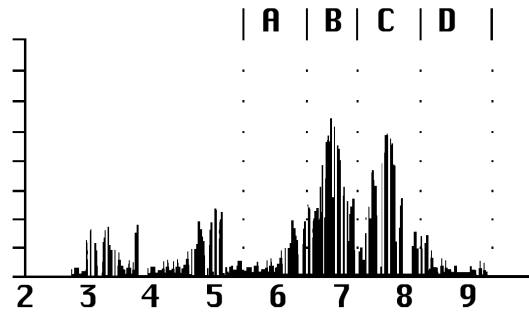

F. Low energy noise.

Independent of radon or thoron, such
electronic noise may be intermittent or be
associated with vibration.

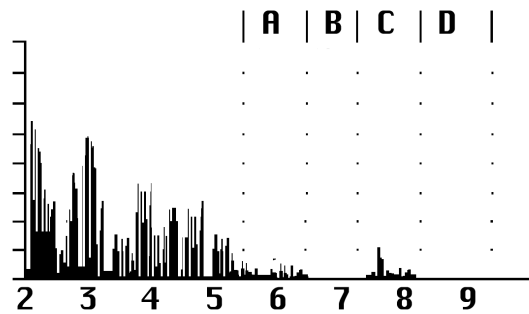

G. Shifted peaks.

Peaks appear normal, but are shifted in
position. Shows a malfunction of the RAD7,
which should be returned to DURRIDGE for
service without delay.

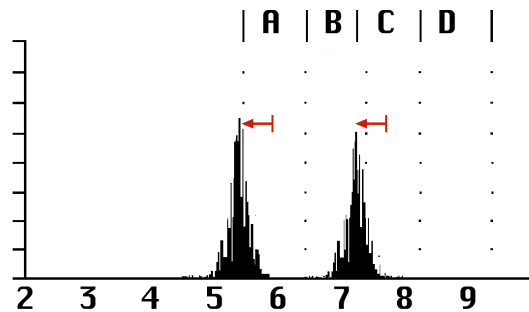

H. Heavy tails on alpha peaks.

The peaks are narrow, but have unusually thick
tails. This may be caused by electronic noise,
or by malfunction of the alpha detector.

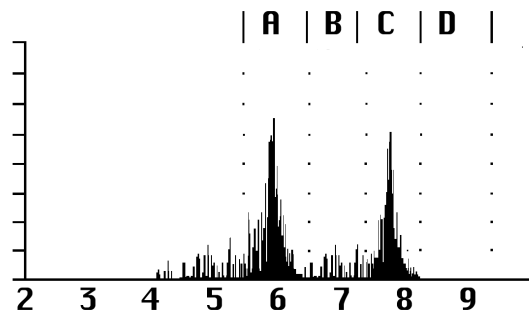

4 USING THE RAD7: MEASURING RADON AND THORON IN AIR

4.1 Introduction

The different ways of using the RAD7 may be arranged in six categories:

- (a) continuous monitoring of radon in air
- (b) sniffing for radon and/or thoron
- (c) testing air grab samples
- (d) measuring radon in water
- (e) testing soil gas
- (f) measuring radon and thoron emissions from objects and surfaces.

While all six are discussed below, it is primarily categories (a) and (d) that require standard operating procedures. The other applications tend to be more interactive, and individuals will develop protocols which work best for them. This chapter focuses on using the RAD7 to measure radon and thoron in air, without the user of special hardware accessories. Chapter 5 introduces applications involving the optional RAD AQUA, RAD H₂O, and other DURRIDGE accessories.

4.2 Continuous Monitoring

4.2.1 Preparation

The RAD7 batteries should be fully charged so that, even if there is a power cut, the test will be completed. Similarly, there should be more than sufficient active desiccant in the Laboratory Drying Unit.

For an EPA protocol test, the house should be fully closed from 12 hours before the start of the test. This means that ALL doors and windows should be shut tight. No air exchange system, or ventilation fans, may be running.

In winter it is not difficult to satisfy this requirement. Continued operation of the furnace is permitted. Closed house conditions are usually maintained anyway, to save heating costs. Doors may be opened momentarily, for access, but should otherwise remain closed during the test.

In summer it may be impossible to satisfy the requirement, without the residents moving out for the duration of the test. If doors and windows are left open, it can nullify the test, except that if there is a radon problem under these conditions, then there will be a greater problem under closed house conditions.

Air conditioning often includes some fresh air ventilation, which dilutes the radon. Even if there is no ventilation, the cold air in the house will want to sink, increasing pressure in the basement, and thus reducing any flow of soil gas into the house. So air conditioning in the summer will tend to lower the radon level in the house.

For further detailed information, see the EPA “Indoor Radon and Radon Decay Product Measurement Device Protocols” publication, EPA 402-R-92-004, or view it at <http://www.epa.gov/radon/pubs/devprot1.html>

4.2.2 Purging

For the RAD7 to be all set to go, ready to start a test, it should be purged for at least five minutes beforehand. This may be done in the car, en route to the test site.

Locate an inlet filter, a piece of tubing with a sleeve at one end and small tube at the other, and the laboratory drying unit. Connect the filter to the tubing: It should be a tight fit into the small diameter section. Remove the plastic caps from the drying unit and push the sleeved end of the tubing onto the tube connector, on the drying unit, farthest from the metal screw cap. Now attach the filter to the inlet of the RAD7.

Switch on the RAD7, push [MENU], [ENTER], [→] four times, to see >Test Purge on the display, then push [ENTER]. The pump will start. The display will show Stop purge? No. Leave the unit purging for five minutes, or longer. When you are ready to start the test, the easiest way to stop purging is to push the Menu key, or switch off the instrument.

4.2.3 Test Location

In general, the test should be conducted in the “lowest area in the house that is used, or could be adapted for use, as a living area”. This would include a full-height basement, but not a crawl space.

Place the RAD7 near the center of the room, about 3 - 4 feet above the floor. Avoid walls, vents, fireplaces, windows, draft, and direct sunlight.

Where possible, connect DC power to the RAD7, to conserve and recharge the batteries.

The air intake will be the connector of the drying unit without any tubing attached (nearest the end with the metal screw cap), or the far end of the tube if one is attached to this connector. Make sure the air intake is at least 30 inches (75 cm) above the floor, and away from the walls.

Once set up in location, let the RAD7 continue to purge until ready to start the test.

4.2.4 Test Protocol

In any location there is often a diurnal variation of radon level. It is preferable, therefore, that the test period be an exact number of whole days. The EPA protocols require an average taken over at least two days. The RAD7 gives time resolution as well. A choice must be made, therefore, of the cycle time and the number of cycles (recycle). For 24-hour and 48-hour tests, the RAD7 has preset protocols which will make the choice for you. You can always change the choices (even in the middle of a test!), and, if you wish, save your preferences as the user protocol. You may, for instance, prefer to conduct 3-day tests, and, perhaps, use 24 cycles, each 3 hours long. The longer the test, the greater the precision of the result.

For a 24-hour or 48-hour test, using the preset protocol, before starting the test, go to **>Setup Protocol** and choose **1-day** or **2-day**, and then push **[ENTER]**. You need, also, to decide whether to leave the tone **Off**, **Chime**, or **Geiger**, and whether to have short, medium or long format of printouts at the end of each cycle, and set the parameters accordingly.

For very long term monitoring, use the **Weeks** protocol. This sets the RAD7 to run indefinitely, with 2-hour cycles. The internal memory capacity, of 1,000 cycles, will last nearly 12 weeks. If data is periodically downloaded to a PC, and erased from the RAD7, there is no limit to the measurement duration. With the laboratory drying unit used to dry the sampled air, the desiccant will have to be replaced every 7 to 14 days, depending on the humidity. The RAD7 needs external power for indefinite operation, but can survive, without loss of data, an interruption of power lasting up to 50 hours, or more, depending on the condition of the batteries.

For any other measurement period, you will need to set the parameters yourself. The cycle time, times the number of recycles, gives the duration of the total measurement. In almost every case, for continuous monitoring, choose **[Mode Auto]**, **[Thoron Off]**, and **[Pump Auto]**.

Once the RAD7 switches (after three hours) to **NORMAL** mode, the counts are included from **Window C**, which come from **Po-214** atoms. These were once radon atoms, that entered the measurement chamber as much as an hour or more beforehand. Therefore, in **NORMAL** mode, the RAD7 is averaging the radon concentration from less than 20 minutes ago (**Po-218**) with the radon concentration from less than three hours ago (**Po-214**). So, for a long test in **NORMAL** mode, the cycle time should be set to one hour, or more.

Where there is a requirement for a fast response and detailed time resolution, the cycle time may be set as short as half an hour, or even 20 minutes, but the **Mode** should then be set to **Sniff**, not **Auto**. Note however, that counting only **Window A**, and for such short periods, the number of counts per cycle will be less than for longer cycles in **NORMAL** mode, and so the individual readings will have more scatter. Note also that short cycle times will fill up the memory more quickly (the capacity is 1,000 cycles), use up the desiccant more quickly, and, if the printer is being used, produce more printout.

4.2.5 To Print Or Not To Print

It is not necessary to run the printer during a measurement as all data, except for the detailed spectra, are stored at the end of every cycle, and are available for printing or downloading to a PC at any time. Furthermore, with no printer and the keypad locked, it is impossible for any unauthorized snooper to read the radon concentration during the run. On the other hand, use of the printer gives a convenient and informative hard copy of the results. For routine continuous monitoring, it is usual to set the printer format to short (Setup, Format, Short, [ENTER]).

Place the printer on the face plate and switch on. Switch the RAD7 off, then on again. Information about the RAD7, and the setup, will print out. Data will be printed at the end of every cycle, and a summary, bar chart and cumulative spectrum will print at the end of the run.

4.2.6 Running the Test

When everything is ready, start the test (Test, Start, [ENTER]). The pump will start running and the LCD display will go to the first status window.

The house should remain in closed condition for the duration of the run. At any time, the status windows can be viewed. The relative humidity, temperature and battery voltage are all parameters that are worth observing. Rising relative humidity may indicate that the desiccant is exhausted, or that there is a leak in the sample path. The temperature reading gives a base for future reference, see below. A dropping battery voltage may indicate that the power is not connected.

4.2.7 Security and Quality Control

For a good measurement, it is essential that the RAD7 (or any measurement device, for that matter) remain in its place, and the house remain closed, throughout the run.

Anti-tampering tapes are available for the windows and doors. A soft, plastic adhesive, such as Blue-Tack, HOLDIT or Tac'N Stik, under the RAD7, will stick better the first time than in

subsequent placings. An experienced hand can tell if the RAD7 has been moved. But perhaps the best anti-tampering defense is the data itself. With the time resolution in the data provided by the RAD7, anomalies are clearly revealed. A sudden change in radon concentration and in air temperature, during the measurement, is a strong indication of tampering, either by moving the instrument, or by opening windows. The RAD7's keypad lock feature prevents tamperers from looking at the data, or interfering with the measurement. (See Section 2.2.6, Test Lock.)

A detailed and systematic quality control protocol must be established by any user seeking certification. This should include a description of the measurement process, and the steps taken to ensure that the readings are reproducible.

The RAD7 is too accurate for any procedure in the field to be able to verify that it is working within specifications. However it is a good practice to compare the RAD7 readings with some other device, such as a passive charcoal collector. The two devices should be placed close together, with the RAD7 sampling point near to, but not touching, the charcoal collector. The tests should occur during the same time period. The charcoal reading may then be compared with the RAD7 mean for the period. Remember, however, that some charcoal devices, and labs, may give readings which are in error by as much as 25%. If the RAD7 and the charcoal device differ by more than 10%, repeat the comparison as soon as possible, preferably with a different charcoal device, from a different lab. Look at the RAD7 cumulative spectrum, printed out at the end of a run, to see if it appears normal. If the RAD7 mean is consistently, significantly different from the readings of other devices in side-by-side tests, or if the spectrum looks abnormal, please call, or email, DURRIDGE for advice. In any case, we recommend that the RAD7 be returned to DURRIDGE Company, for recalibration, annually.

An excellent test of RAD7 quality is to examine the cumulative spectrum printed at the end of every run. If the spectrum looks normal, and the humidity, temperature, and battery voltage are acceptable, the RAD7 is most likely fine.

4.2.8 Finishing the Run

Even if no printout has been made at the end of every cycle, it is still useful to have a printout at the end of the run. If the RAD7 can be accessed before the run is finished, simply place the printer in position on the face plate and switch it on. After the last cycle is completed, the RAD7 will print the run summary, including the mean value, the bar chart of all the readings, and the cumulative spectrum. If the instrument cannot be accessed before the end of the run, the summary can be printed out later, but without the cumulative spectrum.

Switch off the printer and the RAD7. Disconnect the tubing from the desiccant and replace the plastic caps over the hose connectors. If the caps have been lost, a single piece of tubing may be attached between the two connectors, thus providing a seal to keep the desiccant dry.

Remove the inlet filter from the RAD7. It is good practice to leave the inlet filter attached to the plastic tubing. Replace the short piece of tubing connecting the inlet to the outlet. Putting the jumper between the inlet and outlet keeps the internal space of the instrument sealed and thus dry, while still allowing air flow should the pump start running.

When moving the RAD7, please treat it with respect. It is rugged, but it is still an electronic instrument. Please avoid hard knocks and very harsh environments.

4.2.9 Examining the Data

In addition to the printout, data may be examined on the LCD, during or after a run. The records may also be downloaded to a PC, where they are then available for creating graphs and tables for printed reports.

On reviewing a set of data, first check that the relative humidity in the instrument stayed below 10% throughout the measurement. If it rose above 10%, it suggests that the desiccant was either removed, or became depleted. The RAD7 reads low if the internal RH rises above 10%. The temperature during the measurement should remain fairly steady. Sudden changes of

temperature in the record suggest that either the windows were opened, or the RAD7 was moved to a different location.

If the house was not properly closed up until the measurement was started, you may expect to see a rising radon concentration during the first few hours of the run. If that is the case, any very low, early readings should be discarded in the calculation of the mean value for the house. That would mean manual calculation of the average, from the good readings. EPA protocols require at least 48 hours of continuous good data. If the house was not closed up beforehand, a 3-day test could satisfy the EPA requirement.

If the air sampling point was changed for a while, or some windows opened, during the run, you may expect to see a change in air temperature, and change in radon concentration, during that period. Simultaneous changes of these two parameters is an indicator of tampering.

4.2.10 Very Short Term Monitoring

Some home inspectors choose to use the RAD7 for a short-term test, just during the home inspection. This means that they have full control over the test, and they can take the RAD7 with them, when they leave, on completion of the home inspection.

They close up the house, set up the RAD7 in the basement, choose a half-hour cycle time and a total run length (recycles) of, typically, four or five cycles. At the end of the run, the RAD7 prints out a bar chart of the increasing radon concentration, at half-hour intervals. The data gives the Home Inspector, and his client, a good indication of the radon situation. Adding 50% to the final half-hour reading gives an estimate of what would be the average radon level, for closed house conditions. If, during those two hours of the test, the radon concentration climbs towards, or over, the 4 pCi/L mark, then they can be confident that, with a full 2-day EPA protocol test the result would surely exceed the 4 pCi/L action level.

4.3 Sniffing

4.3.1 Why Sniff?

There are two main reasons for sniffing. One is to obtain a quick, spot reading of radon concentration, as a simpler substitute for grab sampling, and the other is to locate radon entry points. For each application, the method will be slightly different.

4.3.2 Locating Radon Entry Points

There is a very good chance that thoron will be present in the soil gas entering the building. It will, however, be detectable only close to the entry points. Thoron, therefore, if it is in the soil gas, can be considered as a tracer for fresh radon gas. Sniffing to locate radon entry points may, therefore, be focused on detecting thoron, if it is there, to speed, and simplify, the process. The same procedure will also give radon concentrations, provided that the sampling point is kept at one spot for at least 15 minutes.

4.3.3 Preparation

Detailed instructions are given in Chapter 1.5. Choose Thoron in the Setup Protocol menu, and set the Tone to Geiger. Employ a small drying tube and, preferably, just a yard of tubing to the inlet filter.

4.3.4 Purging

While it is always good practice to purge the instrument before using it, there is less necessity before sniffing. In SNIFF protocol, the pump runs continuously, so the air sample will be flushed through every minute or two, and the measurement chamber will quickly dry out, even if the relative humidity starts above 10%.

To bring the humidity in the instrument down without wasting desiccant, the RAD7 outlet may be connected to the open end of the drying tube, making a closed loop, during the purge cycle.

After detecting high concentrations of radon and/or thoron, it is good practice to purge the instrument immediately after use.

4.3.5 Running the Test

With the RAD7 strap over one shoulder, holding the small drying tube as a wand, start the test. The first status window will be displayed in the LCD. Push the right arrow five times, to reach the B window status screen. This will show the cpm for thoron. You may also listen to the beeps, which have a different pitch for different windows. Thoron has a high-pitched beep.

Floor/wall, wall/wall and split-level seams are common locations for radon entry points. So are sumps, wells, beam pockets and utility conduits, entering the building from below ground level. It is useful, before starting the sweep, to have a sketch map of the area, with the likely culprits marked, on which to write down the readings. While making this sketch map, the RAD7 can be taking a benchmark radon measurement in the center of the room. Take at least four 5-minute-cycle readings. Later radon readings, at likely entry points, can then be compared with this benchmark.

To start the sweep, hold the small drying tube as a wand, with the open end either in, or as close as possible to, the most likely radon entry point. Keep it there for at least five minutes. If the thoron count, in window B, during this time, exceeds 2 cpm, say, then you know a) that you were right in your suspicion, and that you are, indeed, close to a radon entry point, and b) that thoron is present in the soil gas, so you can concentrate on thoron for the rest of the survey. Move the wand a foot or so in any direction to see if the window B cpm changes appreciably, in the next cycle.

If there are few or no counts in window B, then either the location is not a radon entry point, or there is no appreciable thoron in the soil gas. You must, then, keep the wand in that position for another 10 minutes, or until the counts in window A start to rise rapidly. If, after fifteen minutes, there are still only a few counts in window A, and the radon concentration, displayed at the end of the third 5-minute cycle, is still very low, then you can be confident that the position is not a radon

entry point. On the other hand, a high radon concentration, without thoron, does not necessarily indicate a radon entry point if the whole basement is high. In either case, you need to note the reading on your sketch map, and move to another likely point to repeat the process, first looking for thoron.

If no thoron is found at any time, then the map of radon concentrations, will help to identify entry points. Once thoron has been detected, the whole search is made much easier. Reset the cycle time to two minutes. Spend one complete cycle at each suspected radon entry point, observing the counts in window B, or listening for the characteristic thoron beeps. You will quickly determine the location and relative strengths of the radon entry points, from the cpm in window B, for the different locations. Note that, in this procedure, you must ignore the counts in window A, because they refer to radon that entered the measurement chamber as much as 10 minutes previous to the observed counts.

Even if thoron is present at some points, there is still a possibility that there may be a radon entry point showing little or no thoron. This could occur if the path taken by the soil gas was very long, or the flow was slow. Conduit for a utility service, or a path up a hidden shaft in a wall, could delay the entry of the soil gas by several minutes. Each minute's delay halves the concentration of thoron.

4.3.6 Drilled Sampling Points

Some mitigators drill a number of test holes through the concrete slab, to sniff the soil gas beneath and to test the communication between different areas of the slab. They then install the suction points of the mitigation system where the sub-slab radon readings are highest. This approach is complementary to the search for actual radon entry points, as described above. Both methods are likely to result in a similar, final configuration of the mitigation system, though locating the entry points can also indicate where additional sealing is required.

4.3.7 Spot Readings

A spot reading may be accepted only as a rough indicator of the radon level at any location. This is not only because a short-term reading is less precise, but also because it does not average out the fluctuations in radon level through a typical day. The EPA protocol calls for a measurement to cover at least two days. Quite often, the indoor radon concentration tends to be higher in the early morning, after a cold night, and lower at the end of a warm day.

Furthermore, the radon concentration, typically, takes hours to recover from open doors and windows so, unless the house was closed up tight for many hours beforehand, the spot-reading radon level will be significantly lower than an average, taken over several days, in closed house conditions.

For this spot reading, the sampling point should be away from walls and floor. Thoron is not an issue in this measurement, so the larger, laboratory drying unit may be used, instead of a small drying tube. The cycle time may be left at five minutes. At least four, better six, cycles should be taken, of which the first two should be ignored. Alternatively, increase the cycle time to 10 minutes, or more, and ignore the first reading.

To measure a radon level of 4 pCi/L, with a standard deviation of no more than 10%, needs a run of one hour (six cycles of ten minutes, say).

4.4 Grab Sampling

4.4.1 Applicability

The ability of the RAD7 to “grab” a collected sample is useful when it is not possible to take the RAD7 to the location to be tested, or when the RAD7 is pre-occupied with continuous monitoring and will not be available until later. The Grab functionality is also useful when many samples must be gathered from different rooms of a building within a short timeframe.

However, if the RAD7 is available and can be taken to the test location, then data quality is much improved by a) monitoring the radon level over an extended period of time, such as 1-day, or, if that is not a possibility, b) making a short-term

measurement such as described in Chapter 4.2.10, or else just sniffing for a spot reading, as described above.

Grab samples have the same shortcomings as spot readings. The radon concentration 'grabbed' is not representative of the EPA average level at the sampling location. The precision of the reading is also limited by the short time for counting.

4.4.2 Preparation

It is important that the RAD7 be well dried out prior to accepting the grab sample. First, purge the unit with fresh, dry air for five minutes. Then connect the laboratory drying unit in a closed loop with the RAD7 so that air from the outlet passes through the desiccant and back into the inlet. Note that air should always flow the same way through the desiccant. Purge for ten minutes then check the relative humidity (push [MENU] [ENTER] [ENTER], then [→] [→]). If the RH is not below 8%, repeat the process. Keep the pump running until ready to take the grab sample.

4.4.3 Protocol

Choose the Setup, Protocol, Grab menu selection, and push [ENTER]. This will set up all the measurement parameters correctly. For the printout, choose Setup, Format, Short.

4.4.4 Taking the Sample

If the RAD7 is at the location, simply start the test ([MENU] [ENTER] [→] [ENTER]). Alternatively, samples may be taken in tedlar air sampling bags. Samples of at least five liters are required.. Any sampling pump may be used. Even the RAD7 could be used as a sampling pump, but remember to purge the instrument of old air first. These bagged samples may be connected to the RAD7 and analyzed later. Make sure there is active desiccant and the inlet filter in place, between the sample bag and the RAD7.

4.4.5 Analysis

With the grab sample source connected to the RAD7, start the test ([MENU] [ENTER] [→])

[ENTER]). The pump will run for five minutes, flushing the measurement chamber, and then stop. The RAD7 will wait for five more minutes, and then count for four 5-minute cycles. At the end of the run, the RAD7 will print out a summary, including the average radon concentration, a bar chart of the four cycles counted, and a cumulative spectrum. The measurement process takes 30 minutes. If the analysis is made more than an hour after the sample was taken, a correction must be applied for the decay of radon in the sample.

4.5 Thoron Measurement

4.5.1 Thoron and Radon

Thoron is an isotope of the element radon having an atomic mass of 220, so it is also known as radon-220. The word "radon" without a mass number almost always refers to radon-222. Thoron and radon have very similar properties. They are both chemically inert radioactive gases that occur naturally from the decay of radioactive elements in soils and minerals. Both thoron and radon are members of decay chains, or long sequences of radioactive decay.

While radon results from the decay of natural uranium, thoron results from the decay of natural thorium. Both uranium and thorium are commonly found in soils and minerals, sometimes separately, sometimes together. The radioactive gases radon and thoron that are produced in these soils and minerals can diffuse out of the material and travel long distances before they themselves decay. Both radon and thoron decay into radioactive decay products, or progeny, of polonium, lead, and bismuth before finally reaching stable forms as lead.

Thoron and radon and their respective progeny differ very significantly in their half-lives and in the energies of their radiations. While radon has a half-life of nearly 4 days, thoron has a half-life of only 55 seconds. Since thoron is so short lived, it cannot travel as far from its source as radon can before it decays. It is commonly observed that compared to that of radon gas, a much smaller fraction of the thoron gas in soil ever reaches the interior of a building. Even so, thoron can still be a hazard since its progeny include lead-212 which

has a half-life of 10.6 hours, more than long enough to accumulate to significant levels in breathable air.

4.5.2 Thoron Measurement Issues

Many difficulties impede the accurate measurement of thoron gas. The presence of radon gas (often found together with thoron) can interfere with a measurement. The short half-life of thoron gas makes some aspects of the measurement easier, but makes sampling method a critical issue. Thoron concentration can vary greatly through a space, depending on the speed and direction of air movement as well as turbulence. The position of the sample intake can strongly affect the results.

In many instruments, radon and thoron interfere with each other. Generally speaking, it is difficult to measure one isotope accurately in the presence of the other. But compared to other instruments, the RAD7 is much less susceptible to radon-thoron interference due to its ability to distinguish the isotopes by their unique alpha particle energies. The RAD7 separates radon and thoron signals and counts the two isotopes at the same time with little interference from one to the other.

Some issues of concern in measuring radon do not apply to thoron. The short half-lives of thoron (55 seconds) and its first decay product (Po-216 - 0.15 seconds) mean that thoron measurements can be made quickly and in rapid succession, since there is little concern with growth and decay delays. The RAD7 responds virtually instantly to the presence of thoron; its time constant for response to thoron is less than 1 minute. The chief limit on the thoron response speed is the pump's ability to fill the internal cell. And the RAD7 clears just as rapidly when you purge the instrument with thoron-free air. In fact, you need not purge the instrument at all between thoron tests, because thoron's short half-life ensures that it will be gone in a few minutes.

In thoron measurement the sample pump must run in a continuous fashion, at a steady consistent flow rate. If the flow rate of the sampling pump changes, the RAD7 thoron result will also change. Flow rate affects the amount of thoron in the

internal cell, since a significant fraction of the thoron decays in the sample intake system as well as within the instrument.

The RAD7 measures thoron concentration in the air at the point of sample intake. Since thoron varies from place to place depending on the motion of the air, the instrument operator may find it necessary to make measurements in several locations to properly assess a thoron situation. Fortunately, rapid-fire thoron measurements are very easy to do with the RAD7.

4.5.3 Calculation and Interference Correction

The RAD7 calculates thoron concentration on the basis of the count rate in spectrum window B which is centered on the 6.78 MeV alpha line of Po-216, the first decay product of thoron gas. To further avoid interference from radon, the RAD7 applies a correction to the thoron count rate to compensate for a small percentage of "spillover" from window C.

If the spill from window C to window B is too great relative to the base amount in window B, it becomes impossible to calculate thoron concentrations with sufficient certainty. This situation can be avoided by purging the RAD7 with fresh air and waiting with the unit turned off for two hours prior to testing for thoron. This provides enough time for the peak in window C to decay to one tenth of its original value.

The RAD7 calculates radon concentration from the count rate in window A (SNIFF mode) or windows A plus C (NORMAL mode). The RAD7 compensates for interference from the long-lived progeny of thoron (10.6 hours) by applying a correction to the radon count rate in both SNIFF and NORMAL modes. The correction is based on a fixed fraction of the count rate in the D window (around the 8.78 MeV peak of Po-212) which predicts the amount of thoron progeny activity in the A window (due to the 6.05 and 6.09 MeV peaks of Bi-212). Note that the uncertainty figures given with each reading include the effect of these corrections.

4.5.4 Avoiding Longer Lived Decay Products

Although the RAD7 corrects for the buildup of the long-lived thoron progeny (10.6 hour), we recommend that you avoid unnecessary exposure of the instrument to high levels of thoron for long periods of time. The presence of these long-lived progeny can make low level radon measurements somewhat less accurate than would otherwise be possible. But if you err, the 10.6 hour half-life of the thoron progeny makes for a temporary inconvenience of a few days at worst.

4.5.5 Standard Thoron Setup, Thoron Calibration and Flow Rate

As discussed above, thoron's rapid decay causes the intake path and the air flow rate to become important factors in calibration. The RAD7 factory calibration for thoron is based on a standard RAD7 inlet filter, a standard 3-foot long, 3/16 inch inner diameter vinyl hose, and a standard small (6 inch) drying tube. Deviation from this arrangement can change your thoron results. For example, if you were to use a very long hose for thoron sampling, then the sample might decay significantly before it ever reached the instrument inlet. The same thing would happen if you substituted the small drying tube with the full-sized laboratory drying unit. In that case, the thoron reading should be multiplied by a factor of approximately 2.0. Additionally, if you were to use a non-recommended inlet filter, the flow might be restricted enough to greatly lower the result. For more details, see Section 4.5.9.

4.5.6 Calculating Sample Decay

The thoron concentration at the inlet of the RAD7, C1, can be expressed mathematically as

$$C1 = C0 * \exp(-L * V1 / q)$$

where C0 is the original sample concentration, V1 is the volume of the sample tube + drying tube + filter (around 50 mL), q is the flow rate (around 650 mL/min), and L is the decay constant for thoron (.756 /min). A typical value for C1/C0 is then

$$C1/C0 = \exp(-.756 * 50 / 650) = 0.943 = 94.3\%$$

This is the number DURRIDGE assumes in the factory calibration. Adding a few extra feet of hose will not matter much (about 0.5% per foot), but if we were to use a 100 foot hose instead (V1 is around 580 mL) then the same calculation would give 0.509 or 50.9%, a significant reduction from 94.3%!

4.5.7 Calculating Internal Cell Concentration

The sample decays slightly in going from the RAD7 inlet to the internal cell, due to internal hose and filter volumes. This decay can be calculated in a similar fashion to the above, giving the internal cell inlet concentration, C2, about 95.5% of C1. Within the RAD7 internal cell, the equilibrium thoron concentration, C3, will be determined by the following formula:

$$C3 = C2 / (1 + L * V2 / q)$$

where L and q are as above, and V2 is the volume of the internal cell (around 750 mL). Typical values then give C3/C2 as

$$C3/C2 = 1/(1+.756 * 750/650) = .534 = 53.4\%$$

Multiplying this result by the sample decay factors calculated above, we obtain an overall concentration in the internal cell of 48.1% of the original sample. Recognizing the uncertainty of several of the inputs to these formulas, particularly the flow rate, we will round the overall result to 50%.

4.5.8 Internal Cell Thoron Sensitivity Calibration

Preliminary investigations have shown that the RAD7's internal cell thoron sensitivity in cpm/(pCi/L) is identical to its radon SNIFF mode sensitivity, to within 25%. We have no reason to expect any sizable difference between the thoron and radon SNIFF mode sensitivity values, so we are presently assuming that the two values are indeed nearly equal, and claim an uncalibrated thoron precision of +/- 30%.

With calibration against a thoron standard assessed by gamma spectrometry we are able to state the thoron sensitivity with much higher certainty. This thoron calibration is offered as an

option and for this we claim an overall accuracy of +/- 20%. Otherwise we estimate the overall thoron sensitivity to be 50% of the radon Sniff sensitivity to account for sample decay in the intake and internal cell. The RAD7 has a typical radon Sniff sensitivity of 0.25 cpm/(pCi/L), so we estimate the typical thoron sensitivity to be around 0.125 cpm/(pCi/L).

4.5.9 Setting up a Thoron Measurement

For a quantitative measurement of thoron it is necessary to use the Standard Thoron Setup and protocol. The Standard Thoron Setup consists of a small drying tube, used as a wand for sniffing, with a standard input tubing of 36" (91.4cm) length and inner diameter (ID) of 3/16" (4.8mm); see the diagram on the following page.

The small drying tube should be positioned vertically and filled with fresh (blue) desiccant. Always use an inlet filter, free from flow restrictions or clogs. Avoid obstructing the intake of the sample tube.

Keep the RAD7 plugged in and its battery charged so that the battery voltage remains steady at close to 7V. This will ensure a high and consistent air flow rate, providing the optimal thoron sensitivity. For the most accurate results, check the flow rate with a meter (rotameter or "floating ball" type) to be sure it is consistent from measurement to measurement. (Note that the flow rate affects the thoron reading, but not radon due to its much longer half-life.)

Use the RAD7's Setup Protocol command to choose Thoron protocol for a 5 minute repeating

cycle. Before making a measurement, be sure the instrument has been "dried out", as described in Section 2.2.5. Position the sample tube intake and start the test.

For accurate thoron measurement, always use this sample taking arrangement.

The 216-Po daughter of thoron has only a 145 ms half life, so the main component in the response time of the RAD7 to a step change in thoron concentration is the time taken to acquire the sample. The response is virtually instantaneous.

Sniffing for thoron is much the same as sniffing for radon, except it tends to be a little faster. If you are just "prospecting", you probably will not be very interested in getting the most accurate results possible, so technique is not critical. But if you are trying to make an accurate measurement, technique is of great importance.

4.5.10 Thoron Mode

Thoron mode causes the RAD7 to print both thoron and radon concentrations (in pCi/L or Bq/m³) in continuous data logging or in subsequent printing of data. Thoron mode also directs the automatic pump setting to continuous pump operation to assure a fresh sample.

The setup parameter "Setup Thoron" allows you to select Thoron mode On/Off, for configuring a particular test to perform thoron readings.

The protocol "Protocol: Thoron" provides a standard test for sniffing both radon and thoron in 5 minute cycles. For more information on Protocols, see Section 2.4.1, Setup Protocol.

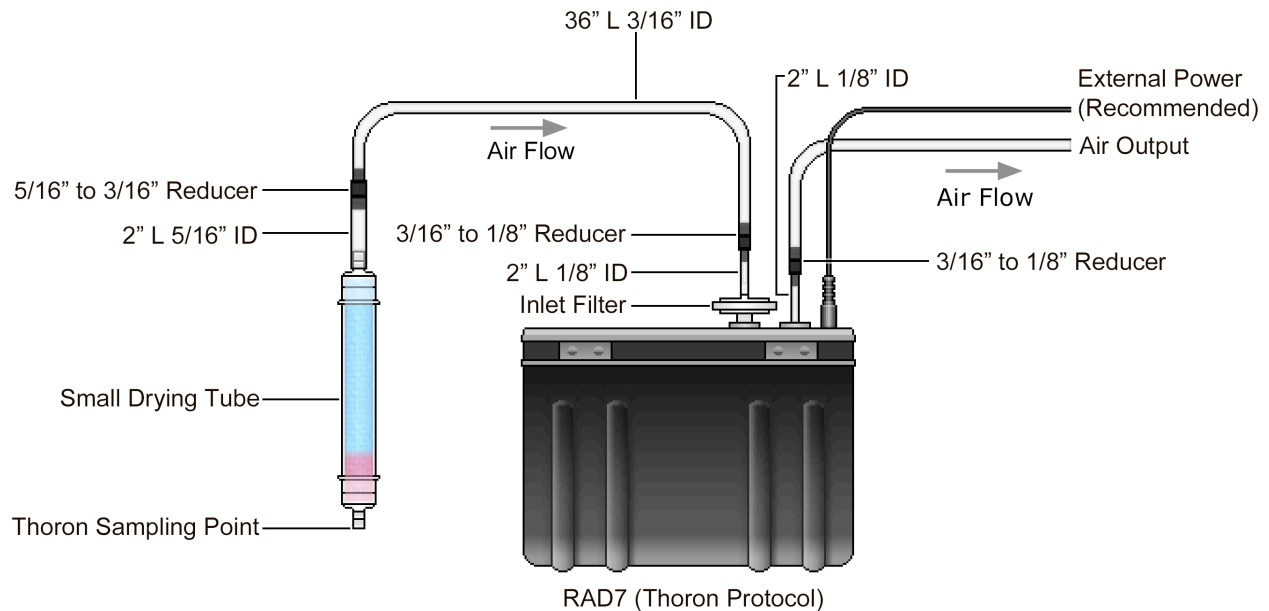

Recommended RAD7 Thoron Configuration

4.5.11 Thoron Measurements in Standard Radon Mode

When the RAD7 is configured to perform a standard radon measurement, it will detect both radon and thoron, but the thoron readings will be unreliable because most of the thoron will have decayed before it ever reached the RAD7's measurement chamber. This is because a standard radon measurement typically involves a larger drying unit and a lower average airflow rate than is stipulated for thoron measurements. However even under these unfavorable conditions it is often possible to apply adjustments to the reported thoron readings to determine the actual thoron concentration.

When the RAD7 is configured for measuring radon, a full-sized laboratory drying unit is typically used. Each cycle begins with five minutes of continuous pump activity, and then the pump typically operates for one minute in five for the remainder of the cycle. The thoron sensitivity will be about half normal (because of the laboratory drying unit) for the first five minutes, when the pump is running, and then close to 1% of normal for the rest of the cycle, due to the reduced pump activity. If the cycle is T minutes, the average thoron sensitivity will be:

$$(2.5 + 0.01*(T-5)) / T * \text{Thoron Sensitivity}$$

That means the thoron reading should be multiplied by the following factor:

$$T / (2.5 + 0.01*(T-5)).$$

Using this logic, if T is 30 minutes, then the scale factor will be around 10 or 11 times.

When RAD7 data is graphed in CAPTURE, thoron data will not be viewable on the graph by default unless the software detects that the RAD7 was configured optimally for the measurement of thoron. However thoron data can always be graphed by overruling CAPTURE's objections. More details are available in the CAPTURE user's manual.

4.6 Managing Background

A major concern in radon testing is background. The RAD7 has a number of features that help to keep short and long-term background under control. These are discussed in Chapter 3.11. Following a few simple rules will help to keep background to a minimum.

Short term background is activity left in the detector after the air sample has been flushed from

the measurement chamber. The higher the radon concentration and the longer the sample is held in the cell, the more daughter activity it leaves behind. So, to avoid background, when you see high radon readings, finish your measurement, and purge the sample cell promptly. Take the instrument somewhere with little radon, such as outdoors. Make sure the drying tube is connected, and select **>Test Purge**. Let the RAD7 purge for 5 to 10 minutes, or longer if the sample was exceptionally “hot”.

The two alpha peaks decay at different rates. The polonium-218 peak, in window A, decays with a 3.05 minute half-life. So in 10 minutes it will be down to about one-tenth of its original count rate. The peak in window C, however, will take over two hours to get down to one-tenth its count rate.

Rather than wait around for hours, you can start the next radon test in SNIFF mode, which ignores window C. In fact, the preset, one and two-day, monitoring protocols, in the RAD7, use AUTO mode, which starts a measurement in SNIFF mode and automatically changes to NORMAL mode after three hours. This takes care of all but extreme exposure to very high radon.

You can always measure the short-term background, with 5-minute SNIFF mode tests. Run a few to see that the background is low.

4.7 Airflow Rate Limits

When the RAD7's pump is set to OFF (**Setup, Pump, Off [ENTER]**), it is permissible to use an external pump device, such as the DRYSTIK, which may provide a higher or lower airflow rate than the RAD7's built-in pump. However certain flow rate limits should be observed.

High flow rates are useful for thoron measurement and for fast response RAD AQUA monitoring of radon and thoron in water. Low flow rates are useful for continuous soil gas monitoring and for sampling gases, such as stack gases, that need significant conditioning.

4.7.1 Maximum Airflow Rate

The maximum recommended airflow rate is 2.5L/minute. Beyond that rate the RAD7's sensitivity will eventually drop, because the very fast movement of air interferes with the electrostatic precipitation process. Airflow rates approaching the 2.5L/min limit are suitable for measuring thoron, which must be brought into the RAD7 swiftly due to its rapid decay.

If the RAD7 has been specifically calibrated for thoron however, the specified thoron sensitivity will remain in effect only when the RAD7 is configured exactly as instructed on the Thoron Calibration Certificate. Generally this entails operating the RAD7 in Thoron Protocol, causing its internal pump to run continuously, producing an airflow rate of about 800 mL/min.

4.7.2 Minimum Airflow Rate

If the RAD7's cycle time exceeds 5 minutes and its internal pump is set to Auto, the pump normally runs continuously to dry out the RAD7 until the RH drops below 10%. After that the pump runs for 5 minutes at the start of every cycle to put an entirely fresh sample into the measurement chamber, and thereafter for one minute in every five, to keep the air sample fresh. Therefore the typical average flow rate is less than 0.2L/min. For certain applications lower airflow rates may be preferred. To determine the minimum acceptable airflow rate, consider the following parameters:

- a) The distance from the sample source to the RAD7 (very slow flow rates may allow significant radioactive decay of the radon before it reaches the RAD7).
- b) Whether thoron is being measured (with a one-minute half life, sample decay during acquisition is significant).
- c) The required response speed of the RAD7 (a low flow rate may cause an unacceptably long time to change the sample in the measurement chamber).
- d) The radioactive decay during residence in the RAD7's measurement chamber.

Regarding point c), the amount of time it takes to change the measurement sample should be short compared to the required response time.

Regarding point d), the radon sample in the measurement chamber should have nearly the same concentration as the radon at the sampling point, to within a small fraction of the acceptable uncertainty. Ideally less than 1% of the original sample concentration will be lost to radioactive decay before the measurement occurs. This requires that the transit time from the sampling point plus the time that radon remains in the RAD7's chamber is less than one hour. The RAD7 has a volume of less than 1L, so a flow rate of 1L/hour, or 0.016L/min is sufficient to satisfy the residence criterion, but the response time to a step change in radon concentration at the sampling point would then be about 1 hour. For a 15min response time, the flow rate would have to be at least five times greater, or 0.08L/min.

The 3min half life of 218-Po limits the radon response time to a little less than 15 minutes, so there is little benefit in a flow rate greater than 0.1L/min unless the source is far away or thoron is being measured.

4.8 Harsh and Hazardous Environments

4.8.1 Splashing Water

Extra care should be taken to prevent water from splashing onto the RAD7 face plate or entering the instrument through the RAD7 inlet. Either situation can cause malfunctions and corrosion. If the RAD7 is to be operated in a harsh environment, such as a cave or mine, where water may splash around, the RAD7 may be protected in two ways:

- a) A thin plastic film may be stretched over the face plate and down the sides of the case. It can be pushed down around the hose connectors and plugs can be pushed into data and power sockets, pushing the plastic film down around the pins. The result is to make the instrument almost waterproof.
- b) The RAD7 can be enclosed in a large transparent plastic bag with the opening

gathered, and held with an elastic band, around the incoming air-sample tubing.

- c) The dry air from the RAD7 outlet may be exhausted to the interior of the bag, ensuring that the operating environment is clean and dry.

If water ever enters the RAD7, immediate steps should be taken to minimize the impact on the instrument. For detailed instruction see Section 8.4, Water Catastrophe.

4.8.2 Dusty Environment

Dust may contaminate the desiccant and cause elevated radon background due to radon emitted by trace amounts of radium deposited in the desiccant by the contaminating dust. To prevent this, a dust filter should be attached to the tubing at the sampling point, upstream of everything.

A suitable dust filter is supplied with every RAD7. The filter should be replaced when it becomes soiled. Replacements may be purchased from a car-parts supplier as 1960's VW Beetle in-line gasoline filters, part number 803-201-511C, or FRAM G4164, or from DURRIDGE Company.

Please note that any restriction to air flow, including a plugged dust filter, upstream of a passive DRYSTIK will reduce the effectiveness of the DRYSTIK. In a dusty environment, with a dust filter in place, an Active DRYSTIK will continue to work well even if the dust filter becomes partially blocked.

4.8.3 Radiation Hazard

If the RAD7 is to be placed in a location that is hazardous to the health of individuals, remote communication may be established through either a wireless Bluetooth connection or a local wireless network. For details please see Chapter 6, and the Long Distance Connectivity section of the CAPTURE user's manual. (The CAPTURE manual is available from within the program's Help Menu, as well as from the DURRIDGE website.)

5 USING RAD7 ACCESSORIES: TESTING SOIL AND WATER

5.1 Introduction

With the addition of various accessories offered by DURRIDGE, the RAD7 can acquire the ability to detect radon in water samples, flowing water, soil gas, hard and soft surfaces, and collected objects. These applications and the accessories required for each are described below.

The accessories discussed here are not included with the RAD7. For full details on the usage of a given accessory, please see its user manual. All product manuals are available in print form, and on the DURRIDGE website (www.durridge.com) in PDF format.

5.2 Radon in Water

5.2.1 The RAD H₂O and Big Bottle Systems

The RAD H₂O is an accessory for the RAD7 that enables you to measure collected water samples to detect radon with high accuracy over a wide range of concentrations, obtaining your reading within an hour of taking the sample. It is particularly suited for well water testing, where immediate results are often required.

The RAD H₂O uses a standard, pre-calibrated degassing system and pre-set protocols, built into the RAD7, which give a direct reading of the radon concentration in the water sample itself. The method is in fact a special variation of the grab sampling method described in the previous chapter.

The most widely supported sample sizes are 40 mL and 250 mL, as these correspond to the RAD7's built-in Wat-40 and Wat250 protocols. Large water samples of up to 2.5L may be sampled using a separate product, the Big Bottle System, in which radon concentrations are calculated using the provided CAPTURE software for Windows and macOS.

The RAD H₂O and Big Bottle System manuals contain further information on these products.



RAD H₂O



RAD AQUA

5.2.2 The RAD AQUA Accessory

The RAD AQUA accessory handles the continuous monitoring of radon in water, offering accurate results in as little as half an hour.

Applications for the RAD AQUA include testing water from running faucets and water being pumped from the bottom of a lake. In addition to its rapid response time, the RAD AQUA offers a high degree of sensitivity.

The RAD AQUA functions by bringing air into equilibrium with water passing through an exchanger in a closed loop. During this process, the RAD7 is set to operate in continuous mode, as described in Chapter 4.2.

Since the equilibrium ratio of radon in air to radon in water is affected by temperature, a temperature probe is used to collect water temperature data, and DURRIDGE CAPTURE software for Windows and macOS later accesses the RAD7 data and the water temperature data and calculates the final radon in water readings.

Users are encouraged to refer to the RAD AQUA manual for further details.

5.2.3 The WATER PROBE Accessory

The Water Probe is used to collect radon samples from large bodies of water. The probe consists of a semi-permeable membrane tube mounted on an open wire frame. The tube is placed in a closed loop with the RAD7.

When the probe is lowered into water, radon passes through the membrane until the radon concentration of the air in the loop is in equilibrium with that of the water. As with the RAD AQUA, the RAD7 data and water temperature data are collected simultaneously and accessed by CAPTURE to determine the final result.

As compared to the RAD AQUA, the Water Probe takes longer to make a spot measurement. However it does not require a pump, so power requirements are reduced.

5.3 Soil Gas Sampling

5.3.1 Application

The radon concentration in the soil gas surrounding a house is one of many parameters that impact radon health risk. The construction of the house, the porosity of the soil, the height of the water table, and several other factors are all important. Even if there is no radon in the surrounding soil, the house may still be at risk if it has a well in the basement, or is built on rock, over a fissure. Regardless, it is often of interest to determine the radon concentration in soil gas.

Thoron is usually associated with radon in the soil. When measuring soil gas, it is therefore particularly useful to determine the thoron content as well as the radon content. Should there be significant thoron, it may be used as a tracer, to find radon entry points inside the house. See Chapter 4.3.2 for details.

5.3.2 The Soil Gas Probe Accessory

The cost and complexity of a soil gas probe increases with the depth to which it can be inserted. A variety of probes are available from DURRIDGE, the simplest of which will penetrate to a depth of 3 feet.

5.3.3 Soil Gas Probe Preparation

For full details on using a soil gas probe, please refer to the appropriate user's manual found at the DURRIDGE website (www.durridge.com). The basic procedure can be summarized as follows.

Insert the soil probe. Make sure that there is a reasonable seal between the probe shaft and the surrounding soil, so that ambient air does not descend around the probe and dilute the soil gas sample.

Between the probe and the RAD7, connect the included water trap (which could be just a jar with two air-tight hose connectors in the lid). Then connect the laboratory drying unit, and the inlet filter. A water trap is included in the package when the DURRIDGE soil gas probe is purchased.

Set the protocol to Sniff. Soil gas is normally so high in radon that it is not necessary to use long cycle times to gain precision. Five minute cycle times are sufficient.

5.3.4 Running the Test

Start the test. (Test, Start, [ENTER]). On the LCD screen you will see the first status window. Push the right arrow twice and the screen will display the temperature, relative humidity, battery voltage and pump current. Pay particular attention to the relative humidity and pump current. The humidity should gradually drop down to below 10%, and stay there.

If the pump current starts to rise much above 100 mA, it suggests that the soil is not porous, in which case it may be that a good soil gas sample cannot be drawn, no matter how powerful the pump is. With the RAD7 pump current above 100 mA, the air flow rate will be significantly reduced from the nominal 1L/min. This will not affect the radon reading, but will reduce the effective sensitivity to thoron, as more of the thoron will decay en route to the RAD7. If desired, an additional pump may be used, but it should be placed upstream of the RAD7, so that the RAD7 is operating at normal pressure. In fact, with an external sampling pump in use, the RAD7 pump can even be switched off altogether.

5.3.5 Interpreting the Data

As with any Sniff test, the first two 5-minute cycles should be ignored. The next one or two cycles should be averaged, to arrive at the radon concentration of the soil gas.

For thoron, some estimate has to be made of the time taken for the sample, after it has left the soil, to reach the RAD7. This requires an estimate of the volume of the sample path, including the probe, water trap, tubing and drying unit, and an estimate, or measurement, of the flow rate. For example, if the total volume of the sample path is 2L, and the flow rate is 0.5L/min, then the sample delay is about 4 minutes. If the thoron decays by half every minute, then after four minutes the concentration will be just 1/16th of the concentration in the ground. So, the thoron

concentration measured by the RAD7 would be multiplied by 16.

5.4 Emission Measurements

5.4.1 Application

With its internal pump, sealed sample path, and inlet and outlet connectors, the RAD7 is well suited to the measurement of radon emissions from objects and surfaces. Furthermore, the ability to count only the polonium-218 decays means that dynamic measurements are clean, and not complicated by long-half-life events.

5.4.2 Open Loop Configuration

Emissions may be sampled from collected objects using DURRIDGE's Bulk Emission Chamber. It is also possible to analyze emissions from soft or hard surfaces, with the aid of a DURRIDGE Surface Emission Chamber, which consists of a plate-like enclosure capable of forming a tight seal around the surface in question. In both cases the RAD7 draws air from within the enclosed space, through the desiccant and inlet filter, and into the measurement chamber. The air may then be returned to the enclosure from the RAD7 outlet, to form a closed loop. Alternatively, in an open loop configuration the air being drawn from the enclosure may be replaced with 'zero' air from a cylinder, or with ambient air, which should have a low but known radon concentration.

With the open loop configuration, a steady and known flow rate must be established. If a cylinder of 'zero' air, or nitrogen, is used, then the RAD7's internal pump may be set to Off, and a pressure reduction valve and needle valve may be used to control the flow rate. With ambient air, the RAD7's internal pump may be set to On, for a continuous flow. In both cases, a flow meter is required. Once a steady state has been achieved, a long-term measurement may be made. The rate of emission will equal the increase in radon concentration times the flow rate. The precision will depend on the radon concentration and the duration of the measurement.

5.4.3 Closed Loop Configuration

In a closed-loop configuration, the system is first purged, then sealed. Next the radon concentration within the loop is monitored in SNIFF mode, with short, e.g. 15 min., cycle times, for a few hours. It is necessary to know the total volume of the closed-loop system. For this purpose the volume inside the RAD7 may be taken as 800 mL. The initial rate of increase in radon concentration (neglecting the first 15-min cycle), multiplied by the volume, gives the rate of radon emission. A reduction in the slope, as the radon level builds up, may be due to leaks in the system, or to a reduction in the net emission.

DURRIDGE's CAPTURE software can be used to view a graph slope line and inspect the change in radon concentration over time. The line should be set to begin after the initial response delay and before any observable drop from either leakage or decay. CAPTURE will express the slope of the line in the units of your choice.

5.4.4 Very Low Emission Rates

Very low emission rates can be measured by placing the sample in an airtight container with sealable inlet and outlet valves, and allowing the ingrowth of radon to occur over at least a week (after which the ingrowth must be calculated) and preferably a month or more (after which the ingrowth may be assumed to have reached equilibrium). The container is then connected to the RAD7 in a closed loop. The valves are opened and the RAD7 measures the radon concentration. The concentration rises as the radon is distributed around the loop. Eventually the concentration will settle to a slowly decreasing value.

5.4.5 Bulk Emissions

The DURRIDGE Bulk Emission Chamber is an airtight box with two well-separated hose connectors. The material to be tested is placed in the chamber, which is then connected to the laboratory drying unit, and thence to the inlet filter on the RAD7. The other box connector has tubing attached, which is either connected to the RAD7 outlet for closed-loop operation, or to a cylinder of zero gas or ambient air.

Note that bulk emissions are affected by pressure fluctuations and by temperature and humidity. All these parameters can and should be controlled in both the closed-loop and open-loop configurations. Radon emission is also dependent on the grain size of loose materials, and the porosity of any bulk material.

In addition to radon, thoron can also be measured in the Bulk Emission Chamber. In the open loop mode, a correction is required for the decay of the thoron during the time between its emission and measurement in the RAD7. In closed loop mode, another correction must be made for the portion of thoron that gets fed back to the enclosure. Note that for thoron, both the closed loop and open loop modes are steady-state measurements.

5.4.6 Surface Emission

DURRIDGE offers two surface emission chambers, one for solid hard surfaces, and another for soft soil surfaces. Each consists of a circular plate which is sealed against the surface under investigation. The Solid Surface Emission Chamber accomplishes this using a rubber seal, while the Soil Surface Emission Chamber uses a penetrating metal rim.

The measurement procedure is similar to that of the Bulk Emission Chamber described above. Once the total emission rate within the enclosure has been calculated, it may be divided by the area of the surface within the sealed boundary, to determine the emission per unit area.



Bulk Emission Chamber



Surface Emission Chamber

5.5 Supporting Accessories

5.5.1 Overview

DURRIDGE offers additional RAD7 accessories which improve the accuracy of radon and thoron reporting by optimizing operating conditions.

The RAD7 is able to detect radon in concentrations of up to 20,000 pCi/L (750,000 Bq/m³). For applications involving higher concentrations of radon, DURRIDGE offers the Range Extender, a device which removes 90% of the radon from the air sample entering the RAD7, giving the instrument the ability to operate in conditions under which it would otherwise be unable to cope. A final concentration figure is attained by multiplying the reported result by ten.

Another limitation of the RAD7 is that it loses reporting accuracy under high humidity conditions. The use of desiccant ensures that the air entering the RAD7 inlet is not too humid, but since desiccant is expended quickly when exposed to very moist air, DURRIDGE offers the DRYSTIK, an instrument which removes moisture from the air entering the RAD7 without removing the radon itself. The premium DRYSTIK model is capable of reducing the humidity of a typical air sample to 4% in under 20 minutes, greatly prolonging the life of the desiccant, or eliminating the need for it altogether.

The Range Extender and DRYSTIK are described in more detail below. For full documentation on each, please refer to the Range Extender and DRYSTIK user manuals, available in PDF format at the DURRIDGE Website (www.durridge.com).

5.5.2 The Range Extender

The Range Extender mixes fresh air with the air being sampled, reducing the concentration of radon entering the RAD7 by a factor of ten. This greatly increases the instrument's effective range.

The Range Extender consists of two parallel capillary tubes joined at one end to an outlet hose connector. Fresh air is fed to the input of one tube while the incident radon sample is fed to the other. A differential pressure sensor across the two tube inputs, with a needle valve for adjustment, is used to ensure that both capillary tubes have the same pressure drop across them. With this system the radon concentration delivered to the RAD7 is reduced by an order of magnitude, regardless of the strength and flow velocity of the RAD7's internal pump. The RAD7 pump can cycle on and off without affecting the reduction factor.

The Range Extender can be used for the measurement of very high radon concentrations in air, in soil gas, and in water. It can also be used with any other instrument that has its own pump, for any gas. If used to extend the range of thoron measurement, care must be taken to assess and correct for the additional decay of the thoron due to sample acquisition delay.



Range Extender

5.5.3 The DRYSTIK

The DRYSTIK reduces the humidity of the air entering the RAD7 by transferring moisture from the sample about to enter the RAD7 to the air being pumped out of the instrument. As the air enters the desiccant in the drying unit (which is not included with the DRYSTIK) on its way to the RAD7, it will have already lost most of its moisture, greatly extending the life of the desiccant in the drying unit. In certain cases the need for desiccant is eliminated altogether.

The DRYSTIK has at its heart a Nafion humidity exchanger with diaphragm pump, fixed and variable flow limiters, and a built-in Duty Cycle Controller. These are all contained in one of two enclosures, either standard or ruggedized. The DRYSTIK's pump compresses the sample air inside the membrane tubing, initiating the transfer of water molecules to the outer purge flow, drying the incoming air as it moves through the device.

The DRYSTIK is capable of bringing the relative humidity of air flowing at 0.15L/min down below 10% in less than four hours, and maintaining the RH below 6% indefinitely without any desiccant. This allows a RAD7 to operate under optimum conditions with the highest sensitivity and lowest operating cost. At a higher flow rate of 1.2 L/min, the DRYSTIK can bring the RH down below 12%, which is sufficient for enhanced-sensitivity thoron measurement.

For soil gas measurement, the DRYSTIK provides a high flow capability, supporting the detection of short-lived thoron. For radon, the ability to lower the flow with the built-in Duty Cycle Controller means that continuous soil gas readings may be made indefinitely, without any risk of fresh air diluting the soil gas sample by diffusing from the surface down to the extraction point. Given its versatility, the DRYSTIK is effective for a wide range of applications.



DRYSTIK (Model ADS-3R)

6 COMPUTER CONNECTIVITY

6.1 Computer Connectivity Basics

The RAD7's built-in serial port allows you to transfer radon data to your computer and to communicate with the device remotely in real time. DURRIDGE provides a free software utility for Windows and macOS called CAPTURE, which makes it easy to perform these actions, as well as to monitor the RAD7's status, graph radon and thoron data, apply corrections to account for environmental factors, browse RAD7 data on a cloud-based service, and export the data for analysis in a spreadsheet program or other software.

It is also possible to use a terminal emulator program to interface with the RAD7, and to write your own RAD7 communications software using the protocol documented later in this chapter.

An overview of the CAPTURE software is provided in Section 6.2, and the full program documentation is available at www.durridge.com/capturehelp/. This documentation is also accessible from within the CAPTURE application, using the Help menu. For troubleshooting RAD7 detection problems in CAPTURE, please refer to the program documentation or to Section 8.7, CAPTURE RAD7 Detection Failure, in this manual.

Following the section on CAPTURE, the remainder of this chapter contains technical information which will be of interest to advanced users who intend to communicate with the RAD7 via a terminal window and those who wish to write their own software for communicating with the RAD7.

6.1.1 Connecting the RAD7 to the Computer

On most systems the RAD7 should be connected to the computer using the included USB to Serial adaptor, and it will be necessary to install the included adaptor driver software. If your computer has a physical serial port however, it is possible to instead use an RS232 DB9 female to female null modem cable to connect the RAD7 directly to the computer, without the need for adaptors or drivers.

The diagrams on the next page show how to connect the RAD7 to a computer using two different kinds of USB to Serial adaptors: the StarTech adaptor (top), and the Keyspan adaptor (bottom).

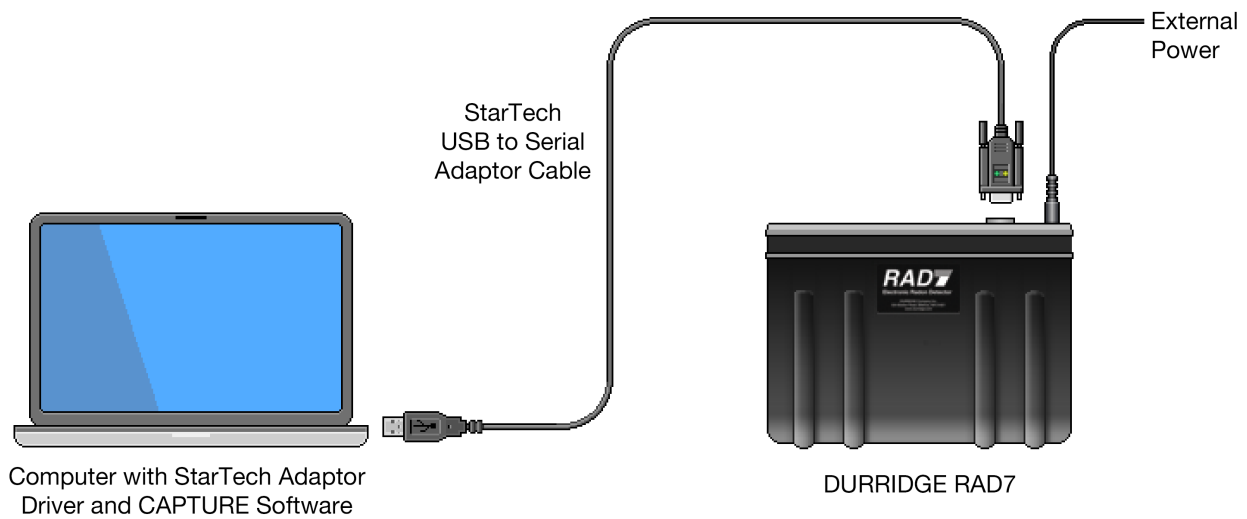

Connecting the RAD7 to a Computer with the StarTech Adaptor

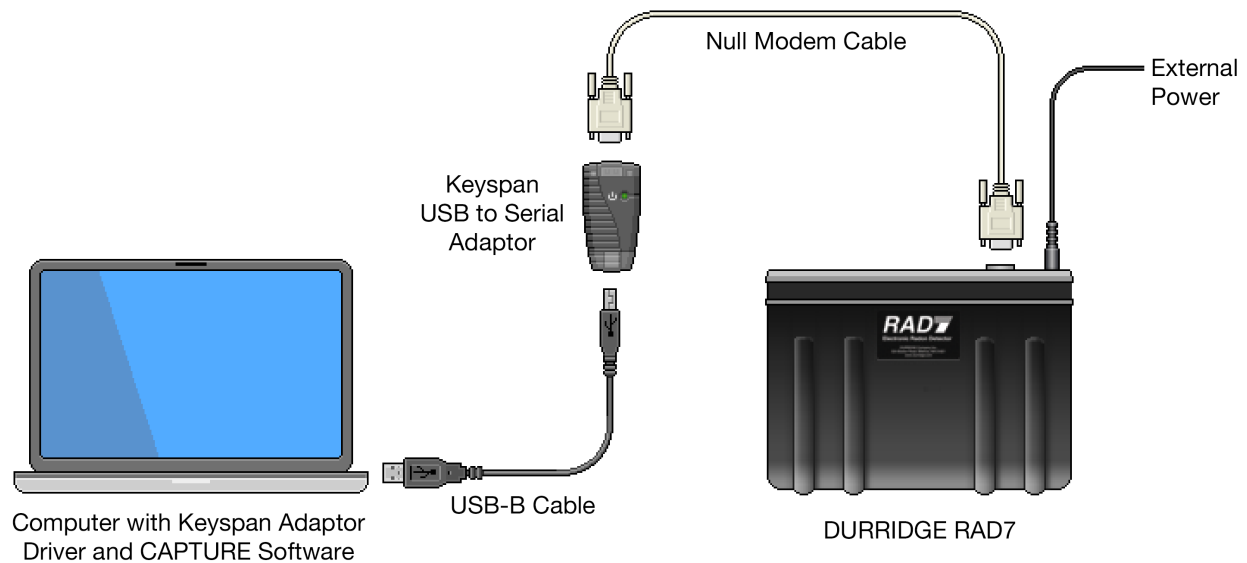

Connecting the RAD7 to a Computer with the Keyspan Adaptor

It is recommended that the RAD7 remain plugged into external power to prevent its battery from dying while it is connected to the computer.

For connecting more than one RAD7 to a computer, it is possible to use several USB to serial

adaptors simultaneously, with each plugged into a USB port on the computer (it is not advisable to plug multiple adaptors into a single USB hub.) Alternatively, a multi-port USB to serial adaptor may be purchased.

6.2 CAPTURE Software

6.2.1 Introduction to CAPTURE

CAPTURE simplifies the transfer of data from the RAD7 to a computer. It also provides a wealth of graphing and data analysis options, plus the ability to export data to other programs for further review. Additionally, CAPTURE can store RAD7 data on the a cloud-based internet server, where it can be browsed and shared.

CAPTURE software can be downloaded for Windows or macOS from <https://durridge.com/software/capture/>.

This section provides a brief overview of the CAPTURE software. Complete CAPTURE documentation is available at https://durridge.com/documentation/capture_help/.

6.2.2 CAPTURE Installation

On Microsoft Windows, an installer program will install the necessary components and place shortcuts in the Start Menu and on the desktop, if desired. To install CAPTURE for macOS, open the downloaded .dmg disk image file and drag the CAPTURE application into the Applications folder.

Next connect the RAD7 to the computer using the provided adaptor cable as described in Section 6.1.1.

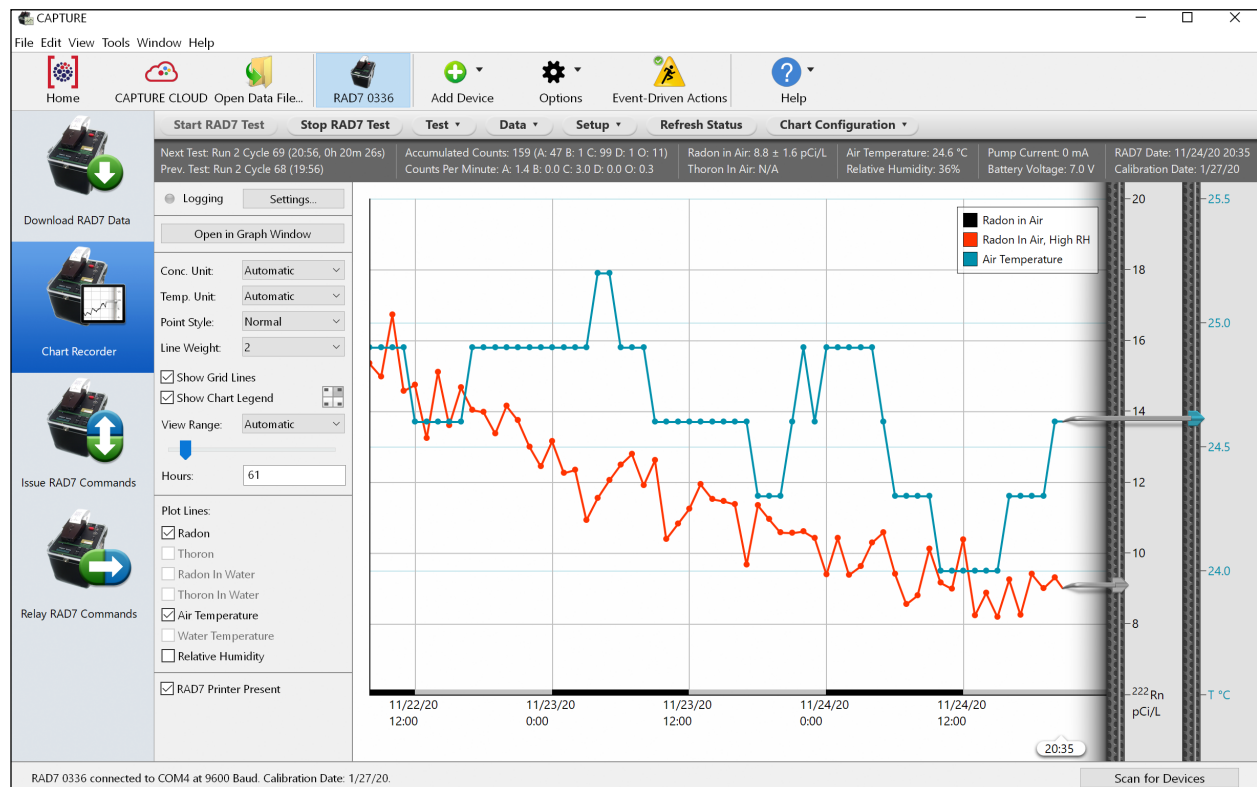

CAPTURE Software running on Windows

6.2.3 Feature Summary

CAPTURE's capabilities fall into four main categories: downloading RAD7 data, graphing and analysis, real-time RAD7 monitoring, and CAPTURE CLOUD. An overview of each is described below.

6.2.4 Downloading RAD7 Data

CAPTURE's original and primary function is to download RAD7 data. Once connected to a RAD7, the program can download all of the device's data, or a particular data run. For a more complete record set, supplementary output containing thoron concentration records may also be obtained. When a download operation is complete, the results are saved to disk in the format of the user's choice.

In addition to being able to download data from RAD7s connected directly to the computer, CAPTURE can obtain data from RAD7s connected via bluetooth, a local network, or the internet.

6.2.5 Graphing and Analysis

Once RAD7 data has been downloaded and saved to disk, it may be displayed as a graph. CAPTURE's Graph Window allows for the display of radon, thoron, temperature, and humidity data. Navigation controls make it possible to select the data points within a specific date range and zoom in to that region for a closer look.

Accompanying the graph display is a statistics panel showing information about the point nearest to the cursor and the points within the selected region, as well as the points comprising the entire data set.

A spectrum display appears in another panel, providing an indication of the changes that occur within the RAD7 as a testing session progresses.

RAD7 Profiles based on device calibration data may be applied to graphs to improve the accuracy of the data shown. Data points may also be corrected with respect to temperature, humidity, and other variables. Any problematic data records

will be examined by CAPTURE's comprehensive error catching system and reported to the user.

CAPTURE supports the exporting of both raw RAD7 data and more complete error-corrected RAD7 data in a number of formats, for use in spreadsheets and other analysis tools. Summary reports may also be generated, providing general overviews of the collected data.

6.2.6 Real-Time RAD7 Monitoring

CAPTURE is capable of monitoring multiple local and remote RAD7s simultaneously in a Chart Recorder, displaying status details and plotting radon concentrations in real time as they are recorded. A statistics panel is automatically refreshed as new information arrives.

In addition to being able to track the state of each connected RAD7, it is also possible to issue menu commands, performing such tasks as starting and stopping tests and setting the device protocol. Nearly all of the functionality of the RAD7's physical controls is accessible from within CAPTURE's graphical interface.

As stated above, it is suggested that users examine the complete CAPTURE documentation, which is available from within the program's Help menu. If CAPTURE fails to detect a connected RAD7, troubleshooting solutions can be found in Section 8.7 in this manual.

6.2.7 CAPTURE CLOUD

CAPTURE CLOUD is a subscription-based service for storing, organizing, and sharing RAD7 data from any computer running CAPTURE. Shared data can be made accessible to authorized CAPTURE CLOUD users.

When signed in to CAPTURE CLOUD, RAD7 data can be saved to a CAPTURE CLOUD server hosted by DURRIDGE, and then later retrieved, modified, and saved back to the server. The CAPTURE CLOUD Browser lets you explore collections of RAD7 record sets, and issue search queries to find data from a particular organization, RAD7 instrument, or date range.

6.3 RAD7 Communication Protocol

6.3.1 Communication Requirements

Although DURRIDGE's CAPTURE software for Windows and macOS provides a complete solution for downloading RAD7 data and issuing RAD7 commands, it may be desirable to communicate with the device using a terminal window, or with custom communication tools designed to fulfill specific needs.

The RADLINK firmware, installed standard with every RAD7 sold, enables the RAD7 to respond to commands issued through its serial port. With RADLINK installed, all of the commands available through the RAD7 keypad will also be available via the serial port. From a computer you may, for example, change the RAD7's operating parameters, complete a test, and then download the accumulated data.

6.3.2 RAD7 Command Format

The format of commands issued to the RAD7 serial port generally match, as closely as possible, the format of the commands available to the user at the RAD7 keypad. For example, the command to change the cycle time to 1 hour is "SETUP CYCLE 01:00". The command to turn off the audio beeper is "SETUP TONE OFF". The command to send over the data from run number 3 in comma-delimited form is "DATA COM 3". (This particular command is described further in Chapter 6.3.3, Parsing RAD7 Data.)

Besides the ordinary RAD7 commands, additional commands have been implemented via RADLINK which add functionality and in some cases substitute for other commands. These commands all start with the word "SPECIAL". One such command is "SPECIAL STATUS", which gives information about the current status of the instrument. It is like "TEST STATUS", but does not continue to update the information every second; instead, it returns control to the user.

The third standard ASCII character, ETX, functions as a remote "menu" key that can be used to interrupt certain RAD7 activities and prepare it to accept a new command. The RAD7 replies with

a prompt, the greater-than character ">", that tells you it is ready for a new command. When using a terminal emulator program, you will always type commands at the prompt.

All commands must be followed by a carriage return (the thirteenth standard ASCII character), denoted here as <CR>. No command will be activated until the <CR> goes through. Once you have typed a command, always end with a carriage return keystroke. This key may be marked "Enter" or "Return" on your keyboard.

If the RAD7 cannot understand your command, for example if you typed words in the wrong order or misspelled something, it will respond with

?ERROR

followed by a list of acceptable command words. The case of the command does not matter, nor does the numeric format of numbers. In the last example, "data com 03", "Data Com 3", and "dAtA cOm 03.00" all work equally well.

6.3.3 Parsing RAD7 Data

Stored RAD7 data can be obtained through the "Data Com ##" command. Specify the run number in the command line and finish with a carriage return. Alternatively, issue "Special ComAll" to download all runs from the RAD7.

Each cycle produces a record containing 23 fields. Carriage-return line-feeds separate the records, and within each record, commas separate the fields. Fields may have leading zeros, extra space characters, trailing decimals, etc., which may need to be trimmed. When the RAD7 responds to a Data Com or Special ComAll command, each line returned represents a different cycle. Here is an example of a single line:

```
009,99,10,29,04,18,4823.,337.8,45.4,
2.9,46.6,0.3,2201,14,23.7,5,7,
7.09,00,125,28.32743,.8500846,
255<CRLF>
```

The meaning of each of these values is described in the table on the next page.

Table 6.3.3 RAD7 Data Record Content

ID	Field Name	Notes
1	Record Number	Ranges from 001 to 999
2	Year	2 digit value
3	Month	2 digit value
4	Day	2 digit value
5	Hour	2 digit value
6	Minute	2 digit value
7	Total Counts	Integer indicating total counts recorded during test
8	Live Time	Expressed in minutes
9	Percent of total counts in win. A	These 4 windows will not always add up to 100% since counts can come into channels below or above these windows.
10	Percent of total counts in win. B	
11	Percent of total counts in win. C	
12	Percent of total counts in win. D	
13	High Voltage Level	Ranges from 2200V to 2300V
14	High Voltage Duty Cycle	Ranges from 0-100%; typically 10-20%
15	Temperature	Measured in °C or °F depending on RAD7 setup
16	Relative humidity of sampled air	Should be kept below 10% for most accurate test
17	Leakage Current	Ranges from 0 to 255. Above 20 is cause for concern.
18	Battery Voltage	Below 6.00V is a discharged battery. Does not affect accuracy of test but indicates need for recharge.
19	Pump Current	Ranges from 0-260mA. Typically 40-80mA; Above 100mA possible clogged filter or obstruction.
20	Flags Byte	This is a number between 0 and 255 which represents one data byte consisting of eight individual bits: Bits 0 and 1 indicate the pump state: either Off (0,0), On (0,1), Timed (1,0), or Grab (1,1). Bit 2 is not defined. Bit 3 indicates whether Thoron is On, in which case the thoron reading appears on the end-of-cycle printout. Bits 4 and 5 indicate the measurement type: either Radon in Air (0,0), Wat-40 (1,0), or WAT250 (1,1). Bit 6 indicates whether the RAD7 is in Auto mode, meaning it changes from SNIFF to NORMAL after the first 3 hours. Bit 7 indicates whether the RAD7 is in SNIFF mode.
21	Radon concentration	Expressed in pCi/L, Bq/m ³ , cpm, or # counts, depending on the units the RAD7 has been set to use.
22	Radon concentration uncertainty	The two-sigma uncertainty of the radon concentration, expressed in the same units as the base value.
23	Units Byte	This is a number between 0 and 255 which represents one data byte consisting of eight individual bits: Bits 0 and 1 indicate the concentration unit: either Bq/m ³ (0,1), pCi/L (1,1), counts per minute (0,0), or total number of counts (1,0). Bit 2 through Bit 6 are not defined. Bit 7 indicates the temperature unit used on printer output, either Celsius (1) or Fahrenheit (0).

6.3.4 Terminal Emulator Tips

If you are using a terminal emulator application to interact with the RAD7, you can gain access to additional functionality by making sure the terminal has been set up to give ANSI standard escape codes for the function keys and cursor control keys. Set the terminal for either ANSI, VT-52, or VT-100 mode to get these functions. The function keys F1, F2, F3, and F4 act as a remote RAD7 keypad, corresponding to the RAD7 keys [MENU], [ENTER], [←], and [→]. The Control-C character also acts as the remote [MENU] key (ETX). The backspace/delete key on your keyboard allows you to correct misspelled commands before the carriage return. If this key does not work, then Control-H may handle the same function.

6.4 Serial Port Specifications

6.4.1 Communication Protocol

The RAD7 serial port follows RS-232C convention for signal levels. Positive voltage (+3V to +15V) indicates logic state 0 (SPACE), while negative voltage (-3V to -15V) indicates logic state 1 (MARK).

The connector pin-out follows the IBM PC convention for the 9 pin serial port. The handshaking lines (DTR, DSR, RTS, and CTS) are not fully implemented, and should be considered non-functional (NF), but X-on/X-off flow control can be used.

Table 6.4.1a Serial Port Pin Assignments

Pin	Function	Comment
1	Carrier Detect (CD)	NF
2	Receive Data (RD)	
3	Transmit Data (TD)	
4	Data Terminal Ready (DTR)	NF
5	Signal Ground (SG)	
6	Data Set Ready (DSR)	NF
7	Request To Send (RTS)	NF
8	Clear To Send (CTS)	NF
9	Ring Indicator (RI)	NF

The RAD7 serial port implements two-way communication at 300, 600, 1200, 2400, 4800, 9600, and 19200 bits per second (baud); these speeds are available through the 'Special' commands of the RADLINK remote control package. The default speed is 1200 bps.

If a terminal emulator or custom software application is used, communication should be conducted at a data rate not exceeding 9600 baud. This will significantly reduce the risk of characters being dropped from sent commands.

Table 6.4.1b Communication Parameters

Default Rate	1200 bps
Maximum Rate	19200 bps
Recommended Rate	9600 bps
Data Bits	8 bits
Parity Bit	None
Stop Bits	1 bit

The RADLINK remote control software resides in the RAD7's non-volatile memory (NVRAM), but its presence does not decrease the amount of memory available for storing radon data.

6.4.2 Extending the RS-232 Range

The simple, direct serial port to serial port connection has a range limited to around 50 feet (15 meters) by the RS-232-C standard. Options for extending this range include RS-232 line boosters, current-loop and other types of interface converters, short-haul modems, and leased-line modems.

You may use standard data modems to communicate over the telephone system to one or more remote RAD7 monitors, so that when you want to get some data or start a new run, just "dial up" the instrument of your choice. The modem should be Hayes compatible and should be set to auto-answer.

The CAPTURE user's manual contains a section titled Long Distance Communication, detailing several strategies for communicating with distant RAD7s that are fully supported by CAPTURE. These include the transmission of commands via Bluetooth, local area networks, and more.

7 MAINTENANCE

If the RAD7 is treated with respect, the only maintenance required is its regular recalibration. For this, it should be returned to DURRIDGE Company, who will check the health of the instrument, and who will incorporate the new calibration factors in the instrument firmware.

If the instrument is to be used in a harsh environment, where water and/or mud may be splashed on the face plate, the RAD7 should be put in a box or large transparent plastic bag. The air input may be brought into the container by a plastic tube from the sampling point. The air outlet should be left in the container, so that the RAD7 becomes surrounded by clean and dry air.

7.1 Accessories - Usage and Care

7.1.1 Desiccant

Two sizes of desiccant tubes are supplied. In the NORMAL mode, use the large 2" diameter tube (laboratory drying unit). This unit will last for days under continuous operation at high humidity before it needs regeneration.

When used as a Sniffer, the small desiccant tube is recommended. It will last for several hours before replacement or refilling of the tube is necessary. To regenerate the desiccant, the granules should be removed from the tube and spread evenly in a thin layer on a metal or Pyrex glass tray. Heat at about 200°C (400°F) for at least two hours or until granules turn uniformly blue. Allow the desiccant to cool in a closed, but not airtight, container before refilling the acrylic laboratory drying unit or small drying tube.

The following sections provide insight into how long the desiccant will last in various scenarios.

7.1.2 Laboratory Drying Unit

The column holds approximately 500 grams of Drierite desiccant. This desiccant can adsorb at least 10% of its weight in water, so the water capacity of the column is at least 50 grams. The RAD7 pump develops a flow rate of about 1L/min. With the RAD7 set for continuous monitoring with timed pump operation, the pump operates 20

to 30% of the time. We will assume an average flow rate of 0.3 liters per minute.

The following table shows the expected lifetime of a charge of desiccant in the Laboratory Drying Unit under various temperature and humidity conditions.

Table 7.1.2 Laboratory Drying Unit Life

RH	Deg. C	Deg. F	Column Life
30%	20	68	23.1 Days
30%	35	95	9.8 Days
50%	20	68	13.3 Days
50%	25	77	10.0 Days
90%	10	50	13.7 Days
90%	15	59	10.0 Days
90%	20	68	7.4 Days
90%	25	77	5.5 Days
90%	30	86	4.2 Days

7.1.3 Small Drying Tube

The small drying tubes each contain 30 grams of Drierite desiccant. The water capacity of each tube is 3 grams. We will assume that the RAD7 pump operates continuously, for an average flow rate of 1L/min. The following table shows the expected lifetime of a small drying tube under a variety of temperature and humidity conditions.

Table 7.1.3 Small Drying Tube Life

RH	Deg. C	Deg. F	Tube Life
30%	20	68	10 Hours
30%	35	95	4.2 Hours
50%	20	68	5.7 Hours
50%	25	77	4.3 Hours
90%	10	50	5.9 Hours
90%	15	59	4.3 Hours
90%	20	68	3.2 Hours
90%	25	77	2.4 Hours
90%	30	86	1.8 Hours

7.1.4 Cascading Drying Tubes

To extend the time before desiccant depletion, you may cascade several drying tubes in series. Two factors limit the number of drying tubes you can use. First, each additional drying tube or column adds a small amount of resistance to the air flow, so the pump will have to work a little harder. But the resistance added by a drying tube is much less than the resistance of the inlet filter, so you should be able to cascade several without severely restricting the air flow. Second, each additional tube adds a time lag between sample intake and instrument response.

For continuous monitoring, a 10- to 20-minute lag may be perfectly acceptable, but for sniffing it may not be. You can conservatively estimate the time lag by taking four times the volume of the drying system and dividing it by the average flow rate. Consider a continuous monitor application using a laboratory drying column (with an internal air volume of approximately 400 mL) with the pump in timed operation, giving an average flow rate of 0.2 liters per minute. Four times the volume divided by the flow rate gives 8 minutes for the estimated lag time. This would be perfectly acceptable for continuous monitoring. For radon sniffing, you will usually use the small drying tubes (with internal air volume of 23.7 mL), which create negligible delays of less than a minute, even at low flow rates. You can cascade several small drying tubes without trouble.

Do not cascade drying tubes when sniffing for thoron, since thoron's 56-second half-life necessitates that you keep delays to an absolute minimum. For thoron sniffing, use a single small drying tube, and set the pump for continuous (on) operation. Keep hose length to 3 feet (1 meter) in keeping with the Standard Thoron Setup.

7.1.5 Filters

Inlet filters are supplied that fit the metal inlet fitting (male Luer type). These filters block ultra fine dust particles and all radon daughters from entering the RAD7 test chamber.

The filters are manufactured in various pore sizes by several companies, including Millipore and SRI. We favor pore sizes of 1.0 microns or less;

pore sizes as small as 0.4 microns can be used with the RAD7 pump.

The filter should be replaced when it has become noticeably discolored or has clogged enough to impede the flow of air. If you cannot suck air easily through the filter yourself, it's time to change the filter.

When you operate the RAD7 in construction areas or basements, dust can quickly build up in sampling hoses, drying tubes, and inlet filters. This dust will slowly clog the filter, restrict air flow, and create strain on the pump. You will have to replace the inlet filter. To greatly slow the buildup of dust, we recommend that you attach a "prefilter" to the intake of the sampling hose, to prevent coarse dust particles from entering. Then, the inlet filter will remove the ultra-fine dust particles that pass through the prefilter and drying system.

We find that automotive gasoline filters can serve as convenient and inexpensive prefilters. A particular filter, intended for Volkswagens, is a small, disposable, clear-plastic capsule containing a pleated paper filter. This filter effectively removes most dust from the air stream, greatly extending the life of the inlet filter. You can buy this type of filter in almost any auto parts store for around \$3.

7.1.6 Batteries

Your RAD7 has enough battery capacity to go for two to three days without any external power source. Electronic circuits control the charging and discharging of the battery, avoiding overcharge or destructive discharge. If you maintain the batteries according to the following directions, you can expect to get two to five years of heavy service from them.

Keep the batteries fully charged as much as possible. Try to recharge promptly after use. The RAD7 batteries charge whenever the unit has DC power. With the power cord plugged in and the RAD7 measuring radon, the batteries will charge slowly. Full recharge takes about 48 hours.

With the power cord plugged in and the RAD7 in fast charge mode (not measuring radon), the batteries will charge more quickly. Full recharge

takes about 24 hours. The battery voltage indicator on the display (go to Status Window 1) will reach 7.10 to 7.20V when the batteries are fully charged and the power cord is still plugged in.

If the batteries are deeply discharged, to the threshold of battery damage, an electronic circuit will completely disconnect them to avoid further discharge. The circuit will then not allow battery operation until they are completely recharged. If this occurs, you may still be able to operate the RAD7 from DC power until the batteries recharge. Expect the recharge to take 48 hours.

Never store the RAD7 without first recharging the batteries. If you intend to store the RAD7 for a long period of time, you must recharge the batteries at least every four months, as they can be damaged by self-discharge on the shelf. Otherwise, you may have to replace the batteries before you can use your instrument again.

Battery voltage can be read from the Status display, and appears on printed output. A fully charged battery will rest at 6.40 to 6.50V. As the battery discharges, its voltage drops steadily to 6V.

If the battery voltage ever goes below 6.00V, it is fully discharged and should be recharged as soon as possible. As the battery charges, its voltage rises steadily until it goes above 7V. Consider the battery fully charged if it charges at or above 7V.

7.1.7 Real-time Clock and Non-volatile Memory

The RAD7's Real-Time-Clock (RTC) and Non-Volatile Memory unit (NVRAM) allows the RAD7 operator to switch power off without losing data or disrupting the clock time and date. These functions are powered by a lithium cell with an expected lifetime of ten years.

7.1.8 Printer and Adapter

Infrared printer documentation is provided in Appendix A at the end of this manual. It is important to familiarize yourself with its operation, and to be aware that the printer operates through an infrared optical link and should be positioned on the top of the RAD7 to match the data link on the detector. The printer runs on its own batteries.

7.2 RAD7 Operating ranges

Parameter	Minimum Value	Maximum Value
Temperature	0°C (32°F)	45°C (113°F)*
Relative Humidity, external <i>(Must be non-condensing)</i>	0%	100%
Relative Humidity, internal	0%	10%
Battery Voltage	6.00V	7.20V
Pump Current <i>(pump off)</i>	0mA	10mA
Pump Current <i>(pump on)</i>	30mA	90mA
High Voltage	2100V	2400V
High Voltage Duty Cycle	8%	20%
Leakage Current <i>(room temp.)</i>	0	20
Leakage Current <i>(max. temp.)</i>	5	80
Signal voltage level	0.15V	0.30V

Table 7.2 RAD7 Operating Ranges

*Note: The RAD7 should not be placed in direct sunlight if the outside temperature is over 100° Fahrenheit (38° Celsius). Instead it should be moved to a shady location.

7.3 Service and Repair

7.3.1 Calibration

DURRIDGE maintains a professional radon calibration facility that includes a controlled, standard source of radon gas, and a controlled-temperature environmental chamber. All RAD7 alignment and calibration is done here, as well as basic testing and quality assurance. We determine calibration factors by direct comparison to "master" RAD7s, which were themselves compared with EPA and DOE instruments, and which have participated in international inter-comparisons of radon instrumentation. The calibration accuracy is independently verified by direct determination of the radon chamber level from the calibrated activity and emission of the standard radon source. In addition, we periodically intercompare with other radon chambers. We generally achieve a reproducibility of better than 2% with our standard RAD7 calibration. Overall calibration accuracy is in the range of 5%.

The U.S. EPA recommends that continuous radon monitors such as the RAD7 be calibrated at least once per year, and DURRIDGE agrees. DURRIDGE's standard RAD7 calibration procedure requires 10 days from the receipt of the instrument. As a preliminary to recalibration, we give every RAD7 an inspection and test its critical parts. If additional service is required, this may delay the return of the instrument.

At present, only DURRIDGE can make adjustments to your instrument's alignment and calibration factors. If you determine, on the basis of an independent intercomparison (e.g., another calibration chamber) that you would like to adjust your RAD7's calibration by a known amount, we can generally perform this service and send back your instrument within one day. Requested calibration adjustments of more than 10% are considered highly unusual and require the written permission of the instrument's owner.

7.3.2 Repair

If you discover that your RAD7 is malfunctioning, we recommend that you first call DURRIDGE and talk to a technician. A surprising number of minor "disasters" can be avoided by long-distance consultation. The next step, if consultation fails, is usually to send your instrument in for evaluation and repair. Please send any documentation of the problem that you might have (notes, printouts, etc.) and a short description of the problem. This information may be emailed to us at service@durrige.com. Be sure that you put your name and contact information on the note. Within 48 hours of our receipt of the instrument, we will call you to give a diagnosis.

Bear in mind that RAD7 repairs involve a re-calibration of the instrument, which takes time. If you need a RAD7 during the repair time we may be able to provide a loaner instrument.

7.3.3 Shipping

1. You can send us your RAD7 at any time to either one of our Calibration facilities (USA and UK), listed below (**see important, specific instructions for each below**).
2. We need the RAD7 in house for 10 days, so the total time a RAD7 will be away from your facility will be 10 days plus the time the RAD7 spends in transit. If additional service or repair is required, this may delay the return of the instrument.
3. When sending your RAD7, please send the instrument only, without the cables and accessories. Pack the instrument upright in a box with one-inch (2.2cm) padding all around. A 14x14x14in (or 36x36x36cm) box is suitable. Pack the box well, and seal it carefully. Please include your contact info with the package.
4. International customers must be very careful, to avoid substantial extra shipping charges and delays, both for shipping to the nearest calibration facility, and for its subsequent return.

5. Commercial Invoice check-list (for international shipping only)

- For your courier or freight forwarder, you will need to provide a **Commercial Invoice**.
- Write only in English on the commercial invoice.
- Use the following description for the RAD7: “Used RAD7 Electronic Radon Detector”.
- Insured value US\$2,490.
- State on the invoice that the instrument is **MADE IN USA** and that it is being “**returned to the manufacturer temporarily for repair and recalibration**”.
- Use the HS (Commodity) code 9030.10.00.
- Mark the box with the serial number of the RAD7 (as the RMA – Return Merchandise Authorization).
- Add the phone number of the Calibration facility you choose, in case the Customs Office wants to call us.
- Next, you must ensure that your courier (i.e. UPS, FedEx) or freight forwarder will **deliver the package to our door**. The formal “INCOTERM” for this is “DDP”, which means “Delivered Duty Paid.”
- We will not pay or be responsible for USA or UK import duties, or Customs clearance charges. Your shipper must be told this when you arrange your shipment.
- It is important to make sure you prepare all the documentation you need to reimport the goods back into your country without being charged.
- For the Return to you:** unless you instruct us otherwise, we will return your RAD7 via the same shipping method you used to deliver it to us, Freight Collect. DURRIDGE can pay for the return shipment CPT (“Carriage Paid To”) to you, but our cost will be invoiced to you before shipment.

If we can help further, please email us at service@durridge.com.

Specific info for SHIPPING TO OUR USA FACILITY (from outside the USA):

DURRIDGE Company, Inc.
900 Technology Park Drive
Billerica, MA 01821-2812, USA
Phone: (+1) 978-667-9556
Fax: (+1) 978-667-9557

Declaration Form

There needs to be documentation proving that the instrument was previously imported into your country, otherwise you may be charged import duties when the instrument is returned to your country.

Please fill out the **declaration form** provided at <http://durridge.com/services/rad7-calibration/>. Attach the completed declaration form to the commercial invoice. If the invoice is scanned and submitted electronically, please scan the declaration form and submit it electronically as well.

Specific info for SHIPPING TO OUR UK FACILITY:

DURRIDGE UK Ltd.
Sheffield Technology Park
Cooper Buildings
Arundel Street
Sheffield S1 2NS, UK
Phone: +44 (0)114 221 2003

Please complete the checklist in the above section. It is very important to include the HS (Commodity) code 9030.10.00, otherwise import duty may be charged at the UK border, for which you will be liable. Please also include our EORI number GB219670885000.

Please ensure that you make the necessary arrangements with the Customs authority in your territory for the return of your instruments. There may be special procedures for temporary exports. For example, you may need to provide documentary evidence that the instrument was previously imported into your country, to avoid being charged import duty again.

7.3.4 Upgrades

Whenever you send your RAD7 in for repair or calibration, you have the option of having the latest available software installed. Most RAD7s can be upgraded to the latest hardware configuration as well. You will be informed periodically of whatever new features are available for your RAD7. Please advise us if you want to have an upgrade made. We intend to keep our RAD7 customers happy by keeping their instruments up-to-date and state-of-the-art.

7.4 RAD7 Quality Assurance

While the annual inspection and calibration, carried out by DURRIDGE Company, is the most effective quality assurance, and the prime requirement of EPA, there are other tests and observations that may be made that will give assurance of good performance throughout the year.

7.4.1 Spectrum

At least once a month, the spectrum printed by the IR printer should be observed. The cumulative spectrum, printed at the end of a run, has the most data points and is, therefore, the most useful for this purpose. All that is required is that the printer be placed on the face plate at the end of a 1-day or 2-day run. It doesn't matter what format is chosen, the summary printed at the end of the run will conclude with a cumulative spectrum, after the bar chart.

Alternatively, the RAD7 will print a spectrum at the end of every cycle if the format is set to LONG. However, this will include only the counts during that cycle. For the spectrum to be useful it should have at least 100 counts. There should be clearly defined peaks and little or no noise across the spectrum. The peaks should be located in the middle of the windows. A clean spectrum is indicative of an instrument in perfect working order, and hence of reliable and accurate readings.

7.4.2 Spill Factor (C Window to B Window)

Due to the occasional alpha particle emitted, from a polonium atom on the detector surface, at grazing incidence to the surface, there is always a small, low-energy tail to the peaks. This may be observed in the printed spectra. There is thus a spill of 214-Po counts from window C into window B. It is normally around 1% to 1.5% in a current production RAD7. The actual value is measured during the calibration process and the spill factor used to compensate for this phenomenon when measuring thoron in the presence of radon.

If the detector becomes contaminated in use, or either electronic or detector failure causes noise in the system, thus making the low-energy tail thicker, or the peaks broader, then this spill factor will increase.

The C Window to B Window spill factor value can be calculated from any reading, provided that it is known for sure that there was no thoron in the chamber. The percentage of counts in windows B and C is given in fields 10 and 11 of each record in memory (see Chapter 6.3.3). The spill factor is simply the ratio of the values in those two fields.

It is recommended that the C to B spill factor be noted every month. Any sudden change is cause for further study of the instrument, and an examination of the spectrum.

8 TROUBLESHOOTING

8.1 LCD Display

8.1.1 Blank Display

If the unit is switched on, the most likely cause of a blank display is discharged batteries. Please see Chapter 7.1.6.

Make sure the RAD7 is properly plugged in to an external power source and is switched on.

If the instrument has been run on the batteries and not recharged, or if it has been left untouched for a lengthy period, the batteries may be completely flat. In that case, the instrument should be left plugged in and switched on for many hours, preferably 24 hours or more. If this fails to restore the display, the RAD7 should be returned to DURRIDGE Company for service.

8.1.2 Frozen Display

If the display shows “DURRIDGE RAD7” and does not respond to key strokes, the keypad has been locked. Hold down the [ENTER] and two arrow keys until you hear a beep, release the three keys and immediately push [MENU]. You should then be rewarded by “Test” on the display. If the tone was set to OFF, then you will not hear the beep, so hold the three keys down for three to four seconds, before releasing them and pushing [MENU], - try hold-down times a little longer, or shorter, if at first you do not succeed. Please refer to Section 2.2.6.

8.1.3 Incomplete Or Garbage Characters

Incomplete or garbage characters may indicate a faulty LCD display. Please return RAD7 to DURRIDGE Company for service.

8.1.4 NVRAM Error

If the RAD7's LCD display shows “NVRAM Error – Contact DurrIDGE” when the RAD7 is powered on, something has gone awry in the instrument's nonvolatile memory or elsewhere in the digital communications circuitry. This can be

anything from gunky chip sockets, corrosion, a broken trace, problems with other chips, and so on. It is less common for the root of the problem to lie in the NVRAM itself.

It is likely that once an NVRAM error has appeared, it will keep appearing until the underlying problem with the circuitry is fixed.

It is usually impossible to tell which of the various possible causes of NVRAM errors is to blame without returning the RAD7 to DURRIDGE for service. Nevertheless we offer the choice of either:

- 1) Send the RAD7 back to DURRIDGE so that we can attempt to recover the data and then troubleshoot the problem.
- 2) Wipe the NVRAM without sending the RAD7 back to DURRIDGE, erasing any existing RAD7 data, to see if this solves the problem.

It is common for users to try option 2 first, and then, if necessary, option 1. Use the Left and Right arrow buttons on the RAD7's keypad to select whether to erase the memory, and then press [ENTER] to confirm the operation.

8.2 Readings

8.2.1 No Counts

The total number of counts so far in any cycle is displayed in the bottom righthand corner of Status Window 1. If, near the end of a cycle, there are no counts, or less than 10, say, it probably means the cycle length is too short. Increase the cycle length to increase the number of counts in a cycle and to improve the precision of the individual readings (>Setup Cycle, HH.MM [ENTER]).

If, with a cycle time of one hour or more, the total count near the end of a cycle continues to be zero and it is known that there is radon in the sample, then either the sample path is blocked or there is a fault with the RAD7 and it should be returned to DURRIDGE Company. Check that air is flowing using any of the following measures:

- a) Feel the air exiting the outlet when the pump is running.
- b) Stop the outlet of the RAD7 and feel the buildup of pressure.
- c) Clamp the sample input tubing, hear the change in pump sound and see the change in pump current (third status window).
- d) Feel the suction at the sampling point.

8.2.2 Excessive Uncertainty In Reading

If the uncertainty in the reading is greater than the base concentration value or if there is a large scatter in the readings, the cycle length is too short for the radon concentration being measured.

Increase the cycle time to reduce the scatter. Four times the cycle time will produce half the scatter and half the uncertainty. For past data, use CAPTURE to graph the data and use “Smoothing” to smooth out the statistical scatter in the data.

8.2.3 Run/Cycle Number 0000

A Run/Cycle number of 0000 indicates that the RAD7’s memory is full. Download the RAD7’s contents to a computer using CAPTURE. Then erase the RAD7 data using >Data Erase. The memory will be emptied and the data structure reset.

8.3 Relative Humidity high

Relative humidity (displayed in the third status window) normally starts high unless the instrument has been well purged just before starting the run. Depending on how long it has been since the last measurement, it may take an hour or more of measurement to bring the relative humidity down to below 10%.

If it takes too long to bring down the relative humidity, check the following:

- a) The desiccant is used up. Replace it.
- b) The desiccant insufficiently regenerated. Follow the instructions in Chapter 7.1.1.

- c) There is a leak in the drying unit. Clean the O-ring and seating before replacing the desiccant. Be sure to draw the air sample from the end furthest from the screw cap.
- d) There is a leak in the connection to RAD7.
- e) There is a blockage in the air path. Squeeze the inlet tubing and note any change in the sound of the pump. Feel for suction at the sampling point.

If none of the above succeed in lowering the relative humidity, there may be a problem with the humidity sensor. Measure the relative humidity of the air leaving the RAD7. If no humidity sensor is available, another RAD7, if one is available, would do. The two RAD7s can be connected in series. Set the downstream RAD7 pump to OFF (Setup, Pump, Off [ENTER]). If the downstream RAD7 reads a lower relative humidity than the upstream one, then the upstream humidity sensor is wrong and should be replaced. Return the RAD7 to DURRIDGE Company for service.

If none of these solutions are applicable, measurements made at high humidity can be corrected automatically using CAPTURE. See Chapter 3.12.2.

8.4 Water Catastrophe

If water ever enters the RAD7, or if the RAD7 ever goes swimming in the water, it will probably cease to operate and immediate steps should be taken to minimize the impact on the instrument. Keep the RAD7 upright. This will prevent water from touching the detector, which is close to the face plate at the top of the dome. Put a piece of tubing on the RAD7 outlet with the other end in a sink. Use the RAD7 pump if it still works or, otherwise, an external pump into the inlet, to blow air through the instrument. When water ceases to be blown out of the outlet, put desiccant upstream of the RAD7 to dry out the air path. When the air path is fully dry (after dry air has been blown through it for approximately one hour), remove the face plate from the case, empty the water out of the case and blow dry the case and the RAD7 electronics.

Once there is no visible water in or on the instrument, it can be put in an oven at 50°C for a

few hours to dry out completely. Additionally, desiccated air can be passed through the air path until the air leaving the RAD7 drops below 10% RH. After this treatment further corrosion will be prevented, and the RAD7 will boot once more and you can use the internal RH sensor to measure how dry the air path is. At this point the instrument should be returned to DURRIDGE for service.

8.5 Battery Voltage Low

Keep the RAD7 plugged into external power and switched on until the battery voltage (Status Window 3) recovers to about 7.1V. The RAD7 may safely be left charging all night.

8.6 Pathological Values and Error Messages

A Bad Offset Voltage error message, a >98% High Voltage Duty Cycle, or Leakage (L) above 15 (Status Window 4) all indicate faults in the RAD7, which should be returned to DURRIDGE Company without delay.

8.7 CAPTURE RAD7 Detection Failure

If DURRIDGE's CAPTURE software is unable to detect a connected RAD7, the following steps should be taken. Note that comprehensive instructions for troubleshooting a RAD7 detection failure and other CAPTURE problems can be found in the CAPTURE documentation available at the DURRIDGE website, and from the CAPTURE Help Menu.

1. Make sure you are using the latest version of CAPTURE. The software can be downloaded free of charge from the Durrige website.
2. Make sure your computer is running a supported operating system. The supported operating systems are listed in the System Requirements section of the CAPTURE documentation.
3. Make sure the RAD7 is powered On, and that the RAD7's battery is charged or charging.
4. Make sure the RAD7 is connected to the computer properly. If the computer has a built-in serial port, simply use a null modem cable (DB9 female to female). If a StarTech USB to serial adaptor cable is being used, connect the USB end of the adaptor cable to the computer, and the serial end of the cable to the RAD7. If a Keyspan USB to serial adaptor is being used, connect the adaptor to the computer and to the RAD7 using a USB-B cable and a null modem cable, respectively. Be aware that null modem cables have 9 holes at each end; standard serial cables are not supported, nor are gender changer adaptors that convert one end of a serial cable from male to female.
5. If you are using a serial to USB adaptor cable, it may be necessary to install driver software on your computer. Driver software for the adaptor that is included with the RAD7 is provided on the Durridge website, at www.durridge.com/software/software-drivers/.
6. Make sure the RAD7 has RADLINK installed. (To verify that it is installed, use the keypad to navigate to the >Special menu, and press [ENTER]. If >Special Ident appears, then RADLINK is installed correctly.) If RADLINK is not installed, use CAPTURE to install it. See the RADLINK Operations Section of the CAPTURE manual for detailed instructions. Note that it is possible to download data from a RAD7 that does not have RADLINK installed: use the Manual Download procedure described in the Basic CAPTURE Functionality section of the CAPTURE manual.
7. If the RAD7 is not detected when connected to a particular USB port, try connecting it to a different USB port on the computer.
8. Make sure your computer is not running anti-virus software or any program that could interfere with CAPTURE. This includes any other software that communicates using serial ports.
9. Using the RAD7's keypad, select >Special, SetBaud, [ENTER] to change its baud rate,

switching between 9600 and 19200.

Performing keypad commands such as this may help the RAD7 to "wake up".

10. Make sure the RAD7's baud rate is not set any lower than 1200. CAPTURE does not support baud rates of 300 or 600. The recommended baud rate is 9600.
11. After performing the above checks, if the RAD7 is still not recognized, try restarting the RAD7 and your computer. If another computer is available, try to connect on the other one.

Additionally, it can be helpful to determine whether the problem lies with the RAD7 or with the computer. This requires connecting a different serial device that is known to work, such as a modem or other instrument. Using a terminal emulation program such as Durrige Terminal or TerraTerm, attempt to communicate with the device. If communication is successful, then it is likely that there is a problem with the RAD7. If communication is unsuccessful, then it is more likely to be a problem with the computer.

Appendix 1: WIRELESS INFRARED PRINTER

A1.1 Infrared Printer Description

A1.1.1 General Printer Information

A portable wireless printer is provided as a standard accessory with the RAD7. It uses infrared technology to communicate with the instrument using the Infrared Data Association (IrDA) standard, or HP protocol.

The printer is designed around a patented easy-loading paper mechanism, which consists of a main cavity into which a paper roll is dropped for loading. The thermal print head is at the front of the cavity and a rubber roller is attached to the lid of the mechanism. When the lid is closed, the paper is pinched between the rubber roller and the print-head to give a close alignment and a consistent pressure.

A1.1.2 Printer Features

- Wireless printing
- IrDA standard or HP protocol
- Small size
- Quiet, and fast printing
- Direct line thermal printing
- Easy loading paper
- Easy maintenance and head cleaning
- User settable parameters using external buttons
- Self-test function

A1.1.3 Power Switch

The Power switch, located on the left side of the printer, is used to turn the unit ON and OFF.

A1.1.4 Indicator LEDs

The Power LED (Green) glows steadily when the printer is turned ON.

The Error LED (Red) flashes once-per-second when the printer is out of paper; the buffer is full; or when the print head temperature exceeds 140°F (60°C). This LED will also flash one time when the printer is placed into its set-up mode (refer to Section Set-Up Mode).

A1.1.5 Push Buttons

FEED Button:

Momentarily press the FEED button to advance the paper. Press and hold down to feed paper continuously.

This button in conjunction with the ON/OFF switch is used to start the printer's self test function (refer to the Self Test section).

When the printer is in its set-up mode, this button is used to modify the selected printer parameter (refer to the Set-Up Mode section).

SEL Button:

Used in conjunction with the ON/OFF switch to place the printer into its set-up mode (refer to the Set-Up Mode section).

With the printer in its set-up mode, use this button to select the desired printer parameter.

A1.1.6 Sensors

Paper Out: When the paper roll runs out, the printer is disabled to prevent damage to the print head. This condition is indicated by the Error LED flashing red.

Infrared Sensor: Located at the front of the printer, this sensor receives the infrared output of an external instrument.

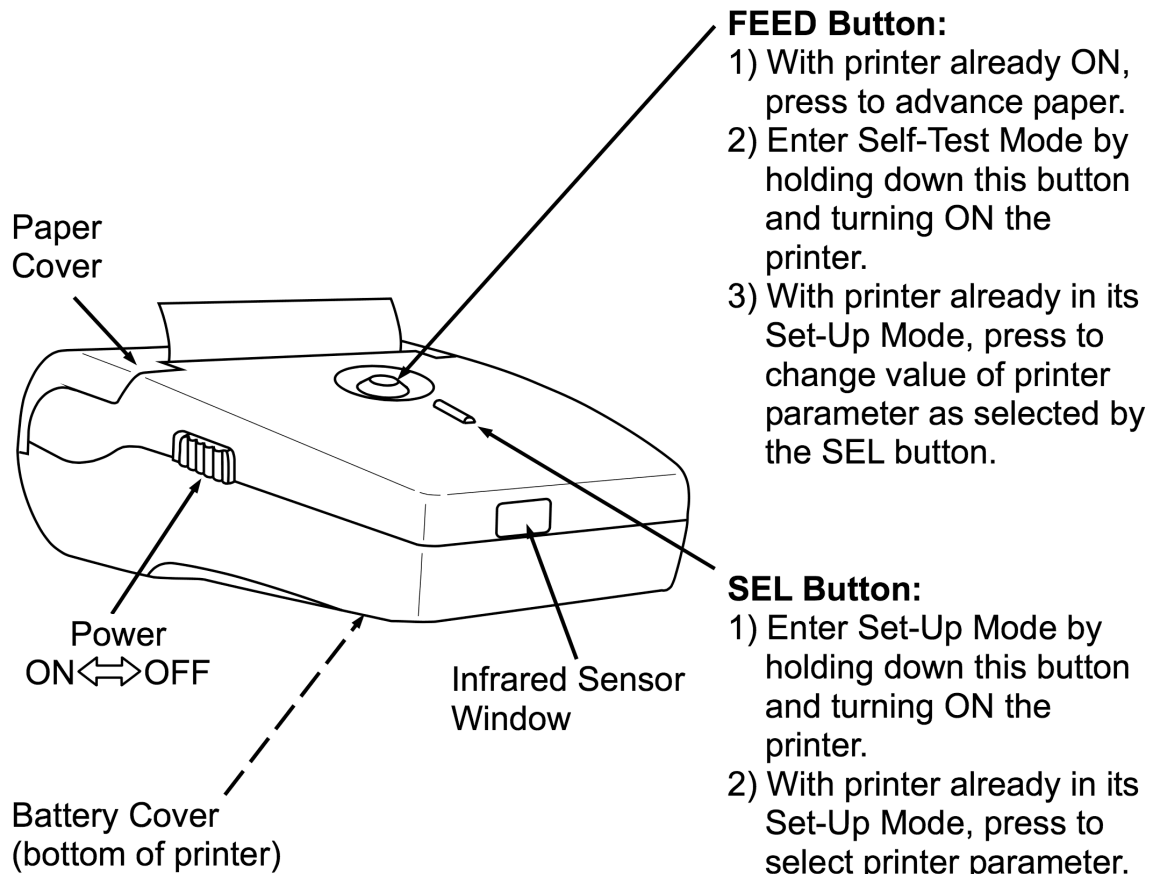

Top View of FEED Button

Power LED (Green):
Glow steady when printer is turned ON.

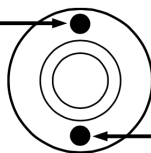

Error LED (Red):
Flashes once-per-second when paper is out; set-up mode is selected; buffer is full; or when print head temperature exceeds 140°F (60°C).

Infrared Printer Component Locations and Functions

A1.2 Infrared Printer Operation

A1.2.1 Precautions

To ensure the proper operation of the printer and prevent the possibility of voiding the warranty, be sure to observe the following precautions:

- Avoid dirty or dusty locations, or those with excessive heat or humidity
- Choose a stable level surface to place the printer
- Use only alkaline batteries
- Use only the appropriate thermal paper

A1.2.2 Self-Test

The self-test mode checks the printer's control circuit functions, setup parameters, software version, and printer quality.

Before running the self test, make sure there is sufficient paper to run the test (18" [46 cm]); the paper cover is closed; and that the printer is switched OFF.

With the printer initially switched OFF, press and hold down the FEED pushbutton, and then switch ON the printer to begin the test. Note: The test can be aborted by switching OFF the printer.

The following typical information is printed, followed by the printer's complete character set:

```
Version:      x.xx
Data bit:    8 bit
Parity:      None
Baud rate:   9600bps
Handshaking: DTR
Country:     U.S.A.
Print Mode:  Text (upright)
Paper:       Normal paper
Density:     100%
IrDA:        IrDA-SIR
Buffer Size: 7000Byte
Head volt:   6.0V
Head temp.:  25°C
```

A1.2.3 Setup Mode

The printer has been set up at the factory with the following default parameters:

```
Baud rate:  9600bps
Handshaking: DTR
Country:    U.S.A.
Print Mode: Text (upright)
Paper:      Normal paper
Density:    100%
IrDA:       IrDA-SIR
```

If necessary, the default parameters can be changed as follows:

1. With the printer initially switched OFF, press and hold down the SEL pushbutton; and then switch ON the printer.
2. The printer now goes into its set-up mode as indicated by the red LED flashing. At this time all of the printer's current parameter settings are printed, followed by the first parameter that can be modified.

Note that if no button is pressed within 15 seconds, the set-up mode is automatically terminated without changing the original parameters.

3. IrDA is the first parameter printed. Pressing the FEED button causes the value of that parameter to change in the sequence shown in the following table.

Table A1.2.3 Sel and Feed Functions

SEL Button	FEED Button
Baud Rate	300-115,200 bps
Handshaking	DTR, X-on/X-off
Country	U.S.A., Korea, Cyrillic, Denmark2, Norway, Japanese, Spain, Italy, Sweden, Denmark1, U.K., Germany, France
Print Mode	Text (upright), Data (inverted)
Paper	Normal Paper, Reprint Paper
Density	50-150% in 5% steps
IrDA	IrDA-Off, IrDA-SIR, HP-Ir

4. Press the SEL button to print the next parameter, and then use the FEED button to change that parameter to the desired value.
5. Repeat Step 4 as necessary to change all desired parameters.
6. Once all parameters have been set, press and hold down the SEL button, and then press the FEED button to save the new settings; after which the message “Data Keeping, Setting mode END !” should be printed.

A1.2.4 Using the Printer

Turn the printer ON and observe that the Power LED should glow green. Align the printer’s infrared sensor to the infrared output of the RAD7. The printer should not be more than 18 inches (45 cm) away from the instrument, at an angle of no more than 30 degrees. Issue a RAD7 command such as Data Print to initiate printing.

If the printer does not print, or if random characters are printed, check that the baud rate and communication protocol (IrDA-SIR or HP-Ir) settings of the printer is set to the correct value.

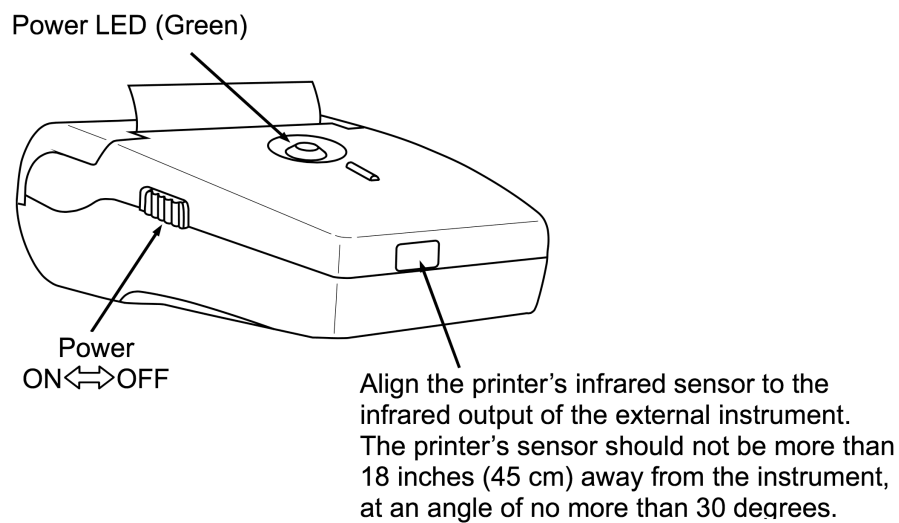

Using the Wireless Infrared Printer

A1.3 Infrared Printer Maintenance

A1.3.1 Battery Installation

The printer requires four AA alkaline batteries. To install or replace the batteries, first turn the printer OFF. Next, unlatch and remove the battery cover. Remove any old batteries and dispose of them properly. Then insert four new AA alkaline batteries, observing the polarity marked inside the battery compartment. Finally, replace the battery cover.

A1.3.2 Paper Installation

When the printer runs out of paper as indicated by the front panel red LED flashing, install a new paper roll as follows:

1. Lift up paper cover latch, and then open paper cover as illustrated on the following page.
2. Remove spent paper core and dispose it it.
3. Drop in a new paper roll so that it will rotate in the direction shown in the illustration.
4. Close the paper cover so that the paper is pinched between the roller and the print head. Remove any slack by pulling out about 1/2 inch of paper from printer.

Note: If there was unprinted data in the memory when the infrared printer runs out of paper, and the printer was not shut OFF, then the printer will

automatically print the remaining data 5 seconds after closing the paper cover.

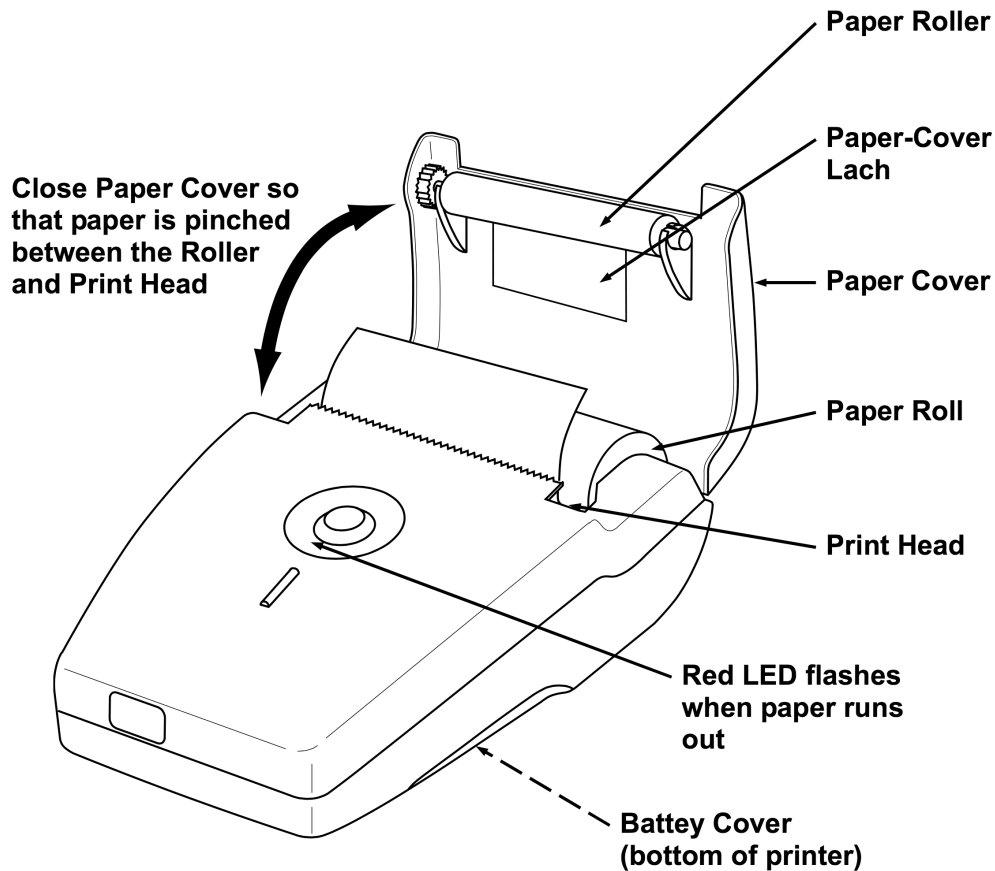

Wireless Infrared Printer Maintenance

A1.3.3 Cleaning the Printer

External surfaces of the printer may be kept clean by simply wiping with a damp cloth. Do not use any solvents that may attack the plastic case. Be sure that the inside surfaces are kept dry at all times.

A1.3.4 Cleaning the Print Head

To maintain a good print quality, it is recommended that the print head be cleaned at least once a year or up to once a month if the printer is used heavily. The print head should be cleaned immediately, however, if the print becomes visibly fainter due to contamination of the print head. The cleaning procedure requires

isopropyl alcohol and cotton swabs, and should be completed as follows:

1. Switch the printer OFF, and allow the print head to cool before cleaning, otherwise damage to the print head may occur.
2. Open the paper cover and remove paper roll.
3. Using a cotton swab dampened with alcohol, wipe the heating dots of the print head. Be careful not to touch the heating dots with your fingers.
4. Allow the alcohol to dry.
5. Reload the paper and close the paper cover.

A1.4 Wireless Infrared Printer Specifications

The following table contains the physical and technical specifications for the infrared printer.

Printing Method	Direct thermal
Number of Columns	32, 48 columns, 384 dots/line
Character Size	0.06 x 0.12 in. (1.5 x 3.0 mm)
Line Pitch	0.1 in (4.0 mm)
Paper Width	2.25 in. (57.5 mm)
Interface	IrDA and Serial (RS-232C)
Protocol	IrDA-SIR, HP-Ir, IrDA-Off
International Characters	U.S.A., France, U.K., Denmark, Sweden, Italy, Spain, Japan, Norway, Korea
Buffer	7 kB
Baud Rate	300-115,200 bps, IrDA: 9,600-115,200 bps
Power	4 AA Alkaline Batteries
Weight with batteries	0.8 lb. (0.4 kg)
Dimensions	3.2" W x 5.6" L x 1.6" H (81 x 142 x 41mm)

Table A1.4 Infrared Printer Specifications

Appendix 2: RAD7 Specifications

Specifications for the RAD7 exceed those of all radon gas monitors made in North America, as well as those in its price range world-wide. This is a partial list of specifications that make the RAD7 so highly regarded in the field.

Table A2.1 Functional Specifications

Modes of Operation	<ul style="list-style-type: none"> • SNIFF Rapid response and rapid recovery radon measurement • NORMAL High sensitivity radon measurement • AUTO Automatic switch from SNIFF to NORMAL after three hours • THORON Radon and thoron measured simultaneously and independently • GRAB Analysis of air “grabbed” from a discrete sample • WAT Automatic analysis of water samples with optional RAD H₂O accessory
Measurements	<ul style="list-style-type: none"> • Radon in air measurement with Sniff protocol for quick, spot reading • Thoron protocol for searching for radon entry points • Radon in air 1-day, 2-day or weeks protocol for long term measurement • Radon in water samples with optional RAD H₂O and Big Bottle RAD H₂O kits • Continuous radon in water testing with optional RAD AQUA and Water Probe • Radon in soil gas with optional Soil Gas Probe and DRYSTIK • Radon emission from soil and hard surfaces with optional accessory • Bulk radon emission from bulk materials and objects with optional accessory
Data Storage	1,000 records, each with 23 fields of data Log of printer output also stored
Sample Pumping	Built-in pump draws sample from chosen sampling point Flow rate typically 800 mL/min
Print Output	Short, Medium, or Long format data printed after each cycle Run summary printed at end of run, including averages and spectrum
PC Connectivity	RS232 serial port, full remote control implemented in CAPTURE Software Optional serial to Bluetooth adaptor for wireless PC connectivity
Audio Output	<ul style="list-style-type: none"> • GEIGER Tone beeps for radon and thoron counts • CHIME Chime only at the end of each cycle, otherwise silent • OFF No sound
Tamper Resistance	TEST LOCK command locks keypad to secure against tampering

Table A2.2 Technical Specifications

Principle of Operation	Electrostatic collection of alpha-emitters with spectral analysis Passivated Ion-implanted Planar Silicon detector SNIFF mode counts polonium-218 decays NORMAL mode counts both polonium 218 and polonium 214 decays
Built-In Air Pump	Nominal 1L/min flow rate Inlet and outlet Luer connectors
Connectivity	RS-232 port up to 19,200 baud rate USB adaptor is included with every RAD7
Measurement Accuracy	+/-5% absolute accuracy, 0% - 100% RH
Nominal Sensitivity	SNIFF mode, 0.25 cpm/(pCi/L), 0.0067 cpm/(Bq/m ³) NORMAL mode, 0.5 cpm/(pCi/L), 0.013 cpm/(Bq/m ³)

Radon Concentration Range	0.1 - 20,000 pCi/L (4.0 - 750,000 Bq/m ³)
Intrinsic Background	0.005 pCi/L (0.2 Bq/m ³) or less, for the life of the instrument
Recovery Time	Residual activity in Sniff mode drops by factor of 1,000 in 30 minutes
Operating Ranges	Temperature: 32° - 113°F (0° - 45°C) Humidity: 0% - 100%, non-condensing
Cycle Range	User controllable number of cycles, from 1 to 99 to unlimited, per run User controllable cycle time, from 2 minutes to 24 hours
CAPTURE Software	<ul style="list-style-type: none"> • Compatible with Microsoft Windows 7 through 10, and macOS • Automatic RAD7 connection and data download • Graphs radon, thoron, temperature and humidity over time • Automatic humidity correction • Statistical analysis tools track concentration averages and uncertainties • Chart Recorder mode provides real-time RAD7 status monitoring • Control RAD7 operations from computer via direct or remote connection • Automatic calculation and display of radon in water with optional accessories • Automatic combination of data from multiple RAD7s

Table A2.3 Physical Specifications

Dimensions	11.5" x 8.5" x 11" (29.5 cm x 21.5 cm x 27.9 cm)
Weight	9.6 pounds (4.35 kg)
LCD Display Output	2 line x 16 character, alpha-numeric display
Case Material	High density polyethylene
Infrared Printer	Omniprint OM1000 Wireless Infrared Printer included
Power Supply	11-15V DC (12V nominal) @ 1.25A, center pin positive, or included internal EnerSys sealed lead acid rechargeable battery pack (6V nominal, 30Wh, 5Ah)
Battery Longevity	24 hours in SNIFF mode; 72 hours in Monitor mode

DURRIDGE Company Inc.
900 Technology Park Drive
Billerica, MA 01821

Telephone: (+1) 978-667-9556
Fax: (+1) 978-667-9557
Web: www.durridge.com
Email: service@durridge.com

© Copyright 2021 DURRIDGE Company Inc. All rights reserved.

DURRIDGE, the DURRIDGE logo, and the Works with the DURRIDGE logo are trademarks of DURRIDGE Company Inc., registered in the U.S.

Note: DURRIDGE frequently updates its product manuals with new information. The latest version of this manual can be downloaded in PDF format from the following location: www.durridge.com/support/product-manuals/

Revision 2021-06-22