



FALCO 1.1

Instrument User Manual V1.1R



Register
your instrument
online to receive
your extended
warranty.

Unrivalled Gas Detection.

ionscience.com

Thank you for purchasing your Ion Science instrument.







Register your instrument online for the warranty



The standard warranty of your FALCO 1.1 VOC Monitor is for one year.

To receive the warranty, you must register your instrument online within one month of purchase (terms and conditions apply).

Visit ionscience.com/instrument-registration

Contents

EXD Certification FTZÚ	4
EXD Certification QPS	5
Declaration of conformity	6
Statements	7
Validity of this Manual	7
Responsibility for Correct Use.....	7
Warnings	7
Quality Assurance.....	7
Disposal	7
Legal Notice.....	7
Warranty	7
Service	7
Contact details.....	8
Introduction to FALCO	9
Technical Specification	9
Un-Packing	11
System Description	12
Outputs and Communications	12
RS485 Modbus Interface	13
Installation Requirements	14
Location Requirements	14
Power Requirements.....	14
Cable and Gland Requirements.....	14
Installation	15
Preparation for Installation	15
Dimensions for Installation	15
To Install the Housing Module	16
After-Installation Test	16
Installation in Zones with Explosive Atmospheres.....	17
Configurations of the Current Loop	18
Removal of the Control Module	19
To Remove the Control Module.....	19
Operating the FALCO	20
User Interface.....	20
Start-Up Routine	21
Normal Running Mode Screen	21
Software Screens.....	22
Menu i1	23
Menu i2	23
Menu i3	24
Menu i4	24
Menu i5	24
Menu i6	24
Calibration	26
RF (Response Factor) 	28
Detection Units 	28
PID Duty Cycle 	29
Pump Duty Cycle 	29
Alarms.....	29
Alarm Brightness 	30
Alarm Pulsing 	30
Relays	31
4 – 20 mA.....	31
Modbus Address 	32

Status Light Brightness 	32
Service Mode 	32
Password Lock 	33
Servicing		34
Cleaning the MiniPID.....		34
Replacing the PTFE Filter Disc		36
Fault Diagnostics		37
Alarm and Fault Indications		37
Fault Conditions		37
Spare Parts		38
Manual Log		40

Symbols



WARNING!

USED TO INDICATE DANGER WARNINGS WHERE THERE IS A RISK OF INJURY OR DEATH.



WARNING! - DANGER OF ELECTRIC SHOCK

USED TO INDICATE DANGER WARNINGS WHERE THERE IS A RISK OF INJURY OR DEATH FROM ELECTRIC SHOCK.



CAUTION

USED TO INDICATE A CAUTION WHERE THERE IS A RISK OF DAMAGE TO EQUIPMENT.



PROHIBITED ACTION

USED TO INDICATE ACTIONS THAT ARE NOT PERMITTED; E.G. 'YOU MUST NEVER'.



INFORMATION

IMPORTANT INFORMATION OR USEFUL HINTS ABOUT USAGE.

Recycling and Disposal



RECYCLING

RECYCLE ALL PACKAGING.



WEEE REGULATIONS

ENSURE THAT WASTE ELECTRICAL EQUIPMENT IS DISPOSED OF CORRECTLY.

EXD Certification FTZÚ

**Physical Technical Testing Institute
Ostrava – Radvanice**

**EC-Type Examination Certificate**

- (1)
(2) **Equipment or Protective Systems Intended for Use
in Potentially Explosive Atmospheres
(Directive 94/9/EC)**

(3) EC-Type Examination Certificate Number:

FTZÚ 15 ATEX 0113X

- (4) Equipment: **VOC analyzer type FALCO 1.1; FALCO 1.2**
- (5) Manufacturer: **Ion Science Ltd.**
- (6) Address: **The Way, Fowlmere, Cambs, SG8 7UJ, Great Britain**
- (7) This equipment or protective system and any of acceptable variation thereto is specified in the schedule to this certificate and the documents therein referred to.
- (8) The Physical Technical Testing Institute, notified body number 1026 in accordance with Article 9 of the Council Directive 94/9/EC of 23 March 1994, certifies that this equipment or protective system has been found to comply with the Essential Health and Safety Requirements relating to the design and construction of equipment and protective systems intended for use in potentially explosive atmospheres given in Annex II to the Directive.
- The examination and test results are recorded in confidential Report N°:
- 15/0113 dated 18.01.2016**
- (9) Compliance with Essential Health and Safety Requirements has been assured by compliance with:
EN 60079-0:2012, EN 60079-1:2007, EN 60079-11:2012
- (10) If the sign "X" is placed after the certificate number, it indicates that the equipment or protective system is subject to special conditions for safe use specified in the schedule to this certificate.
- (11) This EC-Type Examination Certificate relates only to the design, examination and testing of the specified equipment or protective system in accordance to the Directive 94/9/EC. Further requirements of the Directive apply to the manufacturing process and supply of this equipment or protective system. These are not covered by this certificate.
- (12) The marking of the equipment or protective system shall include the following:

Ex II 2G Ex d ib IIC T4 Gb

This EC-Type Examination Certificate is valid till: **07.01.2021**

Responsible person:

Lukáš Martinák
Dipl. Ing. Lukáš Martinák
Head of Certification Body



Date of issue: 18.01.2016

Page: 1/3

This certificate is granted subject to the general conditions of the FTZÚ, s.p.
This certificate may only be reproduced in its entirety and without any change, schedule included.

FTZÚ, s.p., Pikartská 1337/7, 716 07 Ostrava-Radvanice, Czech Republic,
tel +420 595 223 111, fax +420 596 232 672, ftzu@ftzu.cz, www.ftzu.cz

EXD Certification QPS



QPS Evaluation Services Inc
Testing, Certification and Field Evaluation Body
Accredited in Canada, the USA, and Internationally

File
LR1355

CERTIFICATE OF COMPLIANCE (ISO TYPE 3 CERTIFICATION SYSTEM)	
Issued to	Ion Science Ltd.
Address	The Way, Flowmere Cambridge UK SG87 UJ
Project Number	LR1355-2
Applicant	Elok-Opava, spol. s r.o.
Address	Sadek 17, 747 75 Velké Heraltice Czech Republic
Product	VOC Analyser without pump and VOC Analyser with pump
Model Number	FALCO 1.1 without pump and FALCO 1.2 with pump
Ratings	Input Voltage: 8-40VDC from SELV Class I, Zone 1 AEx d ib IICT4 Class I, Div 1 Groups ABCD T4 T _{Amb} = -40°C to +50°C FALCO 1.1 or -20°C to +50°C FALCO 1.
Applicable Standards	CAN/CSA C22.2 No. 60079-0, 2015.10.01 Third edition CAN/CSA C22.2 No. 60079-1, 2016.01.01 Third edition CAN/CSA C22.2 No. 60079-11, 2015 Third edition CAN/CSA C22.2 No. 61010-1, 2012 Third edition CAN/CSA C22.2 No. 30-M1986 (R2016) UL 60079-0 (2013.07.26) Sixth Edition UL 60079-1 (2015.09.18) Seventh Edition UL 60079-11 2013.02.15) Sixth Edition UL 61010-1 Third edition UL 1203 2013 Fifth Edition
Factory/Manufacturing Location	Same As applicant
<p>Statement of Compliance: The product(s) identified in this Certificate and described in the Report covered under the above referenced project number have been investigated and found to be in compliance with the relevant requirements of the above referenced standard(s). As such, they are eligible to bear the QPS Certification Mark shown below, in accordance with the provisions of QPS's Service Agreement.</p>	
<p>Issued By: Dave Adams, P. Eng. Manager, Hazardous Locations Dept. [Ex Equipment]</p>	
Signature:	Date: May 16, 2017

81 Kelfield St., Units 7-9, Toronto, ON M9W 5A3 Tel: 416-241-8857; Fax: 416-241-0682
 www.qps.ca

QSD 34

Rev 04

Declaration of conformity

EU DECLARATION OF CONFORMITY

According to Decisions No 768/2008/ES of the European Parliament and of the Council
VOC Analyser Type Falco 1.1, Falco 1.2

The manufacturer stated below declares that the characteristics of the product meet the required technical standards, directives and specifications and that it conforms to the respective European Union harmonisation standards. Furthermore the manufacturer declares the product to be safe whilst adhering to the conditions for its correct installation, maintenance and use. This declaration of conformity is issued under the sole responsibility of the manufacturer.

Manufacturer:

Ion Science Ltd, The Hive, Butts Lane, Fowlmere, UK, SG8 7SL

Notification of quality assurance:

FTZU 02 ATEX Q 025

Product description:

The FALCO unit is a fixed monitor for the continual monitoring and measuring of VOCs in the atmosphere.

Authorised person:

FTZU, AO 210, OSTRAVA-RADVANICE, IN - 00577880

Notified person

CE 1026

Certificate number:

FTZU 15 AREX 0113X

Type of protection:

 II 2G Ex d ib IIC T4 Gb

Conformity assessment procedure:

The product's conformity was assessed with respect to the following requirements:

- ATEX Directive 2014/34/EU, EMC Directive 2014/30/EU
- It was compared with the submitted documentation
- Issued on fundamentals of declaration of conformity of the producer
- It was tested to according standards

List of standards:

EN 55022:2010, EN 60079-0:2012, EN 60079-1:2007, EN 60079-11:2012, EN 61000-4-11:2004, EN 61000-4-3:2006, EN 61000-4-4:2012, EN 61000-4-5:2014

List of technical regulations:

02607,NKO

Date and Place of issue: Authorised representative:

12. 09. 2016 Mark Stockdale



Ion Science Ltd, The Way
Fowlmere, SG8 7U

Created by: Andrew Scott

Created on: 12 Sept 2016

Doc. No / Rev.: AS 02 27-07-2017

Approval by: Graham Davies

Approved on: 27 July 2017

State: Released

Ion Science Ltd

ionscience.com

Statements

Validity of this Manual

This User Manual gives information and procedures for the firmware version shown on the front page of this manual. If you have different versions of firmware, please obtain the correct User Manual.

Responsibility for Correct Use

Ion Science Ltd accepts no responsibility for incorrect adjustments that cause harm or damage to persons or property. The users are responsible to respond appropriately to the readings and alarms given by FALCO.

Use the equipment in accordance with this manual, and in compliance with local safety standards.

Reduced performance of gas detection might not be obvious, so equipment must be inspected and maintained regularly. Ion Science recommends:

- you use a schedule of regular checks to ensure it performs within calibration limits, and that
- you keep a record of calibration check data.

Warnings

1. Read and understand this Manual fully before you install or operate the FALCO.
2. For safety, the FALCO must only be operated by qualified personnel.
3. Substitution of components can result in unsafe conditions and will invalidate the warranty.
4. Surface mount fuses must only be replaced by Ion Science service centres.

Quality Assurance

The FALCO is manufactured in compliance with ISO9001:2008. That ensures that the equipment is:

- designed and assembled reproducibly, from traceable components,
- calibrated to the stated standards before it leaves our factory.

Disposal

Dispose of FALCO and its components in accordance with all local and national safety and environmental requirements. This includes the European WEEE (Waste Electrical and Electronic Equipment) directive. Ion Science Ltd offers a take-back service. Please contact us for more information.

Legal Notice

Whilst every attempt is made to ensure the accuracy of the information contained in this manual, Ion Science accepts no liability for errors or omissions, or any consequences deriving from the use of information contained herein. It is provided "as is" and without any representation, term, condition or warranty of any kind, either expressed or implied. To the extent permitted by law, Ion Science shall not be liable to any person or entity for any loss or damage which may arise from the use of this manual. We reserve the right at any time and without any notice to remove, amend or vary any of the content which appears herein.

Warranty

To receive your 2 Year Warranty, you must register within one month of purchase (Terms and Conditions apply). You will then receive a confirmation email that your Warranty Period has been activated and processed.

Full details, along with a copy of our Warranty Statement can be found by visiting: <http://ionscience.com/customer-support/instrument-registration>

Service

Ion Science recommends a twelve-month service replacement of the MiniPID sensor lamp.

Contact Ion Science or your local distributor for service options in your area.

Contact details

UK Head Office

Ion Science Ltd
The Hive, Butts Lane,
Fowlmere,
Cambridge,
SG8 7SL
UNITED KINGDOM

Tel: +44 (0)1763 207206
Fax: +44 (0) 1763 208814
Email: info@ionscience.com
Web: ionscience.com

USA Corporate HQ

Ion Science Inc
4153 Bluebonnet Drive
Stafford
TX 77477
USA

Tel: +1 (877) 864 7710
Email: info@ionscienceusa.com
Web: ionscienceusa.com

German Office

Ion Science Messtechnik GMBH
Laubach 30
Metmann-Neandertal
40822
GERMANY

Tel: +49 2104 14480
Fax: +49 2104 144825
Email: info@ism-d.de
Web: ism-d.de

Italian Office

Ion Science Italia
Via Emilia 51/c
40011 Anzola Emilia
Bologna
ITALY

Tel: +39 051 0561850
Fax: +39 051 0561851
Email: info@ionscience.it
Web: ionscience.it

Introduction to FALCO

The FALCO unit is a fixed detector for the continual monitoring and measuring of volatile organic compounds (VOCs) in the atmosphere. VOCs can be dangerous as they are poisonous to humans and there is a risk of explosion. VOCs are detectable using photo ionisation detection (PID) detector.

The FALCO's multi coloured LED status display screen can be seen from a distance of twenty metres in direct sunlight ensuring that personnel are alerted to hazards present.

The FALCO has five magnetic switches with LED confirmation, a high contrast OLED screen, and graphical interface ensuring quick and easy installation and servicing.

The magnetic switches are operated with a magnetic actuator that provides the actions of up, down, left, right and enter.

The main display uses organic light emitting diode (OLED) technology and the status bar uses light emitting diodes (LED). It also has a galvanically separated 4-20ma current loop, Modbus (serial communication protocol) and two configurable switched contacts.

For protection in explosive areas the FALCO's Main Unit electronics are fitted in a flameproof enclosure and the PID Sensor Head is intrinsically safe.

The FALCO has two modules:

- The **Main Unit** (flameproof enclosure)
- The **PID Sensor Head** (intrinsically safe)

The externally located intrinsically safe PID Sensor Head allows servicing and calibration in a hazardous environment without having to isolate the power supply.

Technical Specification

Name	VOC Analyser Falco 1.1
Dimensions	h 205 mm, w 180 mm, d 125 mm
Weight	2.9 kg
Nominal Voltage	8V to 40Vdc (Powered from Safety Extra-Low (SELV))
Maximum Current	0.56A at 12V / 6.6W 0.28A at 24V / 6.7W 0.2A at 40V / 8W
Typical Power	2W (depending on the LED intensity)
Supply Cables	0.5 to 2.5mm ²
Maximum Contact Load	60Vdc / 2A 50Vac / 2A
Internal Voltage 4-20mA	19V ± 1V / 1 70mA
Fuse	Fuse T 1A (blow value 35A)
Protection	II 2G Ex d ib IIC T4 Gb
Operating Temperature:	-40°C to + 50°C
Operating Humidity:	0 – 100 RH% (condensing)
Storage Temperature	-40°C to +60 °C
Ingress Protection	Main Unit: IP65 Sensor Head: IP65
PID Sensor	MiniPID II 1G Ex ia IIC T4 (-40 °C ≤ Ta ≤ +60 °C) Baseefa07ATEX0060U
Measuring Range	0 to 10ppm, 0 to 50ppm, 0 to 1,000ppm, 0 to 3,000ppm

T90	< 30 seconds (when set to continuous monitoring)
Accuracy	+/- 5 % at calibration point
Measuring Interval	1 s to 10 min
Display Screen	OLED 64x128 pixels
WEEE Compliant	Compliant with the European Waste Electrical and Electronic Equipment directive

Un-Packing

All equipment shipped by Ion Science Ltd is packed in containers with shock absorbing filling to protect them against physical damage.

Remove the contents carefully and check them against the packing list. Report discrepancies between the contents and the packing list to Ion Science Ltd. Ion Science will not be responsible for discrepancies not reported within ten days of your receipt of the shipment.

Every FALCO (new units and those returned from a Service Centre) must have a Certificate of Calibration before you install it.

System Description

Outputs and Communications

FALCO has six communication outputs:

- The on-board LCD and LEDs on the faceplate.
- 4-20mA Current Loop.
- RS485 Modbus.
- Two programmable relays.

This real-time information is displayed on the LCD and transmitted on the 4-20mA and RS485 channels.

You can program two alarms to operate at a chosen concentration of gas. The alarms will display a message on the LEDs, energise the relays, and transmit a signal on the 4-20mA channel.

The alarms and relays are individually programmable to the settings required by the site policy. You can choose either alarm to energise either relay.

Both relays can be programed to switch 60VDC / 2A or 50VAC / 2A maximum load.

RS485 Modbus Interface

The FALCO Modbus interface uses Modbus RTU

- 9600 baud, 8 data bits, no parity, 1 stop bit.

Register Address	Name	Function Code	Data Type	Range	Register Qty
102	Gas concentration	3 - Read Holding Registers	32-bit Float	±1.175494E-38 to ±3.402823E+38	2
106	Sensor Voltage(mV)	3 - Read Holding Registers	32-bit Float	±1.175494E-38 to ±3.402823E+38	2
108	Temperature (°C)	3 - Read Holding Registers	16-bit Signed Integer	-32768 to +32767	1
182	LED Brightness	3 - Read Holding Registers	16-bit unsigned Integer	0 to 100	1
1003	Hardware Version	3 - Read Holding Registers	16-bit unsigned Integer	1 to 255 (Default value 1)	1
1005	Measurement Unit	3 - Read Holding Registers	Character	'p' or 'g' (Default value 'p')	1
1010	Response Factor	3 - Read Holding Registers	32-bit Float	0.1 - 10.00	2
1012	Sensor Range	3 - Read Holding Registers	16-bit unsigned Integer	10, 50, 1000, 3000 (Default value 3000)	1
1060	Cal 100	3 - Read Holding Registers	16-bit unsigned Integer	0 to 65535 (Default value 500)	1
1061	Cal3000	3 - Read Holding Registers	16-bit unsigned Integer	0 to 65535 (Default value 3000)	1

Installation Requirements

Please make sure you understand all the installation requirements and have read the technical specification before you install FALCO.

Location Requirements

There are many variables involved in defining the optimum location for a gas detector.

Mount the FALCO:

- in a location where it is most likely to detect the gas.
- in an area that has good air circulation. Restricting natural air current can result in delayed detection.
- on a solid, stable support, where it is accessible for servicing.
- in a vertical position, with the sensor at the bottom to help avoid rain and dust entering the sensor chamber.
- not in direct sunlight or over a heat source (this can cause the Falco to exceed its certified internal working temperature of 50°C).
- not in areas likely to flood.
- In a location that is easy access for servicing.



INFORMATION

- If the VOCs being detected are known to be lighter than air install the FALCO unit as high on the wall as is practical.
- If the VOCs being detected are known to be heavier than air then install the FALCO unit as low as possible but never on the floor.

Power Requirements

Nominal Voltage: 12V to 40Vdc

Cable and Gland Requirements

We recommend you use screened cables e.g., multicore cable with SWA armour, or Braid Armour to protect against EMI.

The manufacture and build of the cable glands is the responsibility of the installer. The cable glands must conform to the certification standards required for the installation site. Install blanking plugs with the appropriate certification standards to unused cable gland ports.

The external terminal is to be used to ground / earth the Falco instrument. The connecting wire must be a minimum of 4mm².

Installation



INFORMATION

Before installing the FALCO unit thoroughly read the technical specification contained in this User Manual

Preparation for Installation

Before you install the FALCO, refer to the:

- Instrument User Manual
- Location Requirements ([Location Requirements](#))
- Power Requirements ([Power Requirements](#))
- Cable and Gland Requirements ([Cable and Gland Requirements](#))
- Dimensions for Installation (See below)
- RS485 Interface Requirements ([RS485 Modbus Interface](#))

Dimensions for Installation

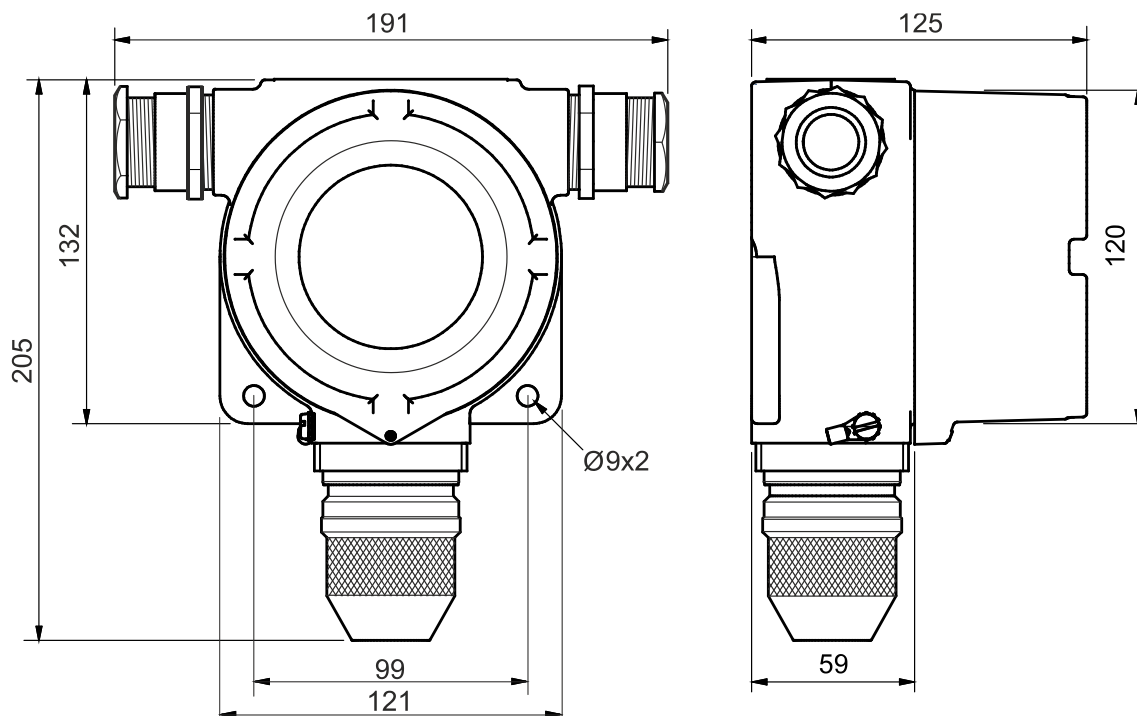

To Install the Housing Module

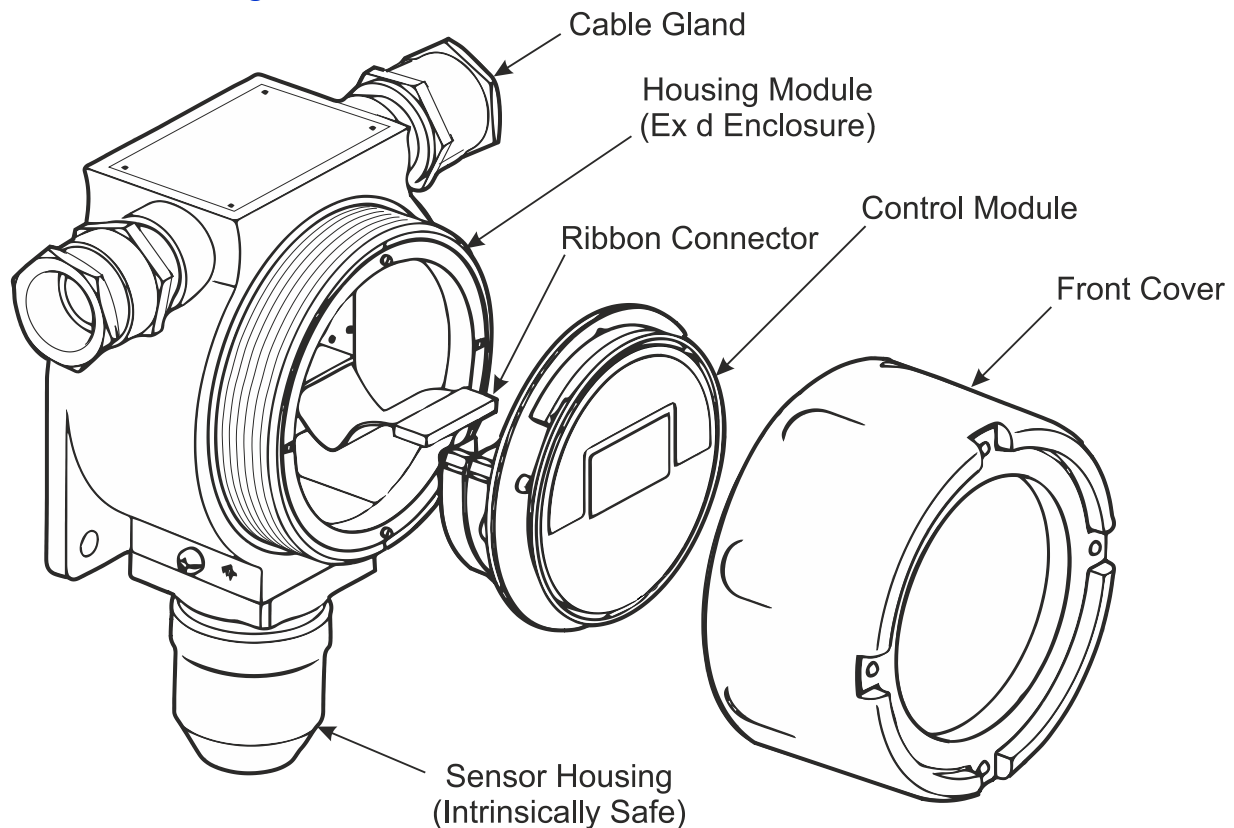

To install the FALCO as a complete assembly

1. Use two M8 screws to install the FALCO as a complete unit (Main Unit and Sensor Housing together) on a solid, stable support.
2. After you install the FALCO, unscrew and remove the Front Cover and disconnect the Control Module from its Ribbon Connector to get access to the terminal blocks.
3. Install the cable glands. Feed the cables through the glands and make the connections to the terminal blocks as you require. Refer to Configurations of the current loop, on the following pages.
4. Seal the cables in the cable glands.
5. Reconnect the Control Module to the Ribbon Connector and place into position.
6. Screw the Front Cover back on.
7. Connect and switch on, the power supply.
8. Do an After-Installation Test. Refer to [After-Installation Test](#).

After-Installation Test

Do a test of the relay and the 4-20mA systems to check for correct installation and function.

Do a "Bump Test" to verify that the sensors respond correctly to the Benzene gas at the concentrations programmed for Set Points 1 and 2.

A "Bump Test" does not calibrate the sensors. If the instrument does not display the gas concentration given by the bottle, do a calibration to give the correct readings.

Installation in Zones with Explosive Atmospheres

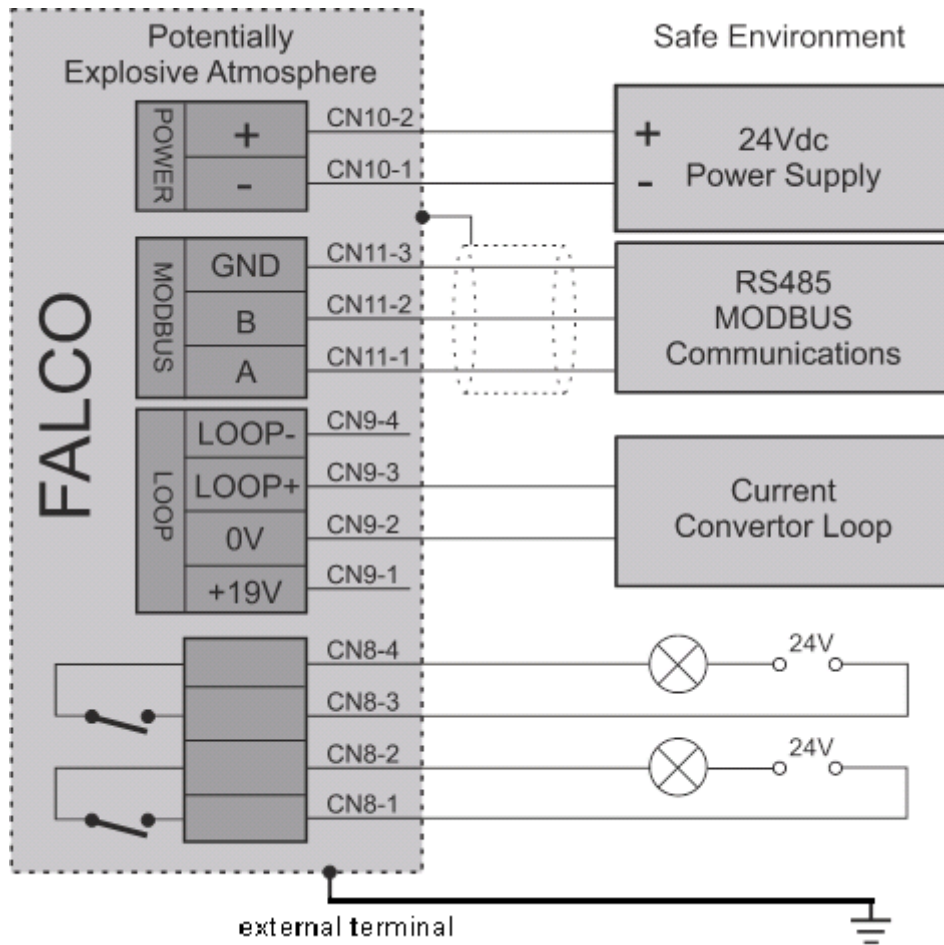

Example method of connection for explosive environment

Configurations of the Current Loop

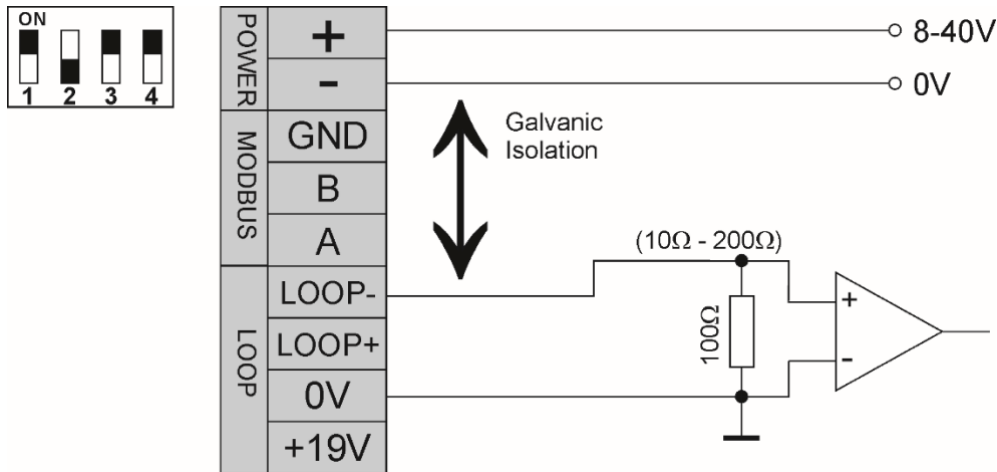

Galvanically separated current loop – active - preferred connection

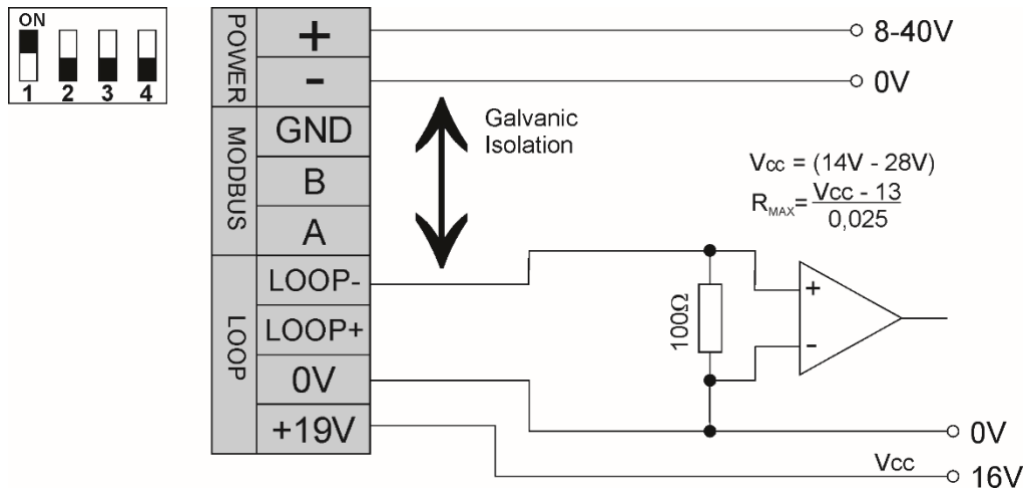

Galvanically separated current loop – passive

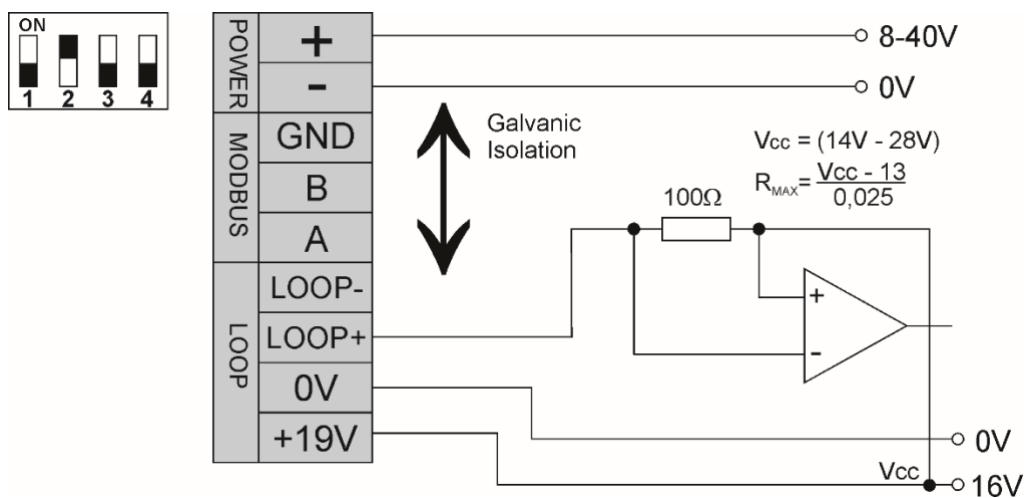

Galvanically separated current loop – active

Removal of the Control Module

The removal of the Control Module will only be necessary if the module is no longer required in its detecting position or if there is a module malfunction. The FALCO has an externally located intrinsically safe sensor, allowing for quick and easy servicing without the need for a hot work permit. Dual certification allows the FALCO to be serviced and calibrated in a hazardous environment without having to remove the power.

To Remove the Control Module

Caution – This area must be known to be free of flammable concentrations prior opening the enclosure

To remove the FALCO as a complete assembly:

1. Switch off and isolate the power to the FALCO.
2. Unscrew and remove the Front Cover.
3. Disconnect the Control Module from the Ribbon Connector and remove it.
4. Unseal the cables in the cable glands.
5. Disconnect the cables from the terminal blocks and withdraw them from the Housing Module via the cable glands.
6. Make sure that all the electrical connection are either removed or left in a safe, isolated condition.

Operating the FALCO

User Interface



The FALCO front face has:

- OLED display,
- Keypad - 5 magnetic keys,
- Status Light

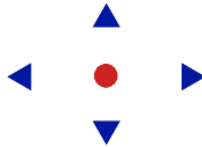
Keypad





For easy menu navigation the keypad consists of five magnetic keys **Up**, **Down**, **Left**, **Right** and **Enter**.

- | | | |
|-----------------------|---|---|
| Up and Down |  | Moves the cursor (indicating which screen option is currently selected) and adjusts numeric values and settings up and down. |
| Left and Right |  | Moves the cursor left and right and steps between menu screens.
Left is also used to “escape” settings screens (e.g. exit a menu or sub-menu). |
| Enter |  | Used to enter features (e.g. settings screens) and to confirm specified settings. |





INFORMATION

The Enter  key, and the Left  key when being used to escape, must be pressed and held briefly to operate them.

The other keys, and the Left key when not been used for escape only need to be tapped.

Status Light

- | | |
|--------|---|
| Yellow | Displayed during start-up only, when power is first applied. |
| Green | Indicates that FALCO is operating correctly.
Also displayed during the start-up routine. |
| Amber | Flashing amber indicates Alarm 1  has been triggered i.e. the measured level of VOC is above the alarm threshold.
Also displayed during the start-up routine. |
| Red | Flashing red indicates Alarm 2  has been triggered, i.e. the measured level of VOC is above the alarm threshold.
Also displayed during the start-up routine. |



INFORMATION

The % brightness of the LEDs during normal operation and when alarms are being triggered is configurable.

There are separate settings for both conditions.

Start-Up Routine

When power is applied, the Status Light goes yellow.

The FALCO will then display the following screens, in this order:

Logo screen



After the power is turned on, the FALCO displays the 'Ion Science' logo for 3 seconds and the status light is green.

Info screen 1

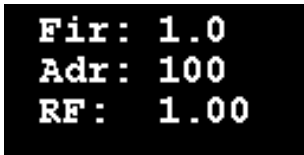

Info screen 1 then appears for 3 seconds. It displays the following:

- Fir - Firmware version
- Adr - Modbus address
- RF - Response factor

The status light goes amber.

Info screen 2

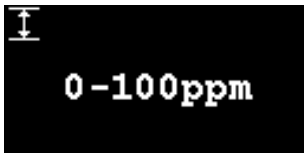

The Info screen 2 then appears for 3 seconds showing the measurement range. The status light goes red.

Warm up



The Warm up screen then appears and the screen shows the 30 minute countdown. The status light goes green.



INFORMATION

After switch-on the instrument should be allowed to acclimatise for 30 minutes before working in its 'Normal running mode'.

The warm-up time can be skipped by pressing the **Enter**  key.

Normal Running Mode Screen



The screen then appears continuously and shows the PID reading and units. The Status Light colour depends on the status.



INFORMATION

The hour glass symbol will appear on the screen for the remaining 'warm-up' time if it has been skipped. The brightness of the display will also slowly pulsate to indicate that the warm up period has been skipped.

Software Screens

There are six menus: **i1**, **i2**, **i3**, **i4**, **i5** and **i6**.

Software Flow Chart

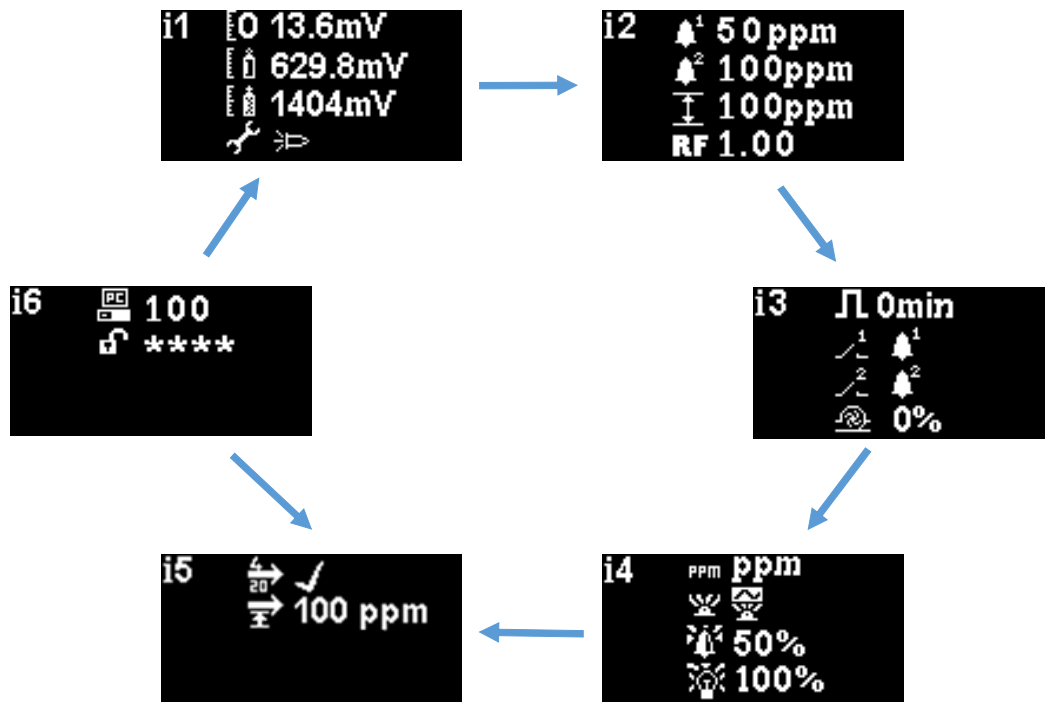

To access the settings menus, press the **Right** key from the Normal Running Mode screen. If a passcode has been set, the Lock screen will be displayed. Otherwise, the **i1** menu will be displayed.

Lock Screen



The Lock screen is displayed if a password number has been specified (see menu **i6**). It protects the instrument from unauthorised adjustment - the menus (see below), cannot be accessed until the correct number has been entered.

Press the **Enter** key. A cursor is then displayed under the first asterisk. Press the **Up** or **Down** key. The asterisk will be replaced by a number. Keep pressing the up and down keys until the first digit of the passcode is displayed.

Press the **Right** key to move to the next asterisk. Repeat the above procedure to enter the next digit. Repeat until the four digits of the password are entered.

Press the **Enter** key. If the correct password was entered, the **i1** menu will be displayed.

If not, the LED status indicator will change to red. The Lock screen remains displayed, and the user can attempt to enter the password again.





INFORMATION



Entering 4321 at the Lock screen will always enable access to the menus. This can be used if, for example, the actual password has been forgotten.

Navigating the Menus and Selecting Menu Options

The six screens are navigated through using the left and right keys on the magnetic keypad. For example, if the **i2** menu is being displayed, press the left key to display the **i1** menu and the right key to display the **i3** menu.

Each of the menu screens has two or more options on it.

To activate the menus press the **Enter**  key. A  cursor is then displayed next to the first option in the current menu.

To select a menu option, use the **Up**  and **Down**  keys to move the cursor to the required option. To enter the required option, press the **Enter**  key.

See below for details of all the menus, sub-menus and options.



INFORMATION

If no action is taken in the menu screens for 120 seconds, the display will automatically revert to the Normal Running Mode screen. If a passcode has been set, this must again be entered to access the menus.

Menu i1



This menu displays following options, along with their current settings:



Zero: Used to set the Zero gas calibration level. The currently set level (in mV) is displayed.



Span 1: Used to set the Span 1 gas calibration level. The currently set level (in mV) is displayed.



Span 2: Used to set the Span 2 gas calibration level. The currently set level (in mV) is displayed.



Service mode: Used to switch to the miniPID sensor in and out of servicing mode. When service mode is selected the power to the minPID is turned off. The current setting is indicated by a symbol.



indicates the miniPID is off,  indicates the miniPID is on.

Menu i2



Alarm level 1: Used to set the ppm level at which Alarm 1 is triggered. The current level is displayed.



Alarm level 2: Used to set the ppm level at which Alarm 2 is triggered. The current level is displayed.



Measurement range: Used to view the detection range of the instrument.



Response factor: Used to set the response factor appropriate for the gas to be detected. The current factor is displayed.

Menu i3 



Pulse duration: This duty cycle be used to extend the life of PID sensor lamp. It can set set to switch off for 1 to 10 minutes between readings. The current duration setting is displayed.



Relay 1 output: The instrument has two relay outputs, both of which can be triggered by a condition selected by the user. The condition that triggers Relay 1 is selected via the **Relay 1 output** option. A symbol representing the currently selected trigger condition is displayed (see the Relay section for more infomration).



Relay 2 output: See above.



Pump duty cycle: Not relevant to this instrument. The FALCO.1.1 is not equipped with a pump.

Menu i4 



Detection units: Used to change the detection units from the default of ppm to mg/m³. The current units are displayed.



PID status light mode: Used to switch the status light between steady illumination and slow pulsing when alarming. The current setting is indicated by a symbol.



Alarm brightness: Used to set the brightness of the status light during alarm conditions.



Status Light brightness: Used to set the brightness of the status light during normal operation.

Menu i5 

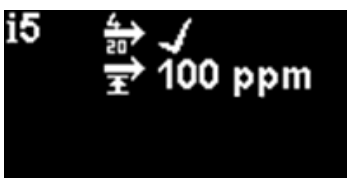

4mA Enable/Disable: Used to set the 4mA to 20mA output to be active or inactive, as indicated by a tick or a cross.



20mA range: Used to set the 20mA range of the instrument.

Menu i6 







Modbus address – Used to select a Modbus slave address.



Password lock – Used to set the password lock on and off, and to change the password number.

The symbol for this option indicates whether the lock is on  or off .

Calibration

The calibration options are accessed from Menu i1



INFORMATION

0 – 10 and 0 – 50 ppm Falco require 2 point calibration (Zero and Span1). 0 – 1000 and 0 – 3000 ppm Falco require 3 point calibration (Zero, Span 1 and Span 2).

For best performance it is recommend to use gas concentrations similar to the alarm levels set.

Before started the calibration process please ensure you have the following equipment ready for use.



Magnetic Actuator (part no. 873202)

Calibration Adaptor Only use the calibration adaptor supplied with the Falco. It regulates the pressure of gas delivered to the sensor (part no. 873201)

Zero air or N₂

Span gas



Zero



- 1) Local ambient air can be used for zeroing as long as it can be confirmed there are no target or interferences gases present in concentrations exceed the lower detection limit of the Falco. If this cannot be confirmed a zero air or N₂ cylinder should be used. If using a cylinder attach the calibration adaptor to the sensor housing and open.
- 2) Enter zero cal mode by moving the cursor to the zero cal icon  and then press the **Enter**  key. The zero cal screen is described below:



The top value is the live ppm reading from the Falco (based on previous calibration)



The bottom number indicates this is the zero cal screen

- 3) The live reading will move towards zero as the sensor housing is purged. When the reading is stable press the **Enter**  key to set the zero level.
The Status Light will then blink briefly to confirm the setting has been made. The top reading will then change to 0.0ppm.
- 4) Remove the calibration adaptor if applicable (if conducting a span calibration leave it on).
- 5) Press the  button to exit zero mode.

Note: The cursor cannot be moved from next to the “set” symbol . The only function the user can carry out is to press the **Enter**  key to set the zero level to the current ppm reading.

Span 1



Span 1 is used to calibrate Span 1 of the Falco.



- 1) Attach the calibration adaptor to the sensor housing.
- 2) Enter Span 1 mode by moving the cursor to the Span 1 icon  and then press the **Enter**  key. The Span 1 screen is described below:





The top value is the live ppm reading from the Falco (based on previous calibration)

The lower value is the span 1 concentration (100.7ppm in this example).

- 3) If the Span 1 concentration is not the same as the calibration gas concentration it must be changed. To change the Span 1 concentration move the cursor  to the lower value and press the **Enter**  key. A new screen with that value is then displayed.

Change this value to match the level specified on the calibration gas bottle as follows. A cursor  is displayed under the first digit of the value. Press the **Up**  or **Down**  key to change it.



Press the **Right**  key to move to the next digit. Repeat the above procedure to change it as required.

Press the **Enter**  key to return to the previous screen (above). Then move the cursor to the "set" symbol  and apply the gas to the PID sensor. When the live reading stabilises press the **Enter**  key. The status light will 'blink' briefly to confirm the setting has been changed.

- 4) Remove the calibration adaptor (if not performing a span 2).
- 5) Press the  button to exit span 1 mode.
- 6) If the sensor fails to clear to less than 10% after 3 minutes check the sensor housing is sealed against the miniPID sensor.

Span 2



Span 2 is used to calibrate span 2 of the Falco.



- 1) Attach the calibration adaptor to the sensor housing.
- 2) Enter span 2 mode by moving the cursor to the span 2 icon  and then press the **Enter**  key. The span 2 screen is described below:





The top value is the live ppm reading from the Falco (based on previous calibration)

The lower value is the span 2 concentration (10005 ppm in this example).

- 3) If the span 2 concentration is not the same as the calibration gas concentration it must be changed. To change the span 2 concentration move the cursor  to the lower value and press the **Enter**  key. A new screen with that value is then displayed.

Change this value to match the level specified on the calibration gas bottle as follows. A cursor  is displayed under the first digit of the value. Press the **Up**  or **Down**  key to change it.

Press the **Right**  key to move to the next digit. Repeat the above procedure to change it as required.

Press the **Enter**  key to return to the previous screen (above). Then move the cursor to the “set” symbol  and apply the gas to the PID sensor. When the live reading stabilises press the **Enter**  key. The status light will ‘blink’ briefly to confirm the setting has been changed.

- 4) Remove the calibration adaptor.
- 5) Press the  button to exit Span 2 mode.
- 6) If the sensor fails to clear to less than 10% after 3 minutes check the sensor housing is sealed against the miniPID sensor.

RF (Response Factor)

Response factor adjustment is accessed from Menu i2



PIDs are typically calibrated with isobutylene. However, not all VOCs have the same response. The difference in response can be accounted for by multiplying the reading by the VOC's response factor. If a response factor is applied the concentration displayed on the Falco will represent the concentration of the VOC.

For example, if the RF is 00.50, and 100ppm is detected based on an isobutylene calibration:

$$100 \text{ ppm} \times 00.50 = 50 \text{ ppm is the value displayed}$$

The default setting for the response factor is 1.

To set a response factor move the cursor to the response factor icon  and press the **Enter**  key.

A cursor  is displayed under the first digit of the value. Press the **Up**  or **Down**  key to change it.



Set the response factor by moving the cursor and changing the values.



If a factor of higher than 10.00 is entered, when the **Enter**  key is pressed, the factor will revert to the default (01.00ppm) and the screen will not exit.

The Modbus will output the calculated value. The 4-20 mA output will not.

The factor can be adjusted from 0.100 to 10.00 in 0.01 increments.

Detection Units

The detection unit options are accessed from Menu i2

Move the cursor  to the required units. Press the **Enter**  key to save the setting change and return to the i2 menu. The status light will then blink briefly to confirm the setting has been made.

Press the **Esc**  key to return to the i4 menu without saving the change to the setting.



Used to change the detection units from the default of ppm to milligrams per meter cubed (mg/m^3).

The default units are 'ppm' and there is an option to display the readings in milligrams per meter cubed (mg/m^3). To display the reading in mg/m^3 requires a barometric pressure and temperature value. The instrument assumes the fixed values shown below.

Barometric pressure: 1000 mBar

Temperature: 20 °C

PID Duty Cycle

PID duty cycle is accessed from menu i3



The PID duty cycle can be set from continuous to 10 minutes with 1 minute increments

The default setting is 00 minutes, meaning that the PID will not switch off. This setting is adjustable in 1 minute increments:

00 mins = PID is illuminated permanently. Outputs updated 1/second.

01 mins = PID is switched off between measurements. Outputs updated 1/minute.

02 mins = PID is switched off between measurements. Outputs updated 2/minute.

03 mins = PID is switched off between measurements. Outputs updated 3/minute.

...and so on for the 04 mins to 10 mins settings.

Pump Duty Cycle

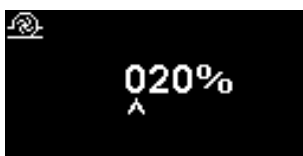

This is not relevant on Falco 1.1 as it does not have a pump.

Not relevant to this instrument. The FALCO.1.1 is not equipped with a pump.

Alarms



The alarm levels are set in menu i2

The Falco has 2 alarms levels, 1 and 2. When alarm level 1 is reached the status bar will go amber and Alarm 2 is reached the status bar will go red.

Alarm 1



Used to set the ppm level at which Alarm 1 (amber) is triggered. When accessed, the screen displays the current level.

Set the level as follows. A cursor  is displayed under the first digit of the alarm level. Press the **Up**  or **Down**  key to change it.

Press the **Right**  key to move to the next digit. Repeat the above procedure to change it as required. Repeat until the required value has been entered.

Press the **Enter**  key to save the setting change and return to the **i2** menu. The status light will then blink briefly to confirm the setting has been made.

Note that the instrument will not allow the Alarm 1 level to be set above the Alarm 2 level.

Press the **Esc**  key to return to the **i2** menu without saving the change to the setting.

Alarm 2



Used to set the ppm level at which Alarm 2 (red) is triggered. When accessed, the screen displays the current level.

Set the Alarm 2 level in the same way as described for Alarm 1 above.

Note that the instrument will not allow the Alarm 2 level to be set below the Alarm 1 level.

Alarm 1 will be superseded by the Alarm 2, i.e. if the level of organic compound detected exceeds the Alarm 2 level, that alarm will be triggered instead of Alarm 1 (even though the level will be above the Alarm 1 threshold as well).

Alarm Brightness

Alarm brightness is accessed from menu i4



Used to set the brightness of the Status Light during alarm conditions, from 0 to 100%, or to AUTO mode.

Change the percentage brightness as required.

Alarm brightness may also be set to AUTO mode. Auto mode will measure the ambient light on the face of the instrument and adjust the brightness of the LED's. The LED's will become brighter if the instrument is in high LUX conditions (bright sunshine) and dimmer at night time.

While in the screen, the Status Light will change to red, and will change brightness in response to change to brightness percentage.



If a brightness of higher than 100% is entered, when the **Enter**  key is pressed, the factor will revert to the default (100%) and the screen will not exit

Alarm Pulsing

PID duty cycle is accessed from menu i3



Used to switch the LED display between steady illumination and slow pulsing

To change the setting, press the **Up**  or **Down**  key to change the setting. The symbol will change as appropriate:



Steady illumination.



Slow pulsing.

Press the **Enter** key to save the setting change and return to the **i3** menu.

Press the **Esc** key to return to the **i3** menu without saving the change to the setting.

Relays

Relay options are accessed from menu i3

Relay 1 Options



Used to specify which of 4 conditions will trigger the Relay 1 output. Each is represented by a symbol, as described below.

The following conditions may be selected from:



Activate when Alarm 1 is exceeded.



Activate when Alarm 2 is exceeded.



Activate when a fault condition is raised.



Activate for 1 second after the output is updated.

To change the setting, press the **Up** or **Down** key to browse through the 4 settings. The symbol will change as appropriate.

Press the **Enter** key to save the setting change and return to the **i3** menu.

Press the **Esc** key to return to the **i3** menu without saving the change to the setting.

Relay 2 Options



Used to specify which of 4 conditions will trigger the Relay 2 output.

See the description of the Relay 1 options setting for details.

4 – 20 mA

4 – 20 mA options are accessed from menu i5

4 – 20 mA Enable/Disable



Used to turn the 4mA to 20mA output on and off.

To change the setting, press the **Up** or **Down** key to switch between on (tick symbol), and off (cross symbol).

Press the **Enter** key to save the setting change and return to the **i5** menu.

Press the **Esc** key to return to the **i5** menu without saving the change to the setting.

4 - 20mA Range 

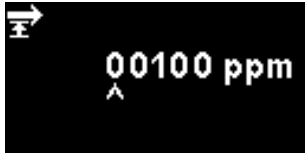

The lower limit of the 4mA to 20mA output range, mapped to 4mA, is 0ppm. This option is used to set the upper limit, mapped to 20mA.

Change the value as required.

Modbus Address 

Modbus address setting is accessed from menu i5



Used to select a Modbus slave address.

Change the address number as required, from 1 to 247. The instrument default is address 100.

A unique slave address must be assigned for each Modbus slave device on your network.

Status Light Brightness 

The Status Light brightness is accessed in menu i4

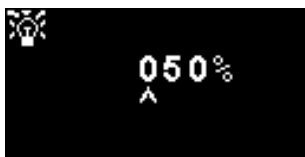

Used to set the brightness of the Status Light during normal operation, from 0 to 100%, or to AUTO mode.

Change the percentage brightness as required.

Status light brightness may also be set to AUTO mode. Auto mode will measure the ambient light on the face of the instrument and adjust the brightness of the LED's. The LED's will become brighter if the instrument is in high LUX conditions (bright sunshine) and dimmer at night time.

While in the screen, the Status Light will change to green (if it wasn't already), and will change brightness in response to change to brightness percentage.

If a brightness of higher than 100% is entered, when the **Enter**  key is pressed, the factor will revert to the default (100%) and the screen will not exit.

Service Mode 

Service mode is accessed from menu i1



Used to turn the service mode for the MiniPID sensor on and off.

The power supplied to the MiniPID sensor is not dangerous to the user by either the risk of electrocution or cause a threat of an explosion in a hazardous environment.

It is however good practice to remove local power to circuitry when servicing to avoid possible damage by short circuit.

A service mode setting for the setting that removes local power is therefore available, and can be switched to and from using this screen.

The lamp symbol on the screen indicates whether or not the sensor service mode is on or off.

If the sensor is in normal mode  is displayed.

If the sensor is in servicing mode  is displayed.

To change the setting, press the **Up** ▲ or **Down** ▼ key. The symbol will change as appropriate. Press the **Up** ▲ or **Down** ▼ key again to reverse the setting.

Press the **Enter** ● key to save the setting change and return to the **i1** menu.

Press the **Esc** ◀ key to return to the **i1** menu without saving the change to the setting.

See below for how to change these settings.



INFORMATION

Alarm levels can be used to trigger relay 1 or relay 2 (see relay section above).

Password Lock



Used to set the password lock on and off, and to change the password number.

The current password number will be displayed on the screen. The default value is 0000, which sets the lock to “off”.

Change the password number as required. Use the same method for changing numbers as described previously for the Alarm1 setting.

Changing the number to any number apart from 0000 will set the lock to “on”, with that number as the required password.

Change the password number back to 0000 to turn the lock off again.

Servicing

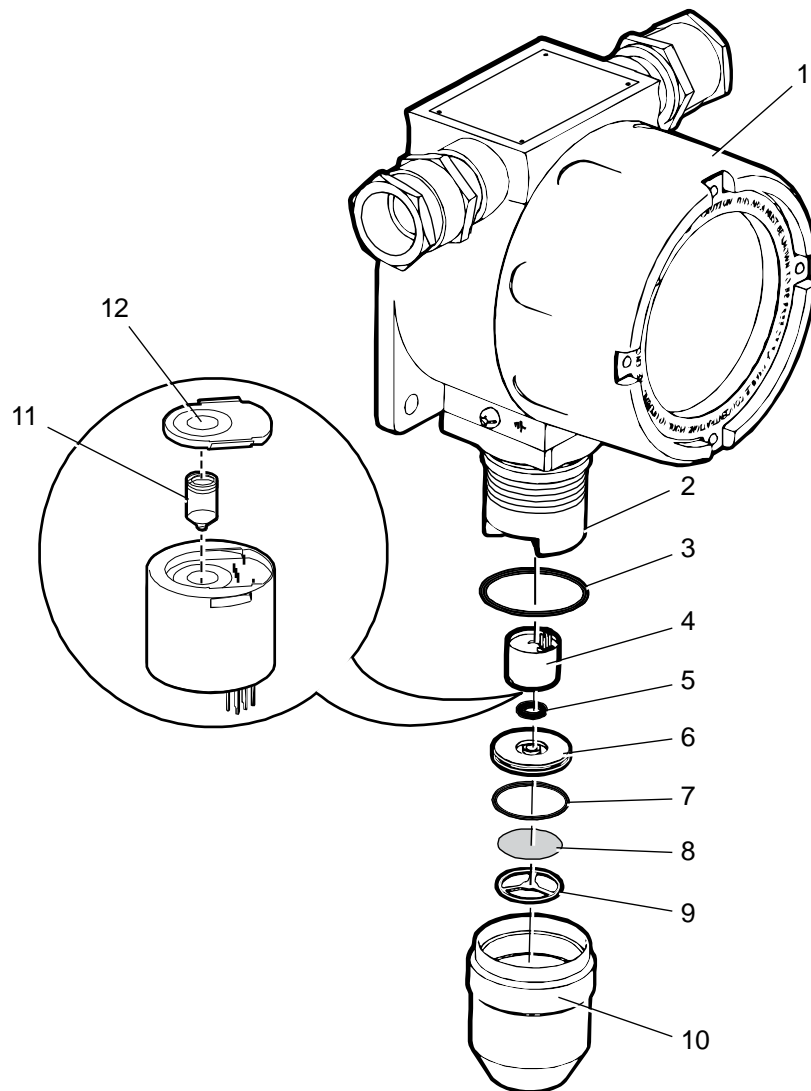

Cleaning the MiniPID

FALCO has been designed to ensure servicing is quick and easy:

1. Before servicing FALCO, set the device to Servicing Mode.
2. Unscrew the Sensor Cover (10) to access the MiniPID (4) located in the Sensor Housing (2).
3. Remove the MiniPID (4) by carefully withdrawing it, without twisting from the Sensor Housing (2). Only light force is required.



CAUTION

Do not twist the MiniPID (4) while it is within the Sensor Housing (2).

4. Use the electrode stack removal tool to remove the electrode stack. Hold the MiniPID (4) upside down, the Electrode Stack (12) and PID Lamp (11) can then be removed.



CAUTION

Ensure the Electrode Stack (12) and PID Lamp (11) falls onto a soft surface such as a piece of tissue. This will avoid damaging the parts as they fall out and avoids finger contact with the PID Lamp window.

5. Clean the PID Lamp (11) using the PID lamp cleaning kit (A-31063) **To clean the PID Lamp (11):**

- Open the vial of Aluminium Oxide polishing compound. With a clean cotton bud collect a small amount of compound.
- Use this cotton bud to polish the PID Lamp window. Use a circular action applying light pressure to clean the lamp window. Never touch the lamp window with fingers.
- Continue polishing until an audible “squeaking” is made by the cotton bud with compound moving over the window surface (usually within fifteen seconds).
- Remove the residual powder with short blast of air from the can of air duster.



INFORMATION



Contamination of the PID Lamp window can considerably reduce the detection capability of the MiniPID (4), even when the contamination is not visible. Cleaning of the lamp should be carried out on a regular basis depending on the duty cycle of the PID Lamp (11) and the environment.

The humidity of the air and contaminants may affect the time required between servicing.

6. The Electrode Stack (12) should be inspected for visible signs of contamination, if contamination can be seen the Electrode Stack (12) must be replaced.

Reassembly

7. Place the clean PID Lamp (11) into the MiniPID (4) avoiding finger contact with the Window.
8. Refit the Electrode Stack (12) with the electrical pin holes and electrode contacts facing down.
9. Refit the electrode stack.
10. Ensure the electronic pins of the MiniPID (4) are at the 12 o'clock position before inserting the MiniPID (4) back into the Sensor Housing (2). The MiniPID (4) should insert into the connectors easily, if significant resistance is felt, remove the cell and check alignment before reinserting.
11. The Flaco must be calibrated



CAUTION

Irreparable damage will be caused by forcing the MiniPID (4) into the Sensor Housing (2) if not correctly aligned.



INFORMATION

Always calibrate the FALCO after servicing is carried out.

Use of PID Lamp Cleaning Kit A-31063

The container of cleaning compound contains Aluminium Oxide as a very fine power (CAS Number 1344-28-1).

The Compound has a TVL (TWA) of 10 mg/m³ and a full material safety data sheet MSDS is available on request from Ion Science Ltd. The key issues are listed below:

Hazard identification:

May cause irritation of respiratory tract and eyes.

Handling:

- Do not breathe the vapour/dust
- Avoid contact with skin, eyes and clothing
- Wear suitable protective clothing
- Follow industrial hygiene practices;
Wash face and hands thoroughly with soap and water after use and before eating, drinking, smoking or applying cosmetics

- Always replace the lid after using the cleaning compound.

Storage:

Keep container closed to prevent water adsorption and contamination.

Replacing the PTFE Filter Disc

1. The removed Sensor Cover (**10**) contains 'O' Ring Holder (**6**), PTFE Filter Disc (**8**) and Light Guard (**9**). To remove the PTFE Filter Disc (**8**) from the Sensor Cover (**10**) carefully push onto the centre of the Light Guard (**9**) until the 'O' Ring Holder (**6**) and PTFE Filter Disc (**8**) are free from the Sensor Cover (**10**).
2. Check the 'O' Rings (**5** and **7**) on the 'O' Ring Holder (**6**) for possible damage and replace if required. Discard the PTFE Filter Disc (**8**) to be replaced with a new one.
3. Push back into position the Light Guard (**9**), reposition the new PTFE Filter Disc (**8**) and push in the assembled 'O' Ring Holder (**6**) until it sits against the Light Guard (**9**).
4. Check the 'O' Ring (**3**) on the Sensor Housing (**2**) and replace if required.
5. The assembled Sensor Cover (**10**) can now be screwed back tightly onto the Sensor Housing (**2**).
6. The FALCO MUST now be re-calibrated.

Fault Diagnostics

Alarm and Fault Indications



Activated when Alarm 1 is exceeded.



Activated when Alarm 2 is exceeded.



Activated when a fault condition is raised.







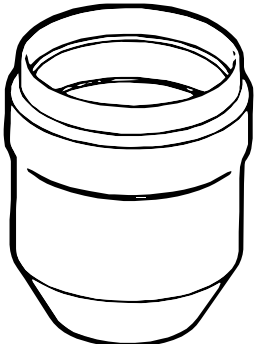

Fault Conditions

The FALCO is equipped with a number of diagnostics to ensure instrument faults are detected and communicated. The table gives a fuller description of each fault and lists some possible causes and corrective actions you can try.

If the fault continues, or is repeated, contact your Service Centre.

Displayed Fault Screen	Fault Description	Corrective Action
	If the user has exited the initial 30 minute warm up phase, this screen will be displayed for 7 seconds until the lamp has struck.	Wait until the lamp has struck and the instrument displays a reading. If the lamp does not strike replace it.
	The present gas concentration has 'over-ranged' the instrument. The instrument can display readings greater than 19999 (3000ppm) or 1999.9 (1000ppm) or 199.99 (50ppm) or 19.999 (10ppm).	Wait until gas concentration returns to lower levels and the instrument reading reappears.
	The lamp is not lit during a measurement cycle or PID is not installed.	Replace Lamp or insert PID
	The analogue to digital converter has stopped working.	Contact Service Centre.
	There is a external light in the sensor. The Falco can't recognize if the lamp is shining.	Screw the Sensor Cover

Spare Parts

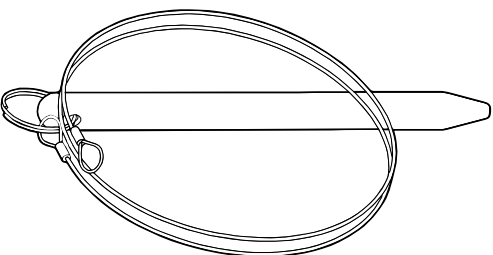
Item No	Part	Part Number	Description
10		873206	Sensor Cover
9		873207	Light Guard
3		873209	O-Ring (large fits outer edge of O-Ring Holder)
5		873208	O-Ring (small fits into face of O-Ring Holder)
8		873210	PTFE Filter Disc
6		873211	O-Ring Holder
4		MP6SM6F WXU2 or MP6SM6FO XU2	MiniPID
11		875292	MiniPID Lamp 10.6eV
12		See below	Electrode Stack
			Magnetic Actuator
	Removal Tool MiniPID Stack – Used to remove Stack / Pellet from the MiniPID Sensor	846216	Electrode stack (pellet) removal tool

Item No	Part	Part Number	Description
12	50 and 3000 ppm electrode stack	A-846629	Orange electrode stack with seal
12	10 and 1000 ppm electrode stack	A-846627	White electrode stack with seal
	PID Lamp Cleaning Kit- Contains Alumina powder and 40 cotton buds	A-31063	Lamp Cleaning Kit
	Calibration Adaptor	873201	Calibration Adaptor

Manual Log

Manual Version	Amendment	Issue Date	Instrument Firmware	PC Software
1.0	First Issue	27/09/2016	1.0	n/a
1.1	Addition of US cert – page 5 Declaration of conformity – page 6 LED/OLED statement – page 9 Information – P33 Addition of disclaimer – page 40	26/07/2017	1.1	n/a
1.1R	Logo only	31/07/17	1.1	n/a

Disclaimer: Information in this [manual, document...] is subject to change without notice and does not represent a commitment on the part of Ion Science. No claims, promises or guarantees are made about the accuracy, completeness, or adequacy of the information contained herein.