

GLS **SAMPLER**

Installation and Operation Guide



Part #69-2953-031
Copyright © 1998. All rights reserved, Teledyne Isco, Inc.
Revision T, April 21, 2011

Foreword

This instruction manual is designed to help you gain a thorough understanding of the operation of the equipment. Teledyne Isco recommends that you read this manual completely before placing the equipment in service.

Although Teledyne Isco designs reliability into all equipment, there is always the possibility of a malfunction. This manual may help in diagnosing and repairing the malfunction.

If the problem persists, call or e-mail the Teledyne Isco Technical Service Department for assistance. Simple difficulties can often be diagnosed over the phone.

If it is necessary to return the equipment to the factory for service, please follow the shipping instructions provided by the Customer Service Department, including the use of the **Return Authorization Number** specified. **Be sure to include a note describing the malfunction.** This will aid in the prompt repair and return of the equipment.

Teledyne Isco welcomes suggestions that would improve the information presented in this manual or enhance the operation of the equipment itself.

Teledyne Isco is continually improving its products and reserves the right to change product specifications, replacement parts, schematics, and instructions without notice.

Contact Information

Customer Service

Phone: (800) 228-4373 (USA, Canada, Mexico)
(402) 464-0231 (Outside North America)
Fax: (402) 465-3022
Email: IscoCSR@teledyne.com

Technical Support

Phone: (800) 775-2965 (Analytical)
(866) 298-6174 (Samplers and Flow Meters)
Email: IscoService@teledyne.com

Return equipment to: 4700 Superior Street, Lincoln, NE 68504-1398

Other Correspondence

Mail to: P.O. Box 82531, Lincoln, NE 68501-2531
Email: IscoInfo@teledyne.com
Web site: www.isco.com

Safety Summary

The Isco GLS Portable Sampler is a “definite purpose” device, intended for use only with compatible Isco equipment. Do not use this product with any other manufacturers’ equipment, or for any other purpose. Use for any purpose not described in this manual could cause personal injury or property damage.

Electrical Requirements

The GLS requires 12 V^{DC} at 3.75 amperes. The input is through the two-pin military type connector on the side of the controller. An internal 3.75 ampere PTC (Positive Temperature Coefficient) protects the internal circuitry.

Safety Symbols and Hazard Alerts

The icons found within this instruction manual alert the user of known hazards. The icons are described below.

The instruction manual identifies the hazardous condition and any steps necessary to correct the condition. The manual presents this information in one of two ways:

 CAUTION
--

Caution identifies a potential hazard, which if not avoided, may result in minor or moderate injury. This category can also warn you of unsafe practices or conditions that may cause property damage.

 WARNING
--

Warning identifies a potentially hazardous situation, which if not avoided, could result in serious injury or death.

GLS Compact Sampler

Table of Contents

Section 1 Introduction

1.1 About this Manual	1-1
1.1.1 Identifying GLS Components	1-2
1.1.2 Compatible Equipment	1-2
1.1.3 Typical Applications	1-2
1.2 Radio Interference Statement	1-3
1.3 Technical Specifications	1-3

Section 2 Preparing the GLS

2.1 Inspecting the Pump Tube	2-1
2.2 Discharge Tube	2-3
2.3 Installing a Bottle	2-3
2.4 Sample Cooling	2-4
2.5 Installing a Power Source	2-4
2.6 The Suction Line and Strainer	2-6
2.6.1 Cutting the Suction Line	2-6
2.6.2 Attaching the Strainer	2-6
2.6.3 Connecting the Vinyl Suction Line	2-7
2.6.4 Connecting the PTFE Suction Line	2-7
2.7 Connecting External Devices	2-8
2.8 Positioning the GLS	2-8
2.9 Locking the GLS	2-10

Section 3 Programming

3.1 Introduction to GLS Programming	3-1
3.2 GLS Interface	3-1
3.2.1. The GLS Display	3-2
3.2.2. The GLS Keypad	3-2
3.3 GLS Operating States	3-2
3.4 Programming	3-3
3.4.1. One-button Programming	3-3
3.4.2. Stored Programs	3-3
3.4.3. Standard Programming	3-3
3.5 Setting the Time and Date	3-8
3.6 Calibrating Sample Volumes	3-9
3.6.1. Calibration Step 1	3-10
3.6.2. Calibration Step 2	3-10
3.6.3. Calibration Step 3	3-11
3.6.4. Calibration Step 4	3-11
3.6.5. Calibration Step 5	3-11
3.6.6. Calibration Step 6	3-11
3.7 Manual Pump Operation	3-12
3.7.1. Run Pump in Reverse	3-12
3.7.2. Run Pump Forward	3-12

Section 4 Running a Program

4.1 Starting a Program	4-1
4.2 Program Start Times	4-1
4.3 Sampler Inhibit	4-1
4.4 Run State Displays	4-2
4.5 Sample Collection Cycle	4-3
4.6 Pausing or Stopping a Program	4-4
4.7 Program Completion	4-4
4.8 Post-sampling Activities	4-4
4.8.1 Recovering the Sampler	4-5
4.8.2 Preparing the Full Sample Bottle	4-5
4.8.3 Log	4-5
4.8.4 Errors	4-6
4.9 Grab Samples	4-7

Section 5 Servicing the Sampler

5.1 Servicing the Sampler	5-1
5.2 Routine maintenance	5-1
5.2.1. Cleaning	5-1
5.2.2. Replacing the Pump Tube	5-3
5.2.3. Replacing the Discharge Tube	5-5
5.2.4. Servicing Batteries and Power Packs	5-6
5.3 Preventive maintenance	5-6
5.3.1. Replacing the Internal Desiccant	5-6
5.3.2. Renewing the Desiccant	5-8
5.4 Diagnostics and Repair	5-9
5.4.1. GLS Self-diagnostics	5-9
5.4.2. Contacting Teledyne Isco for Assistance	5-11
5.4.3. Return Instructions	5-11

Section 6 GLS Options

6.1 Program Lock	6-1
6.2 Storing a Program	6-2
6.3 Disable Bottle Full Detection	6-3
6.4 Liquid Detector Disable	6-3
6.5 Pressurized lines	6-3
6.6 Foreign Language Displays	6-4
6.7 Software Updates	6-4
6.8 Accessories	6-4

Appendix A Replacement Parts

Appendix B Material Safety Data Sheets

Index

List of Figures

1-1 Major GLS Components	1-2
2-1 Pump housing cover and thumbscrews	2-2
2-2 Discharge tube and tube guide	2-3
2-3 Bottles for the GLS Sampler	2-4
2-4 Nickel-Cadmium Battery and Power Pack Position	2-5
2-5 946 lead-acid battery position	2-5
2-6 Attaching the suction line to the pump tubing	2-7
2-7 Sampler Locking	2-10
3-1 The GLS Keypad and Display	3-1
5-1 Liquid detector and pump housing covers removed	5-4
5-1 Discharge tube and tube guide	5-6
5-1 Internal Desiccant	5-7

List of Tables

1-1 GLS Technical Specifications	1-3
2-1 Strainers	2-10

GLS Compact Sampler

Section 1 Introduction

The GLS is a compact portable sampler that is ideal in applications where full-sized automated sampling is not practical. The small size and weight make the sampler easy to handle and transport from site to site. The GLS was designed for easy insertion and removal from manholes as small as 18 inches (457 mm) in diameter.

The GLS collects liquid samples and places them in a composite sample container. The largest sample containers will hold 2.5 gallons (10 liters). A dependable peristaltic pump delivers the liquid to the bottle. Its pump, coupled with the non-contacting liquid detector, gives you accurate, repeatable sample volumes time after time. The liquid detector is also used to halt the sampling routine when a full bottle is detected.

At the heart of the sampler is the GLS controller. It is environmentally sealed to provide protection from accidental submersion and long term exposure to high humidity and corrosive gases. Its tactile keypad and 2 line, 20 character display simplify operation. In just seconds, the one-button programming procedure will load the stored program settings and run the sampling routine.

1.1 About this Manual

This manual contains the information you will need to install, program, operate, and maintain a GLS sampler. There are six sections and three appendices:

- Section 1 *Introduction* lists the features and specifications of the GLS sampler, as well as compatible equipment, some typical applications, and a radio interference statement.
- Section 2 *Introduction* steps through installing the sampler and preparing it for use.
- Section 3 *Programming* shows how to enter programs.
- Section 4 *Running a Program* shows how to start a program and what to do upon program completion. This section also explains displayed errors, and how to take grab samples.
- Section 5 *Servicing the Sampler* covers basic maintenance required to keep your sampler in top operating condition.
- Section 6 *GLS Options* explains specialized software features that can be enabled for use. This section also lists order numbers for sampler accessories and cables.

- Appendix A *Replacement Parts*
- Appendix B *Material Safety Data Sheets*

1.1.1 Identifying GLS Components



Figure 1-1 Major GLS Components

1.1.2 Compatible Equipment

Compatible Teledyne Isco devices include:

- Teledyne Isco flow measuring instruments:
 - 4100 Series Flow Loggers
 - 4200 Series Flow Meters
 - 2100 Series Flow Modules
- Non-Teledyne Isco device interfaces:
 - 4-20 mA Input Interface
 - Pulse Duration Input Interface (contact Teledyne Isco's Special Products Department)
- Teledyne Isco parameter measuring instruments:
 - Liquid Level Actuator

1.1.3 Typical Applications

The GLS is designed to meet the needs of general purpose or priority pollutant sampling in municipal and industrial applications.

The GLS is part of Teledyne Isco's many automated sampling solutions which include the 3700 and 6700 Series samplers. This versatile product line meets the demands of:

- NPDES permit compliance
- Pre-treatment compliance

- Stormwater run-off
- Combined sewer overflow
- Sanitary sewer evaluations
- Non-point source sampling
- Biomonitoring

1.2 Radio Interference Statement

FCC Warning

Changes or modifications to this unit not expressly approved by the party responsible for compliance could void the user's authority to operate the equipment.

Note

This equipment has been tested and found to comply with the limits for a Class A digital device, pursuant to Part 15 of the FCC's rules. These limits are designed to provide reasonable protection against harmful interference when the equipment is operated in a commercial environment. This equipment generates, uses, and can radiate radio frequency energy and, if not installed and used in accordance with the instructions, may cause harmful, interference to radio communications. Operation of this equipment in a residential area is likely to cause harmful interference in which case the user will be required to correct the interference at his own expense.

Canada

This ISM apparatus meets all requirements of the Canadian Interference-Causing Equipment Regulations.

Ce générateur de fréquence radio ISM respecte toutes les exigences du Règlement sur le matériel brouilleur du Canada.

1.3 Technical Specifications

Table 1-1 contains technical specifications for the GLS Compact Sampler.

Table 1-1 GLS Technical Specifications	
Sampler	
Height	26.5 in (67.3 cm)
Diameter	16.5 in (41.9 cm)
Dry Weight	24.5 lbs (11.1 kg)
Sampler base Capacity	1.0 or 2.5 gallon polyethylene or glass container.
Power Requirements	12 volts DC. (Supplied by battery or AC power converter.)
Controller	
Weight	8.0 lbs (3.6 kg)
Dimensions	10 × 12.5 × 10 in (26 × 32 × 25 cm)
Operational Temperature	32° to 120° F (0° to 49° C)
Enclosure Rating	NEMA 4X, 6 and IP67

Table 1-1 GLS Technical Specifications (Continued)

Program Memory	Non-volatile ROM
Flow Meter Signal Requirements	5 to 15 volt DC pulse or 25 millisecond isolated contact closure.
Number of Composite Samples to Shutoff	Up to 500 (maximum)
Real Time Clock Accuracy	1 minute per month, typical
Pump	
Intake Purge	Purges before and after each sample.
Tubing Life Indicator	Provides a message to change pump tubing.
Intake Suction Tubing Length Material Inside Dimension	3 to 99 ft (1 to 30 m) Vinyl or PTFE lined. 0.375 in or 0.250 in (0.952 cm or 0.635 cm)
Pump Tubing Life	2,000 samples
Maximum Suction Lift	26 ft (7.9 m)
Typical Repeatability	± 10 ml
Typical Line Transport Velocity (with 3/8" line) at head heights of: 3 ft (0.9 m) 10 ft (3.1 m) 15 ft (4.6 m)	2.9 ft/s (0.88 m/s) 2.5 ft/s (0.76 m/s) 1.9 ft/s (0.58 m/s)
Liquid Presence Detector	Non-wetted, non-conductive sensor detects when liquid sample reaches the pump to automatically compensate for changes in head heights.
Software	
Sample Frequency Selection	1 minute to 9,999 minutes, in 1 minute increments 1 to 9,999 flow pulses
Sampling Modes	Uniform time flow. (Flow mode is controlled by external flow meter pulses.)
Programmable Sample Volumes	10 to 9,990 ml in 1 ml increments
Program Storage	1 sampling program
Controller Diagnostics	Tests for RAM, ROM, pump, and display.

GLS Compact Sampler

Section 2 Preparing the GLS

The following checklist can be used as a guide to prepare the GLS for each use.

1. Inspect the pump tube, section 2.1
2. Check the discharge tube, section 2.2
3. Install the bottle, section 2.3
4. Icing the bottle (optional), section 2.4
5. Connect a power source, section 2.5
6. Connect a suction line and strainer, section 2.6
7. External connections (essential for flow-paced sampling or sampler inhibiting), section 2.7
8. Place the GLS in position, section 2.8
9. Calibrate sample volumes (optional), section 3.6
10. Lock the GLS (optional), section 2.9

2.1 Inspecting the Pump Tube

Inspect the pump tube before running a program. If the pump tube fails, the GLS will not be able to collect samples.

Note

The importance of regular tubing replacement cannot be overstated. The key is to replace the tube before failure, not after. When a pump tube ruptures, grit and other abrasive debris can be driven into the pump shaft seal. Over time, this abrasive material will degrade the pump seal, jeopardizing the NEMA 4x 6 rating of the controller.

Failure to maintain the pump tube may result in permanent damage to the sampler. Check the condition of the pump tube regularly and if the tube shows signs of fatigue or wear, replace it immediately. A properly maintained sampler will provide the years of reliable service that is expected of a Teledyne Isco Sampler.

WARNING

Pump may actuate without warning. To avoid injury, sampler must be off when pump housing cover is removed for inspection or tubing replacement.

To inspect the pump tube:

1. Disconnect the power from the 12V Input Power connector.
2. Remove the pump housing cover by loosening the four thumbscrews.
3. Visually inspect the pump tube for cracks where it is compressed by the rollers. If the tube is cracked, it must be replaced. Refer to section 5.2.2..
4. Visually inspect the inside of the pump housing. The housing and rollers should be free from debris.
5. Replace the pump housing cover and tighten the thumbscrews.

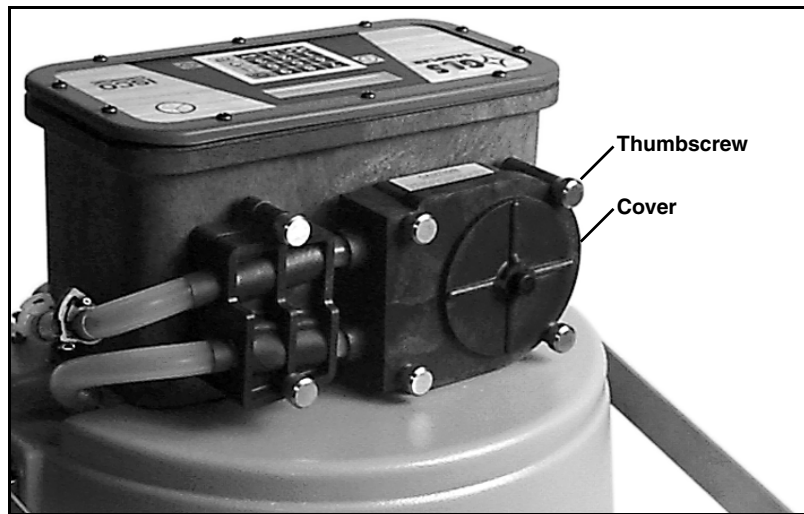

Figure 2-1 Pump housing cover and thumbscrews

Note

The GLS will display a pump tube warning as part of the View Log screens when it exceeds 500,000 pump counts. This is the recommended pump tube replacement interval. The pump tube warning is based on a number of pump revolutions. The GLS cannot “detect” a weak or worn pump tube. The pump tube replacement interval should be sufficient for most applications. If you are sampling abrasive liquids or liquids with a high content of suspended solids, you may find that the pump tube requires replacement more frequently.

Note

The GLS will give you an option to reset the pump tube count to 500,000 after it displays the warning message.

Note

Teledyne Isco pump tubes are made from medical-grade Silastic™ tubing. This tubing will not contribute any organic material to the samples.

2.2 Discharge Tube

The discharge tube is located inside the center section. It is a $\frac{3}{8}$ inch (9 mm) I.D., $8\frac{1}{4}$ inch (210 mm) long piece of medical-grade Silastic™ tubing.

The discharge tube should be well fitted over the bulkhead fitting and routed through the tube guide. The tube must be free of twists or kinks. The tube should extend about $1\frac{1}{2}$ inches (38 mm) past the end of the tube guide (even with the bottom of the center section). This length of tubing is necessary for the GLS to detect an overfilled bottle.

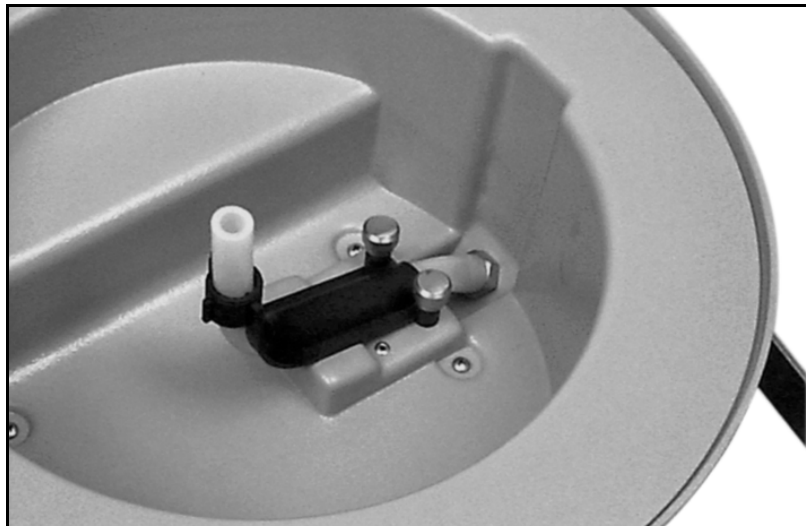

Figure 2-2 Discharge tube and tube guide

2.3 Installing a Bottle

The base section of the GLS is designed to hold five different types of bottles (see Figure 2-4):

- 2.5 gallon (10 liter) low density polyethylene
- 2.5 gallon (10 liter) glass
- 1 gallon (3.8 liter) polypropylene. Requires the use of the bottle deck.
- 1 gallon (3.8 liter) glass. Requires the use of the bottle deck.
- 2 gallon (7.6 liter) ProPak

To install the bottle:

- **2.5 and 2 gallon (10 and 7.6 liter)** – place the bottle in the GLS base section.
- **1 gallon (3.8 liter)** – place the bottle deck into the GLS base section. Set the bottle on top of the bottle deck.

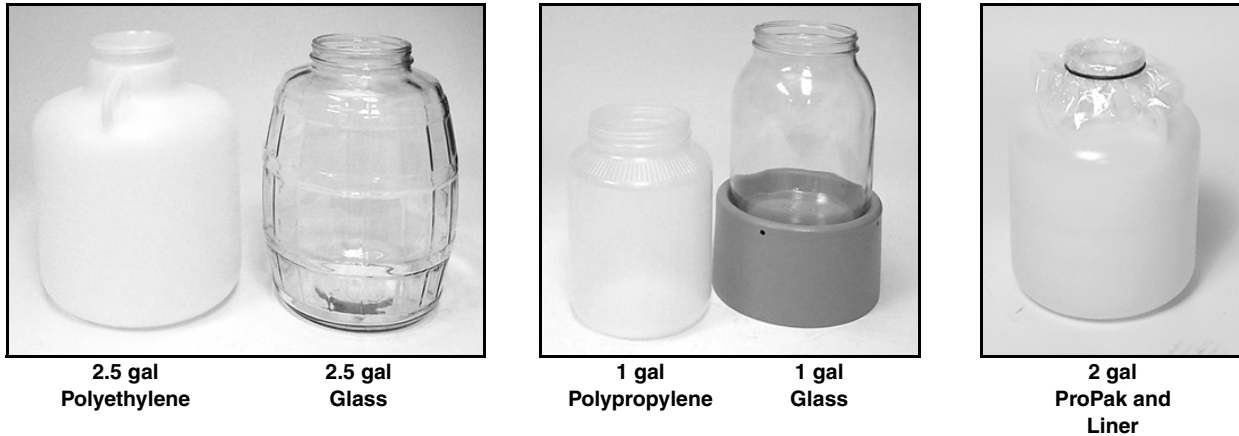

Figure 2-3 Bottles for the GLS Sampler

2.4 Sample Cooling

You can cool the samples by placing crushed ice around the outside of the bottle. When using a 2 or 2.5 gallon (7.6 or 10 liter) bottle, the base section can hold 10 pounds (4.5 kg) of ice. When a bottle deck and 1 gallon (3.8 liter) bottle is installed, the base section can hold 14 pounds (6.3 kg) of ice. Frozen gel packs are sometimes a convenient alternative to ice.

The center section and base of the GLS are insulated.

For maximum cooling, fill the base (with the bottle and deck in place) with water and freeze the base section and its contents.

2.5 Installing a Power Source

The GLS must be powered by a 12-Volt DC power source. Teledyne Isco recommends using one of the following 900 series power sources:

Batteries –

- 934 Nickel Cadmium Battery, 4.0Ah
- 946 Lead-Acid Battery, 6.5Ah

Power Packs –

- 913 High Capacity Power Pack, 120 Volts AC
- 923 High Capacity Power Pack, 240 Volts AC
- 914 Battery Backed Power Pack, 120 Volts AC
- 924 Battery Backed Power Pack, 240 Volts AC

To install a Teledyne Isco 900 power source:

1. Place the power source into the center section recess. Refer to the following photos for correct positions:

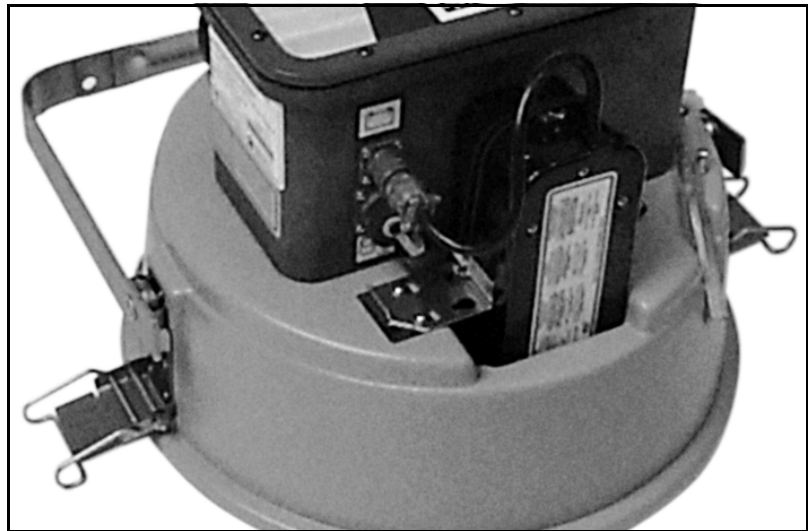

Figure 2-4 Nickel-Cadmium Battery and Power Pack Position

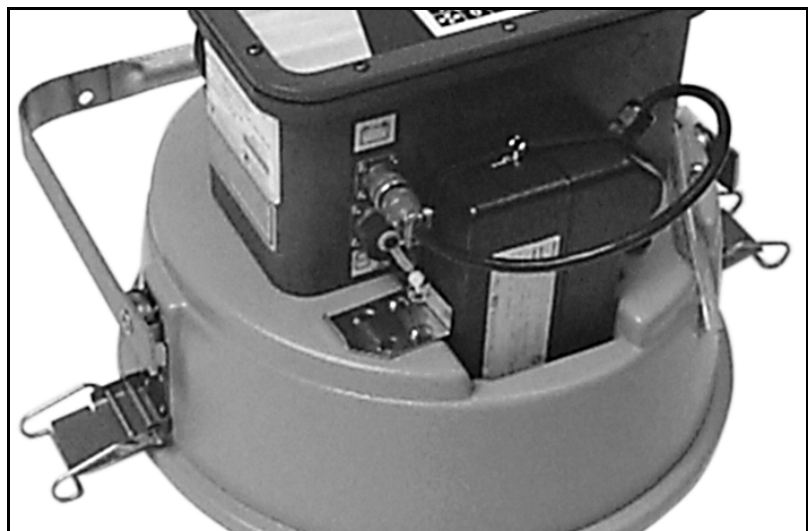

Figure 2-5 946 lead-acid battery position

2. Secure the power source by pulling the elastic bands over it and attach the clip to the two posts. Note that there are two sets of holes – use the set that places the clip against the power source.
3. Attach the two-pin connector to the Input Power connector on the back of the controller.
4. Power Packs Only – Route the AC line cord through the center section's Tubing/Cable port.

Note

If you use a battery to power the GLS, always install a fully charged one before running a program.

 **Note**

Refer to Teledyne Isco's *Power Products Guide*, P/N 60-9003-092 for a complete description of each power source.

2.6 The Suction Line and Strainer

The suction line carries the liquid from the sampling point to the GLS pump tubing. The GLS is designed to use:

- 1/4-inch (6 mm) I.D. Vinyl tubing
- 3/8 -inch (9 mm) I.D. Vinyl tubing
- 3/8 -inch (9 mm) I.D. PTFE tubing with a protective polyethylene jacket

The strainer reduces the possibility of debris plugging the suction line. Several types are available:

- Standard Weighted Polypropylene (3/8 -inch I.D. only)
- CPVC body (3/8 -inch I.D. only)
- Stainless Steel 1/4 and 3/8 -inch

Your application will dictate the best combination of suction line and strainer.

To prepare the suction line and strainer:

1. Cut the suction line to the shortest feasible length.
2. Attach a strainer to the suction line.
3. Connect the suction line to the pump tube.

 **Note**

The vinyl suction line does contain a very low ppm (parts per million) level of phenols. If this affects your samples, use the PTFE suction line.

2.6.1 Cutting the Suction Line

The suction line should be cut to the shortest feasible length. This reduces the possibility of cross-contamination between sample volumes and extends the battery life. The suction line can be easily cut with a knife.

When cutting the suction line, keep in mind that the length must be cut to the nearest whole foot or decimeter. The length is measured from end to end, without the strainer or tubing coupler.

If you have altered the length, press the Calibrate button , and enter the new suction line dimensions.

2.6.2 Attaching the Strainer

Items required:

Strainer

Suction line

To attach the strainer to the suction line:

1. Heat the end of the suction line to make it more pliable.
2. Screw the threaded end of the strainer into the suction line.

2.6.3 Connecting the Vinyl Suction Line

Attach vinyl suction line to the pump tubing with the tube coupler. Two couplings are available, one for each size of vinyl line. Attach the vinyl suction line to the pump tube with the tubing coupler. First, screw the threaded end into the suction line until the flat surface is flush against the suction line (Figure 2-6). Then, push the other end of the coupler into the end of the pump tube until the other flat surface is flush against the tubing.

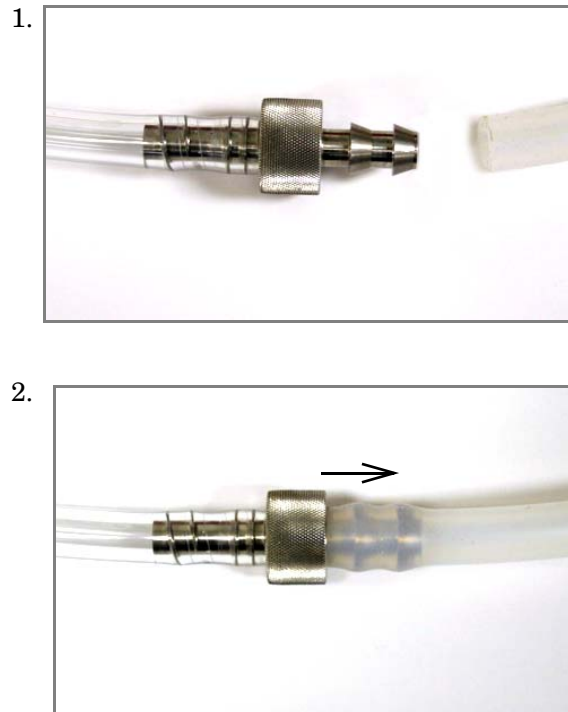

Figure 2-6 Attaching the suction line to the pump tubing

Once the coupler is attached to the pump tube, removal is difficult, and may require cutting the tube.

2.6.4 Connecting the PTFE Suction Line

To connect the $\frac{3}{8}$ -inch (9 mm) PTFE suction line to the pump tube:

Items required:

- Suction line with strainer attached
- $\frac{3}{4}$ -inch (19 mm) diameter hose clamp
(plastic or stainless steel recommended)

To attach the suction line:

1. Place a hose clamp on the upper pump tube.
2. Insert about 1 inch (25 mm) of the PTFE suction line into the upper pump tube.
3. Position the clamp over the joined area and tighten it.

2.7 Connecting External Devices

The GLS can be used with external devices that control the sampler pacing, sampler inhibiting, or both. The sampler pacing input can control the rate of sample collection so that it is proportional to the flow rate of a channel. This input must be used when the Flow Paced program option is selected. The sampler inhibit input can delay the GLS operation until a monitored parameter meets user-defined conditions.

These devices connect to the 6-pin Flow Meter Connector located on the back of the GLS controller. Compatible Teledyne Isco devices include:

- Pacing and Inhibiting devices:
 - 4100 Series Flow Loggers
 - 4200 Series Flow Meters
 - 2100 Series Flow Meters
- Pacing devices (non-Teledyne Isco device interfaces):
 - 4-20 mA Input Interface
 - Pulse Duration Input Interface (contact Teledyne Isco's Special Products department)
- Inhibiting devices:
 - Liquid Level Actuator

Note

Flow pacing input signal (pin C) requirements – a 5 to 15 volt DC pulse or isolated contact closure of at least 25 milliseconds in duration.

Note

Sampler inhibit signal (pin F) requirements – a low (grounded) level of at least 5 seconds inhibits the operation. A high (or open) level of at least 5 seconds in duration restores the operation.

2.8 Positioning the GLS

There are a few considerations when selecting a site for the GLS. The foremost concern should be personal safety.

WARNING

The installation and use of this product may subject you to hazardous working conditions that can cause you serious or fatal injuries. Take any necessary precautions before entering the worksite. Install and operate this product in accordance with all applicable safety and health regulations and local ordinances.

The following points should also be considered:

- Level surface – The GLS should be placed on a level surface to prevent tipping or spills.

- **Support** – The surface or mounting method must be able to support the GLS at full capacity. A GLS with battery, full sample bottle, and ice may weigh as much as 63 pounds (28.6 kg).
- **Environmental** – The GLS is designed for use in harsh environments. However, you should avoid installing the GLS in locations where its components are subject to chemical attack. Also, prolonged exposure to direct sunlight will eventually damage the ABS exterior.
- **Avoid submersion** – Although its controller will resist damage (rated NEMA 4x, 6), the GLS cannot prevent the liquid from entering the base and center sections. Liquid entering the base section while the GLS is submerged will most likely invalidate the collected samples.
- **Accessibility** – The GLS must be installed in a location where it can be recovered easily without tipping or difficult maneuvering.
- **Security** – The location may need to provide some degree of security to prevent tampering or vandalism. See also the sampler locking (Section 2.9) and the program lock options (Section 6.1).

The GLS can be installed in a manhole using the optional suspension harness (P/N 60-2954-033). Contact your sales representative or Teledyne Isco for more information.

After the GLS is in place, the strainer and suction line should be properly positioned.

The strainer should be placed in the stream so that representative samples are collected. The intake should be in the main flow, not in an eddy or at the edge of flow. Its depth in the stream can also be important. An intake placed at the bottom of the stream may result in excess heavy solids, while placement at the top may result in the opposite.

The suction line should always be cut to the shortest possible length. Route the suction line so that it runs continuously downhill. Loops of coiled suction line or low areas where the liquid can pool will hold residual amounts of liquid that will cross-contaminate sample volumes. A consistent downhill slope will help eliminate air slugs in the line, increasing the sample-to-sample repeatability and accuracy.

The suction line will tend to float when sampling from deep flow streams. Refer to Table 2-1. If the depths listed in the chart are exceeded, anchor the line securely so that the suction line and strainer do not become dislodged.

When the sampler is used in below freezing temperatures, there is a risk of the suction line being frozen. A suitably warm sampling source can usually prevent this, provided there are no loops in the suction line. Some situations may require more protective measures, such as insulation of the suction line, or heat tape. Thoroughly draining the suction line minimizes the possibility of frozen liquid clogging the line.

Table 2-1 Strainers			
Strainer	Vinyl		PTFE
	1/4-inch (6 mm)	3/8-inch (9 mm)	3/8-inch (9 mm)
Standard Weighted Polypropylene	—	22 feet (6.7 m)	15 feet (4.5 m)
Stainless Steel Low Flow	14 feet (4.3 m)	22 feet (6.7 m)	15 feet (4.5 m)
CPVC	—	4 feet (1.2 m)	4 feet (1.2 m)

2.9 Locking the GLS

Access to the inside of the GLS can be easily secured by placing a padlock on the carrying handle. Because the carrying handle must be repositioned before gaining access, locking the handle in an upright position secures the top cover, center section and controller, and the base.



Figure 2-7 Sampler Locking

GLS Compact Sampler

Section 3 Programming

3.1 Introduction to GLS Programming

This section shows you how to program the GLS. In this section you will find:

- The GLS Interface – This explains how you operate the GLS using the keypad and display. Section 3.2.
- Operating States – This explains the many states of operation. Section 3.3.
- Programming Instructions – This section provides instructions on One-button Programming and Standard Programming. Section 3.4.
- Setting the time and date – This section explains how to set the internal clock. Section 3.5.
- Calibrating sample volumes – instructions for calibrating sample volumes. Section 3.6
- Manual pump operation– instructions for running the pump forward and reverse. Section 3.7

3.2 GLS Interface

The GLS is easily programmed and operated from the controller front panel. The front panel holds the liquid crystal display and the keypad. The front panel also includes an internal case humidity indicator.

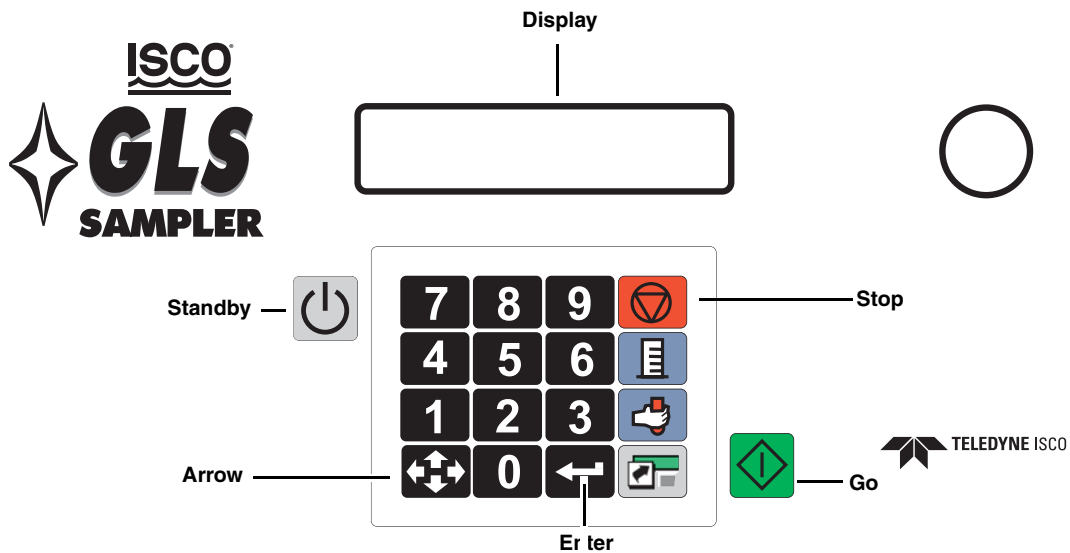

Figure 3-1 The GLS Keypad and Display

3.2.1. The GLS Display

The Control panel holds a 2-column, 20-character liquid crystal display. Through this display, the GLS reports all of the possible operating states.

The display will also show messages as needed. These messages alert you to unusual conditions or the need for servicing. Messages may alternate with the current display, such as “ERRORS HAVE OCCURRED,” or at the end of a sequence of screens, such as “WARNING: CHANGE PUMP TUBE.”



3.2.2. The GLS Keypad

The GLS accepts input from the 18-button keypad. The operating state will determine which buttons are active.

3.3 GLS Operating States

The GLS has many states of operation. States of operation can be classified as either “interactive” or “non-interactive.”

Interactive States - •

- **Standby** — The display shows “PROGRAM, VIEW LOG,” and the current time and date. This is an interactive state and the GLS is waiting for your input. You will see that one of the items is blinking; this is the current selection and will be accepted if the Enter button  is pressed. You can change the selected item by pressing the Arrow button .
- **Program** — The display shows programming options or number-entry screens. Again, this is an interactive state through which you can modify the operation of the sampler controller.
- **Paused** — Pressing the Stop key while the sampler is running a program places the GLS in the Paused state. This is an interactive state where you can choose to view the event log, return to the Run state, or halt the sampling routine.
- **Time and Date** — the displays shows “ENTER TIME AND DATE:” This is an interactive state used to set the correct time and date.

Non-interactive States -

- **Off** — The display is blank. In this state, a few sampler functions continue to operate, even without its external 12-volt DC power source. An internal battery powers the real-time clock to maintain the correct date and time. When an external 12-volt DC power source is connected, the GLS will respond only to the On/Off button.
- **Run** — The display shows information about a running program. This is typically the current activity, such as “TAKING SAMPLE __ OF __,” or when the next event is to occur, such as “SAMPLE __ OF __ IN MM:SS.”
- **Done** — The display shows “PROGRAM DONE.” This state reports that the GLS has finished running the program. Pressing any key will place the sampler in the Standby state.
- **View Log** — The display “scrolls” through the event log.

3.4 Programming

There are two ways to program the GLS:

- One-button Programming
- Standard Programming

One-button Programming quickly loads program settings from a stored program and runs the sampling routine.

Standard Programming allows you to step through the current GLS program settings, making any necessary modifications.

3.4.1. One-button Programming

The One-button Programming feature of the GLS allows you to load the Stored program settings and run the program in one quick and simple step.

To use the One-button Programming, press:



This sequence of buttons must be pressed within 10 seconds.

3.4.2. Stored Programs

At all times the GLS holds two programs, the Stored program and the Current program. The Stored and Current program settings may or may not be the same. When you press the Go button, the GLS runs the Current program settings.

The One-button Programming restores the Current program settings to that of the Stored program.

The GLS is shipped from the factory with the following stored program settings:

- Time Paced
- 15 Minute Pacing Interval
- 9400 ml Bottle Volume – for 2.5 gallon (10 liter) bottles
- Take 96 Samples – covers a 24-hour time period
- 80 ml Sample Volume
- No Delay to First Sample
- $\frac{3}{8}$ -inch by 25-foot suction line

Note

Re-initializing the GLS or updating its software will restore the factory program settings.

3.4.3. Standard Programming

Standard Programming allows you to step through the current GLS program settings and make any necessary modifications.

To access the Standard Programming, select Program from the Standby screen and press Enter.

The seven-step Standard Programming goes through the following settings:

- Pacing – Choose from time or flow paced sampling. Flow paced sampling requires an external flow metering instrument.

- Interval – Set the pacing interval in minutes or flow pulses.
- Bottle Volume – Enter the capacity of the bottle installed in the GLS base section.
- Number of Samples – Set the number of samples to collect or place the GLS in the Continuous Sampling mode.
- Sample Volume – Enter the desired volume to collect at each sample event.
- Program Start Time– After pressing the Go button GLS can immediately take the first sample or wait for a programmed start time and date.
- Suction Line – Enter the type of suction line in use. This step also includes the Sample Volume Calibration procedure.



3.4.3.1 Sample Pacing

```
TIME PACED
FLOW PACED
```

Programming Step #1 – Pacing

The GLS displays two pacing options – Time Paced and Flow Paced. Select Time to collect samples at uniform time intervals. Select Flow to collect samples based on flow volumes. An input signal from an external instrument is required when you select Flow Paced.

The current selection will be blinking. To program the pacing method:

1. Press the Arrow button  to select an option.
2. Press the Enter button  to accept the blinking option. The GLS loads the option into the current program settings and advances to the next step.

3.4.3.2 Pacing Interval

```
15 MINUTES
BETWEEN SAMPLES
```

```
10 FLOW PULSES
BETWEEN SAMPLES
```

Programming Step #2 – Pacing Interval

After selecting the pacing method in Step #1, the program now needs a pacing interval. A pacing interval is a value that the sampler will “count down” from after each sample event. Time paced programs will count down an interval in minutes using its internal clock. Flow paced programs will count down the number of flow pulses it receives from an external device.

The Pacing Interval display will show “minutes” or “flow pulses” according to the previously selected pacing method.

You can accept the interval by pressing the Enter button , or change the setting. To change the setting:

1. Enter the new value using the number buttons. The GLS will accept intervals from 1 to 9,999.

Tip – If you enter an incorrect value, press the Stop button . The GLS will restore the original setting and wait for a new value.

2. Press the Enter button  to accept the new value. The GLS loads the value into the current program settings and advances to the next step.

3.4.3.3 Bottle Volume

```
BOTTLE VOLUME
9400ml (3500-20000)
```

Programming Step #3 – Bottle Volume



In this programming step, enter the capacity of the bottle installed in the base section of the sampler. As shown on the display, acceptable values range from 3500 to 20000 milliliters.

The GLS typically uses standard bottles provided by Teledyne Isco. When using Teledyne Isco's standard bottles refer to the chart below for recommended values. You will note that the value is less than the total capacity. This reduces the possibility of missed samples due to a Bottle Full error, or spills when recovering the sampler.

Bottle Description	Enter this value (in milliliters)...
2.5 gallon (10 liter) glass	9400
2.5 gallon (10 liter) polyethylene	9400
1 gallon (3.8 liter) glass	3500
1 gallon (3.8 liter) polyethylene	3500
2 gallon (7.6 liter) ProPak liner	7000

You may use a non-standard bottle in the GLS. When entering the non-standard bottle volume, it is advisable to enter a value less than the total volume. Again, this will reduce the possibility of missed samples and spills.

To enter the Bottle Volume:

1. Press the appropriate number buttons on the keypad. The GLS requires all four numbers.
Tip – If you enter an incorrect value, press the Stop button . The GLS will restore the original setting and wait for a new value.
2. Press the Enter button  to accept the new value. The GLS loads the value into the current program settings and advances to the next step.

Note

The actual total volume deposited in the bottle is subject to a cumulative error.

Note

The true bottle size can be entered. However, this increases the likelihood that the cumulative error may cause samples to be missed or spilled.

Note



Overfilling the bottle or missing samples can affect your sampling results. In some applications, missed or spilled samples may render the bottle contents to be less than a representative composite sample.

3.4.3.4 Number of Samples

```
TAKE 10 SAMPLES  
(1-999)
```

Programming Step #4 – Number of Samples

Enter the number of samples to collect. To enter the number of samples:

1. Press the appropriate number buttons on the keypad.
Tip – If you enter an incorrect value, press the Stop button . The GLS will restore the original setting and wait for a new value.
2. Press the Enter button  to accept the new value. The GLS loads the value into the current program settings and advances to the next step.

Continuous Sampling Mode

The GLS can be placed in a Continuous Sampling mode. In this mode, the GLS collects samples without regard for the total number of samples. Samples are collected until the Liquid Detector senses a full bottle condition. (Sample volumes should be greater than 60 ml for the liquid detector to reliably sense this condition.) The GLS then halts the sampling routine. To enable the Continuous Sampling mode:



1. At the “TAKE XX SAMPLES” display, press the Zero button **0**.
2. Press the Enter button . The GLS is placed in the Continuous Sampling mode and advances to the next programming step.

3.4.3.5 Sample Volume

```
SAMPLE VOLUME  
80 ml (10-930)
```

Programming Step #5 – Sample Volume

Enter the volume to collect at each sampling event. This value must be within the range shown on the GLS display. To enter the sample volume:

1. Press the appropriate number buttons on the keypad.
Tip – If you enter an incorrect value, press the Stop button . The GLS will restore the original setting and wait for a new value.
2. Press the Enter button  to accept the new value. The GLS loads the value into the current program settings and advances to the next step.

Note



Sample volumes greater than 50 ml are recommended. This volume is necessary for the bottle full detection to work properly.

3.4.3.6 Program Start Time

```
NO DELAY TO START  
SET START TIME
```

Programming Step #6 – Program Start Time

The sampling program can be delayed to start at a user-specified time and day. To define the start time:

1. Use the Arrow button  to select “NO DELAY TO START” or “SET START TIME,” then press the Enter button .
Select “NO DELAY TO START” to take the first sample immediately after the Go button is pressed. If you select

this option, programming advances to step #7, *Suction Line* (section 3.4.3.7).

Select the “SET START TIME” to delay the first sample until a programmed time and date. If you select this option the GLS advances to the “FIRST SAMPLE AT” display.

FIRST SAMPLE AT:
08:00 21-APR-11

2. Enter the start hour with the number entry buttons. The hours must be entered in a 24-hour (military time) format. For example, 5:00 p.m. is 17:00 on a 24-hour clock. Press the Enter button to accept the hour setting and advance the cursor to the minutes.
- Tip** – If you enter an incorrect value, press the Stop button . The GLS will restore the original setting and wait for a new value.
3. Enter the minutes with the number entry buttons. Press the Enter button to accept the minutes setting and advance the cursor to the day setting.
 4. Enter the start date with the number entry buttons. Press the Enter button to accept the date and advance the cursor to the month setting.
 5. Enter the number of the month (for example, August = 08) with the number entry buttons. Press the Enter button and the GLS abbreviates the name of the month and advances the cursor to the year setting.
 6. Enter the last two digits of the year (for example, 2003 = 03). Press the Enter button to accept the year.

 **Note**

If the programmed start time elapses before running the program, the GLS will take the first sample immediately after the Go button is pressed.

If you selected “TIME PACED” in step #1, (section 3.4.3.1), the GLS advances to step #7, *Suction Line*. If you selected “FLOW PACED,” the GLS advances to the “MAXIMUM RUN TIME” display.

MAXIMUM RUN TIME:
168 HOURS

Some sampling protocols require a known composite sampling interval, that is, the run time of a sampling program. For time-paced sampling programs, the run time is the number of samples multiplied by the pacing interval. But for flow-paced sampling, the run time may vary widely because of the dependency on flow rates.

- If your sampling protocol requires a known run time, enter the number of hours for the MAXIMUM RUN TIME. If the GLS has not yet completed the sampling program, it will end the sampling program when it reaches the MAXIMUM RUN TIME.
- If your sampling protocol does not have this requirement, enter “0” (zero). The GLS will run until it completes the total number of samples.

3.4.3.7 Suction Line

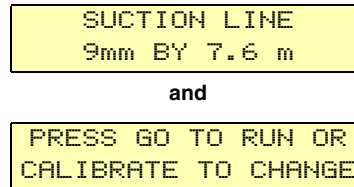

Programming Step #7 – Calibrate Sample Volumes

The display alternates between:



This Suction Line display reports the suction line diameter and length. This information must be correct so that the GLS can deliver sample volumes as programmed. Verify that the diameter and length match the suction line in use.

If the suction line settings are correct, calibration is not necessary. To skip the calibration, press:

- The Go button  to run the program, or,
- The Enter button  to accept the values and return to the Standby state.

If the settings do not match the suction line in use, you must enter new values. Press the Calibrate button  and proceed with the Calibration steps.

Note



While the two displays alternate, the GLS is counting down a five-minute time interval. If you do not press a button during this count down, the GLS times out and automatically runs the current program.

Note

If your sampling protocol requires the utmost volume accuracy, step through the calibration procedure and check the delivered sample volume. Calibration may improve the GLS's volume accuracy.

3.5 Setting the Time and Date

Should it become necessary to set the time or date, do the following:

1. From the standby state, press the Arrow button  until the time and date is blinking.
2. Press the Enter button  to access time and date entry display. The cursor is waiting for you to enter the current time.
3. Enter the hours with the number entry buttons. The hours must be entered in a 24-hour (military time) format. For example, 5:00 p.m. is 17:00 on a 24-hour clock. Press the Enter button to accept the hour setting and advance the cursor to the minutes.

Tip – If you enter an incorrect value, press the Stop button . The GLS will restore the original setting and wait for a new value.

4. Enter the minutes with the number entry buttons. Press the Enter button to accept the minutes setting and advance the cursor to the day setting.
5. Enter today's date with the number entry buttons. Press the Enter button to accept the date and advance the cursor to the month setting.
6. Enter the number of the month (for example, August = 08) with the number entry buttons. Press the Enter button and the GLS abbreviates the month and advances the cursor to the year setting.
7. Enter the last two digits of the year (for example, 1999 = 99). Press the Enter button to accept the year and return to standby.

3.6 Calibrating Sample Volumes

Overview:

The GLS can deliver sample volumes repeatable to ± 10 ml. The GLS relies on you to enter correct suction line diameter and length values. The GLS uses these values to:

- Generate internal pump tables to “measure” the liquid volume
- Calculate the suction head.

By calculating the suction head, the delivered volumes are not affected by varying liquid levels. The GLS automatically calculates the suction head using input from the Liquid Detector.

Incorrect suction line values or disabling the liquid detector may adversely affect the volume accuracy.

Calibrating the sampler can enhance sample volume accuracy.

To calibrate sample volumes, press the Calibrate button  and follow the abbreviated steps below, or the steps in Sections 3.6.1. through 3.6.6.

1. Enter the suction line size.
2. Enter the suction line length.
3. If the liquid detector is disabled, the GLS will ask for a manual or “fixed” suction head since it will not be able to calculate the head.
4. Check the sample volume. This process deposits the programmed sample volume into a container so you can measure the delivered volume. You can then enter the actual volume delivered to refine the GLS pump tables. Be sure to disconnect the pump tube at the bulkhead fitting when calibrating samples.

Repeat these steps to check volume accuracy.

 **Note**

Selecting 1/4 inch (6 mm) suction line disables the Bottle Full detection.

 **Note**

The suction line should maintain a consistent downhill slope to achieve the best sample-to-sample repeatability and accuracy.

3.6.1. Calibration Step 1



```
SUCTION LINE SIZE:
  6 mm   9 mm
```

Press the Calibrate button . The GLS advances to the Suction Line Size display.

The Suction Line Size is the inside diameter (I.D.) of the suction line tubing. Two sizes of suction line may be used with the GLS:

- 1/4-inch (6 mm) I.D.
- 3/8-inch (9 mm) I.D.

To set the suction line size:

1. Determine the size of suction line in use. Compare this to the blinking selection.
2. If the selection is incorrect, press the Arrow button . This will change the blinking selection.
3. Press the Enter button  to accept the selection. The GLS loads the size into the current program settings and advances to the next step.

 **Note**

Selecting 1/4 inch (6 mm) suction line disables the Bottle Full detection.

3.6.2. Calibration Step 2

```
SUCTION LINE LENGTH:
  7.6 m (0.9-30.2)
```

The Suction Line Length is the measured length of tubing in use. The length is measured from end-to-end, without the strainer or tube coupling. When using English units of measure, the suction line tubing must be cut in whole foot lengths. When using metric units of measure, the tubing must be cut in decimeter lengths.

To enter the Suction Line Length:

1. Measure the length of tubing. Cut the tubing if necessary, to the nearest whole foot or decimeter.
2. Enter the tubing length. Press the appropriate number buttons on the keypad.

Tip – If you enter an incorrect value, press the Stop button . The GLS will restore the original setting and wait for a new value.

3. Press the Enter button  to accept the value. The GLS loads the length into the current program settings and advances to the next step.

3.6.3. Calibration Step 3

```
SUCTION HEAD
3.1 m (0-7.6 m)
```

This step only appears when the liquid detector is disabled. Since the GLS will be unable to calculate the suction head as it collects each sample, the GLS will ask for a manual or “fixed” suction head. The GLS skips this step when the Liquid Detector is enabled.

To enter the Suction Head:

1. Measure the Suction Head height.
2. Enter the height. Press the appropriate number buttons on the keypad.

Tip – If you enter an incorrect value, press the Stop button . The GLS will restore the original setting and wait for a new value.

3. Press the Enter button  to accept the value. The GLS loads the fixed Suction Head into the current program settings and advances to the next step.

3.6.4. Calibration Step 4

```
CHECK SAMPLE VOLUME?
YES NO
```

Checking the sample volume is recommended if ultimate accuracy is required by your sampling protocol.

The default selection is NO. To accept this, press the Enter button. The GLS will return to the Standby state.

To check sample volumes, select YES by pressing the Arrow button , and then press the Enter button. The GLS will continue with the calibration steps.

3.6.5. Calibration Step 5

```
CALIBRATE VOLUME
PRESS ← WHEN READY!
```

The GLS will wait while you prepare to collect a sample.

To prepare:

1. Pull the lower pump tube end from the bulkhead fitting.
2. Hold the pump tube outlet over a graduated cylinder, such as Teledyne Isco’s 1000 ml plastic graduated cylinder, P/N 299-0020-00.
3. Press the Enter button  and the GLS will start to collect the sample.

```
TAKING 200 ml
CALIBRATE SAMPLE
```

The GLS displays the screen above and goes through a complete sample collection cycle. The GLS deposits the sample in the graduated cylinder.

 **Note**

The volume delivered during calibration is the programmed Sample Volume.

3.6.6. Calibration Step 6

```
VOLUME DELIVERED
200 ml
```

The GLS displays the amount of liquid it has deposited into the graduated cylinder.

Measure the volume and compare the numbers. If they match, press Enter and the GLS will return to the Standby state.

```
___m! ARE YOU  
SURE? YES NO
```

If the amounts differ, enter the actual volume delivered. To enter the actual volume:

1. Enter the measured volume. Press the appropriate number buttons on the keypad.

Tip – If you enter an incorrect value, press the Stop button . The GLS will restore the original setting and wait for a new value.

2. Press the Enter button  to accept the value. The GLS updates its internal pump tables. If there is a significant difference between the old and new values, the GLS displays the screen at left.

3. Compare this value with the measured volume.

If they match, select YES using the Arrow button and then press Enter.

If they do not match, select NO using the Arrow button and then press Enter. The GLS returns to the Volume Delivered screen (step 1, above).

When through with Calibration Step 6, the GLS logs the calibration time in the event log and returns to the Standby state. Be sure to reconnect the pump tube end to the bulkhead fitting.

3.7 Manual Pump Operation

If necessary, you can manually run the pump forward or in reverse from the standby screen. The standby screen displays “PROGRAM, VIEW LOG,” and the current time and date.

3.7.1. Run Pump in Reverse

From the standby screen, press “1.” You will see the following display:

```
PRESS ↵ TO  
PUMP REVERSE
```

The display will be shown for four seconds, but the Press Enter command is active for five minutes, unless another key is pressed to cancel.

Press the Enter button  to run the pump in reverse. When the process is complete, you will be returned to the standby screen.

3.7.2. Run Pump Forward

From the standby screen, press “3.” You will see the following display:

```
PRESS ↵ TO  
PUMP FORWARD
```

The display will be shown for four seconds, but the Press Enter command is active for five minutes, unless another key is pressed to cancel.

Press the Enter button  to run the pump forward. When the process is complete, you will be returned to the standby screen.

GLS Compact Sampler

Section 4 Running a Program

4.1 Starting a Program

You can easily start the GLS operation by pressing the Go button . Pressing this button runs the current program.

The GLS operation can also be started with the one-button programming sequence. This action will load the stored program settings as the current settings and run the program.

Generally when you start a program, the GLS will attempt to take its first sample at the start time – unless the first sample is delayed or inhibited.

Related topics:

- Counting down program start times, section 4.2
- Sampler inhibiting, section 4.3
- Run state displays, section 4.4
- The sample collection cycle, section 4.5
- Pausing or stopping a program, section 4.6
- Post sampling activities, section 4.8

4.2 Program Start Times

After pressing the Go button , the GLS will immediately take a sample regardless of whether it is a time or flow paced program. However, the Program Start Time setting (section 3.4.3.6) can be used to start the sample collection at a later time after you press Go.

If a Program Start Time has been programmed, the GLS waits until the this time and date before drawing its first sample. While waiting the GLS display alternates between the screens below.

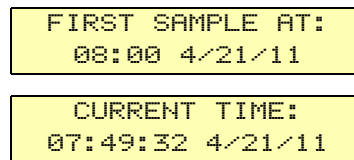

```
FIRST SAMPLE AT:  
08:00 4/21/11  
  
CURRENT TIME:  
07:49:32 4/21/11
```

4.3 Sampler Inhibit

Before the GLS takes its first sample, it checks the inhibit line of the Flow Meter connector. If the GLS detects a logic low (grounded) level, it will suspend the program until the external device returns the line to a logic high (or open) level.

While the GLS is inhibited it will display the screen below.

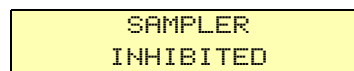

```
SAMPLER  
INHIBITED
```

The inhibit line allows an external device, while monitoring parameters of interest, to control the sampler operation. Compatible Teledyne Isco devices can be configured to inhibit a sampler until a parameter meets user-defined conditions. For example, a 4200 Flow Meter with a Model 201 pH/Temperature Module can be programmed to suspend sample collection until the stream temperature exceeds 100° F.

When the external device releases the inhibit, the GLS will:

- immediately take the first sample
- reset the time or flow pacing interval and begin counting down
- latch the inhibit signal

Latching the inhibit signal means that the GLS will ignore any later inhibit signals from an external device. Once the GLS collects its first sample, its operation will continue until the program is done.

 **Note**

The GLS will not “store” samples while it is inhibited. The GLS takes no action at all when it counts down a complete time or flow-pacing interval.

 **Note**

Sampler Inhibit signal (pin F) requirements – a low (grounded) level of at least 5 seconds inhibits the operation. A high (or open) level of at least 5 seconds in duration restores the operation.

4.4 Run State Displays

The GLS updates its display while it is running a program so that you can monitor the status. The Run State displays are listed below.

Collecting a sample –

As the GLS goes through a sample collection cycle it displays...

```
TAKING SAMPLE
xxx of yyy
```

or

```
TAKING SAMPLE
xxx
```

...where “xxx” is the current sample number and “yyy” is the programmed number of samples.

Waiting to sample –

While the GLS counts down the pacing interval it displays...

```
SAMPLE xxx of yyy  
IN mmm:ss
```

or

```
SAMPLE xxx of yyy  
IN zzz FLOW PULSE
```

...where “xxx” is the next sample number and “yyy” is the programmed number of samples. If the GLS is in the Continuous Sampling mode, it only displays the next sample number.

Errors –

If the GLS encounters an error while running a program, the following display alternates with the pacing interval countdown display:

```
ERRORS HAVE OCCURRED
```

Note

You can pause a running program to determine the type of error.

4.5 Sample Collection Cycle

Each time the GLS collects a sample (programmed or grab) it runs the pump through a complete sampling cycle. The cycle consists of three actions – Pre-purge, Fill, and Post-purge.

Pre-purge – As the GLS waits to collect a sample, some liquid will tend to enter the suction line and debris may collect around the strainer. The pre-purge runs the GLS pump in reverse to force air down through the suction line and strainer. This action will flush the water from the suction line and clear any debris near the strainer. The duration of the pre-purge is automatically calculated by the GLS based on the programmed suction line settings.

Fill – After a pre-purge, the GLS pump changes its direction to draw liquid into the suction line. The liquid travels up through the suction line and the pump tube where it then passes through the liquid detector and peristaltic pump. The liquid is transferred to the discharge tube via the bulkhead fitting. The discharge tube deposits the liquid into the bottle. The duration of the fill is controlled by the GLS using input from the programmed volume and suction line settings, and the liquid detector. The Event Mark pin of the Flow Meter connector goes to a high level (+12 Volts DC) at the beginning of the fill and remains high until the fill is complete.

Post-purge – After the fill, the GLS again reverses the pump direction to force air down through the suction line. This action clears the entire liquid path to prevent cross-contamination. During the post-purge, the GLS will determine if the bottle is full. Since a short length of discharge tube extends inside the bottle, an over-filled bottle will allow liquid to be drawn back into the discharge tube. If the liquid detector finds that this excess amount of liquid is being returned through the liquid path, the GLS stops the program and indicates that the bottle is full. The duration of the post-purge is automatically calculated by the GLS based on the programmed suction line settings.

4.6 Pausing or Stopping a Program

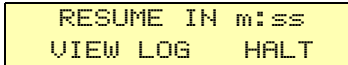

Press the Stop button  to pause a running program. The GLS will display the paused options screen.



```
RESUME IN m:ss
VIEW LOG  HALT
```

The screen displays three options – Resume, View Log, and Halt.

- Resume – select this option to return to the running program. When the GLS enters the paused state, it starts a five-minute idle time-out. If you do not press a button within five minutes, the GLS will automatically resume the running program.
- View Log – select this option to scroll through the log.
- Halt – select this option to stop the program. Once you stop a program, it cannot be resumed. To run a program the GLS must be restarted.

Use the Arrow button  to select an option. When the desired option is blinking, press the Enter button .

Note

The GLS continues to count down the pacing interval while it is paused. Keep in mind that if the count reaches zero the GLS will not take a sample. It records this as a “MISSED SAMPLE – PROGRAM PAUSED” in the log.

4.7 Program Completion

A running program will end in one of three ways:

- Program Completed – The GLS has taken all of the programmed samples.
- Program Halted – Stopped by the user.
- Bottle Full – The GLS detected a full bottle and stopped the program.

4.8 Post-sampling Activities

Typical post-sampling activities include:

- Recovering the sampler
- Viewing the log
- Preparing the sample bottle to return to the lab
- Preparing the GLS for reuse

4.8.1 Recovering the Sampler

When the GLS completes the program, it often must be retrieved and placed in a location that allows you easily gain access to its contents. If you must move the sampler keep the following in mind:

- A GLS with battery, full sample bottle, and ice may weigh as much as 63 pounds (28.6 kg).
- The GLS must be kept level to avoid spilling the bottle's contents.

4.8.2 Preparing the Full Sample Bottle

To prepare a full bottle to return to the lab you must first gain access to the sampler's base. To open the sampler:

1. Place the sampler on a level surface.
2. Rotate the carrying handle from its secured (vertical) position to its open (horizontal) position. Unlock the handle if necessary.
3. Release the two latches that fasten the center section to the base section.
4. Lift the center section from the base and set the center section aside.

Now that you have gained access to the bottle, place a cap on it. Then, lift the bottle out of the base. At this point, it is a good idea to label the bottle with the time, date, and site, along with other pertinent information.

4.8.3 Log

The log is a recorded history of the last or currently running program. The GLS records key program events, such as start and stop times, and exceptional events, such as power failures or missed samples.

The log can be viewed by selecting the "VIEW LOG" option at the Standby or Paused state displays.

As you begin to view the Log, the GLS reports the following:

- The number of samples it has collected
- Missed samples. The GLS skips this display if there are none to report. If there are, the GLS will report the number of samples missed and the cause. Possible causes are:
 - No liquid detected
 - No more liquid
 - Power fail
 - User stopped pump
 - Paused
 - Pump jammed
 - Program halted
 - Bottle full
- Program start time
- Current status. One of the following will be reported:
 - Program completed

- Program halted
- Bottle full
- Program paused (with number of samples remaining)
- Power lost. If power was lost while the GLS was running the program, it reports the times it was lost and restored. This will be reported whether a sample was missed or not.
- Last sample volume calibration date
- Last programmed date
- Clock set at (time and date)
- Sampler ID and software revision number
- Pump tube warning if the pump counts exceed 500,000. When the GLS displays this message, replace the pump tube to prevent failures. The GLS automatically resets the pump count to zero after displaying this message.

 **Note**

Pressing the Go button clears the log. The only information that the GLS retains from program to program is the Last Calibration Date, Last Programmed Date, Clock Set, and the Sampler ID and Software Revision. The GLS also keeps the current pump count value which is used to determine when to display the pump tube warning. Re-initializing the GLS or updating the software will also clear the log.

4.8.4 Errors

The GLS can detect program errors or conditions that have caused it to miss a sample. If the GLS encounters an error condition and is still running a program, it alternates the message below with the current display.

The GLS also makes an entry in the Log, which can be viewed later to determine the cause. Possible log entries are:

- **No liquid detected** – The GLS did not detect any liquid.
- **No more liquid** – The GLS did detect liquid during the fill cycle, but it stopped detecting liquid before a complete sample volume was collected.
- **Power fail** – Power was lost and caused the GLS to miss a sample.
- **User stopped pump** – The user pressed the Stop button while the GLS was collecting a sample.
- **Paused** – The GLS was in the paused state when a sample was to have been initiated.
- **Pump jammed** – The GLS pump jammed during a sample collection cycle.
- **Program halted** – Remaining samples were not collected because the program was halted.

- **Bottle full** – Remaining samples were not collected because the GLS detected a full bottle.

4.9 Grab Samples

Grab samples let you take a single sample on demand, collecting the sample in an external container. You can collect a grab sample while the GLS is running a program, paused, or in standby.

To collect a grab sample:

1. Press the Grab Sample button .
2. The GLS asks how much liquid to collect. Using the number-entry buttons, enter the desired volume (in ml). Press the Enter button to continue.
3. The GLS waits for you to prepare to collect a grab sample. Pull the lower pump tube from the bulkhead fitting. Hold the end of the tube over a container. Press the Enter button when you are ready.
4. The GLS goes through a complete sample collection cycle and deposits the requested amount of liquid in the container.
5. Return the pump tube to the bulkhead fitting.

```
SAMPLE VOLUME
200 ml (10-9990)
```

```
GRAB SAMPLE
PRESS ← WHEN READY!
```

```
TAKING 200 ml
GRAB SAMPLE
```

Note

If a grab sample is taken while a program is running, it is not counted as part of the number of samples.

Note

If you interrupt a running program to collect a grab sample and miss a programmed sample event, it is logged as “PROGRAM PAUSED” error.

GLS Compact Sampler

Section 5 Servicing the Sampler

5.1 Servicing the Sampler This section contains instructions necessary to perform routine and preventive maintenance on the GLS and its related components. The topics are outlined below.

Routine maintenance — at user determined intervals

- Cleaning
- Pump tube replacement, section 5.2.2.
- Discharge tube replacement, section 5.2.3.
- Battery and power pack servicing, section 5.2.4.

Preventive maintenance — as needed

- Replacing the internal desiccant, section 5.3.1.
- Renewing the desiccant, section 5.3.2.

Problem resolution

- Troubleshooting and self-diagnostics, section 5.4.1.
- Contacting Teledyne Isco for assistance, section 5.4.2.
- Return instructions, section 5.4.3.
- Replacement parts, Appendix A

5.2 Routine maintenance

5.2.1. Cleaning

This section contains topics that provide instructions for cleaning the GLS and its components. topics included are:

- Cleaning the GLS case and controller
- Cleaning the bottles
- Cleaning the suction line, strainer, and tubing.
- Cleaning protocols for priority pollutants and critical sampling. This topic may be used as a guide to develop cleaning methods for equipment engaged in regulatory compliance monitoring.

5.2.1.1 Cleaning the GLS

The GLS controller, top cover, center section, base, and bottle deck can be cleaned with warm soapy water or by spraying them with a hose. Avoid using a high-pressure hose to clean the controller. Extreme pressures may damage the label or force water past the control panel seal.

The connectors should be protected when you are cleaning the controller. Cap the Flow Meter connector with the attached cap. Keep a power source connected to protect the 12V Input Power connector, or use the protective cap that was in place when the unit was shipped.

5.2.1.2 Cleaning the Bottles

The bottles have a wide mouth to facilitate cleaning. Wash them with a brush and soapy water, or use a dishwasher. Glass bottles may be autoclaved.

The 2 gallon (7.6 liter) ProPak™ system was developed by Teledyne Isco to offer the greatest convenience in preparing sample containers for re-use. Simply remove the used liner and place a new one in the holder. Used ProPak liners can be disposed of or recycled. When necessary, the holder can be washed with warm soapy water or placed in a dishwasher.

5.2.1.3 Cleaning the Suction Line and Tubing

The suction line, pump tube, and discharge tube can be cleaned by placing the end of the suction line in a cleaning solution. Press the Grab Sample button to pump the solution through the delivery system. When the delivery system is clean, repeat the pumping with clean water to rinse the lines. If any of these items are severely contaminated, they should be replaced.

The strainer can be cleaned with a brush and soapy water.

5.2.1.4 Cleaning Protocols for Priority Pollutants

Clean sampling equipment is essential for valid laboratory analysis. Teledyne Isco recommends that you develop cleaning protocols in consultation with a laboratory analyst when designing the monitoring program. For example, to clean sample bottles, suction line, and pump tubes, Lair (1974) suggests these protocols used by USEPA Region IV Surveillance and Analysis field personnel engaged in NPDES compliance monitoring. The protocols are based on U.S. Environmental Protection Agency Publications EPA-600/4-77-039 (Sampling of Water and Wastewater by Dr. Phillip E. Shelley).

Teledyne Isco Glass Sample Bottles –

1. One spectro-grade acetone rinse.
2. Dishwasher cycle (wash and tap water rinse, no detergent).
3. Acid wash with at least 20 percent hydrochloric acid.
4. Dishwasher cycle (wash and tap water rinse, no detergent).
5. Replace in covered Teledyne Isco tubs.

Vinyl Suction Line –

Use new suction line for each new sampling setup, therefore, no cleaning is required. When sampling for organic compounds, use PTFE suction line.

PTFE Suction Line –

1. Rinse twice with spectro-grade acetone.
2. Rinse thoroughly with hot tap water using a brush, if possible, to remove particulate matter and surface film.
3. Rinse thoroughly three times with tap water.
4. Acid wash with at least 20 percent hydrochloric acid.
5. Rinse thoroughly three times with tap water.
6. Rinse thoroughly three times with distilled water.
7. Rinse thoroughly with petroleum ether and dry by pulling air through the line.

8. Dry overnight in a warm oven (use an oven temperature of lower than 150° F), if possible.
9. Cap ends with aluminum foil.

Teledyne Isco Pump and Discharge Tubes –

1. Rinse by pumping hot tap water through the tube for at least 2 minutes.
2. Acid wash the tube by pumping at least a 20 percent solution of hydrochloric acid through the tube for at least 2 minutes.
3. Rinse by pumping hot tap water through the tube for at least 2 minutes.
4. Rinse by pumping distilled water through the tube for at least 2 minutes.

 Note

For critical sampling applications, consider replacing the suction line, pump tube, and discharge tube. Replacement eliminates the possibility of any cross contamination from previous sampling sites.

5.2.2. Replacing the Pump Tube

The pump tube is subject to wear during pump operation. It should be replaced when the GLS displays the pump tube warning at 500,000 pump counts, or when inspection of the tube reveals any cracks along its side. The pump counter should be reset at this time.

 Note

The importance of regular tubing replacement cannot be overstated. The key is to replace the tube before failure, not after. When a pump tube ruptures, grit and other abrasive debris can be driven into the pump shaft seal. Over time, this abrasive material will degrade the pump seal, jeopardizing the NEMA 4x 6 rating of the controller.

Failure to maintain the pump tube may result in permanent damage to the sampler. Check the condition of the pump tube regularly and if the tube shows signs of fatigue or wear, replace it immediately. A properly maintained sampler will provide the years of reliable service that is expected of a Teledyne Isco Sampler.

 WARNING
--

Pump may actuate without warning. To avoid injury, sampler must be off when pump housing cover is removed for inspection or tubing replacement.

To remove the pump tube:

1. Disconnect the power from the 12V Input Power connector.
2. Disconnect the suction line and pull the pump tube from the bulkhead fitting.
3. Loosen the two thumbscrews and remove the liquid detector cover.
4. Loosen the four thumbscrews and remove the pump housing cover.
5. Pull the pump tube out of the pump housing. Rotating the pump rollers will help free the tube.
6. Clean the inside of the pump housing if necessary.

Note

Teledyne Isco replacement pump tubes are marked with two black bands. These bands are used to correctly locate the tubing in the liquid detector and the pump. Position the pump inlet, or short end, in the upper groove of the liquid detector. The band should be placed at the outer edge of the liquid detector.

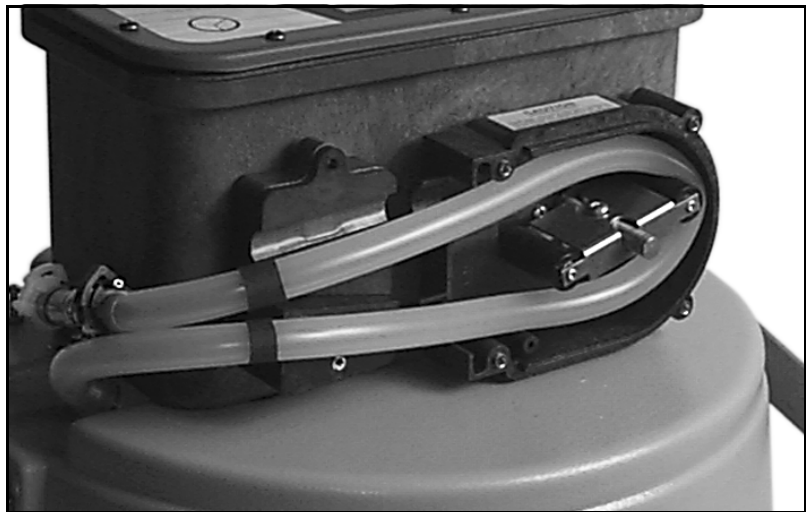

Figure 5-1 Liquid detector and pump housing covers removed

To replace the pump tube:

1. Slip the pump tube under the pump rollers. Rotating the rollers as you do this will help to slide the tube into the pump.
2. Position the pump tube by aligning the bands at the outer edge of the liquid detector.
3. Replace the liquid detector and pump housing covers. The thumbscrews should be fully hand-tightened.
4. Connect the pump outlet end to the bulkhead fitting. Connect the suction line to the pump inlet.
5. Reconnect the power.

To reset the pump counter:

1. In Standby state, press 6398823 (NEWTUBE) on the keypad.
2. From the display SELECT PUMP COUNTER?, select YES.

Note

Replacement pump tubes, P/N 60-2954-030, are available from Teledyne Isco.

Note

If you are cutting replacement tubes from bulk Silastic tubing, cut the length to 27.75 inches (705 mm). Since the bulk tubing will not have bands to mark the correct position, ensure that 18.25 inches (490 mm) of tubing is inside the liquid detector and pump, and that the tube is not kinked where it fits over the bulkhead fitting.

Note

The factory set value of 500,000 pump counts will deliver approximately 500 samples of 200 ml each, using a $\frac{3}{8}$ -inch by 10-foot suction line at a 5-foot suction head.

Note

The peristaltic pump and tube will perform the best when you:

- Use Teledyne Isco replacement pump tubes or bulk tubing.
- Install the tube properly, aligning the inside edges of the bands with the outside edges of the liquid detector.
- Follow the natural curve of the pump tube when fitting the tube inside the pump housing.
- Use the shortest possible length of suction line.

5.2.3. Replacing the Discharge Tube

The discharge tube does not “wear out” under normal circumstances. However, some sampling protocols may require new tubing, or that the tubing be cleaned, before running each program.

To replace the discharge tube:

1. Remove the two thumbscrews that secure the discharge tube guide.
2. Lift the discharge tube guide and pull the tube off of the bulkhead fitting.
3. Slide the old tube out of the guide.
4. Insert the replacement tube. Replacement tubes should be a $\frac{3}{8}$ inch (9 mm) I.D., 8 $\frac{1}{4}$ inch (210 mm) long piece of Silastic™ tubing, available from Teledyne Isco (P/N 60-2953-032).

5. Push the end of the new discharge tube onto the bulkhead fitting.
6. Properly position the tube guide and tighten the two thumbscrews.
7. Adjust the tube so that 1½ inches (38 mm) of tubing extends beyond the end of the tube guide. This length of tubing is necessary for the GLS to detect an overfilled bottle.

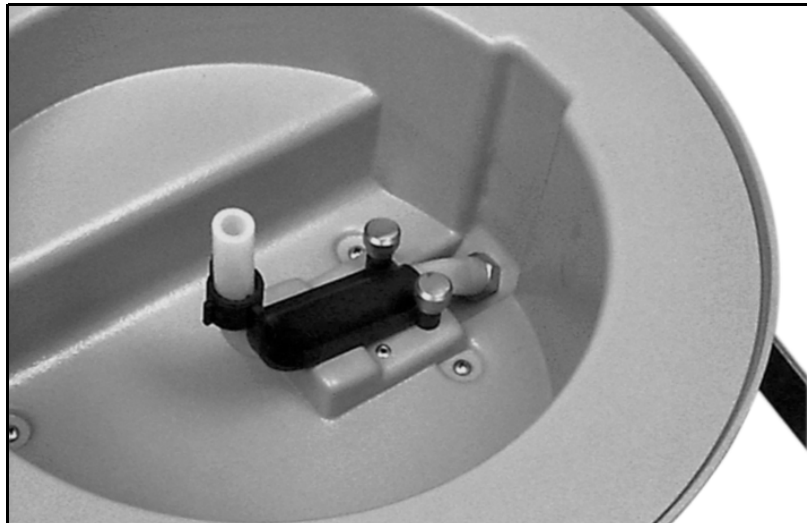

Figure 5-1 Discharge tube and tube guide

5.2.4. Servicing Batteries and Power Packs

If you are using a battery to power the GLS, Teledyne Isco recommends that you install a freshly charged battery before starting each program. Refer to the Power Products Guide for instructions on servicing Teledyne Isco power packs and batteries.

5.3 Preventive maintenance

5.3.1. Replacing the Internal Desiccant

The GLS uses a bag of desiccant to protect its internal components from moisture damage. When the internal case humidity exceeds 30%, the desiccant should be replaced. The internal case humidity is shown on the indicator visible through the front panel label. The indicator turns pink or white when the humidity level exceeds the printed value. Ideally, all three sections of the indicator should be blue.

If the 20 and 30% sections are pink or white, replace the desiccant.

1. Disconnect the power from the 12V Input Power connector.
2. Remove the 10 screws that attach the GLS front panel and bezel.
3. Remove the bezel.

 **CAUTION**

The GLS controller contains electronic circuitry that can be damaged by static discharge. Open the controller only in a static-free environment.

4. Lift the front panel slowly so that the connecting wires are not pulled excessively.
5. While holding the front panel up, open the cardboard box and remove the bag of desiccant. Do not try to remove the cardboard box – it is firmly attached to the side of the case. Attempting to remove the box may damage the box.
6. Insert a new or renewed bag of desiccant.
7. Visually inspect the internal components. Corrosion, residue, or other evidence of moisture damage will indicate a need for cleaning or repair. Contact Teledyne Isco for assistance.
8. Inspect the front panel gasket. It should fit properly in the case and its surface should be clean and smooth.
9. Replace the front panel using care to ensure that the wiring will be free of the gear train.
10. Replace the bezel and screws. Tighten the 10 screws in an even, cross-torquing pattern.

The internal humidity indicator should return to its normal blue color in a few hours.

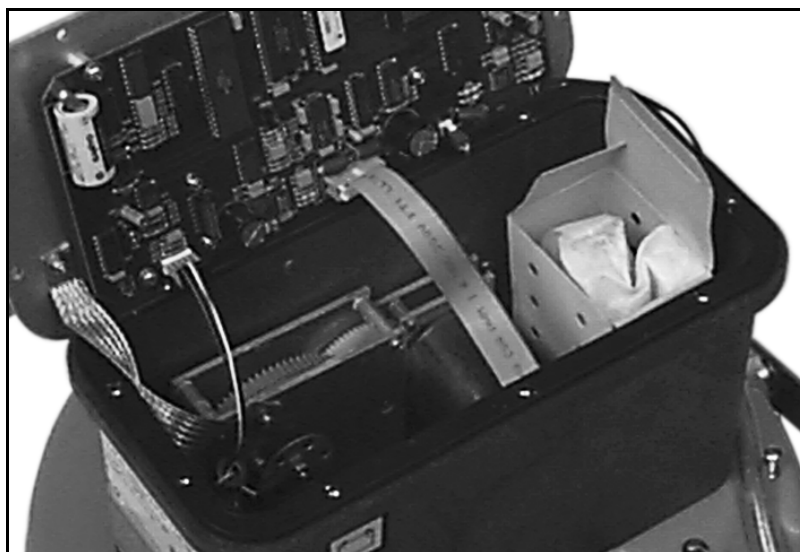

Figure 5-1 Internal Desiccant

5.3.2. Renewing the Desiccant

 **CAUTION**

Desiccant may produce irritating fumes when heated. We urge you to use caution when working with desiccant. Material Safety Data Sheets are located in Appendix B. To reduce the hazard of the fumes:

- Use a vented oven in a well-ventilated room.
- Do not remain in the room while recharging is taking place.
- Use the recommended temperature.

 **CAUTION**

There have been reports of irritating fumes coming from the desiccant during reactivation. While our attempts to duplicate the problem have been unsuccessful, we still urge you to use caution. Material Safety Data Sheets are located at the end of this manual.

To renew the desiccant:

1. Remove the bag from the GLS controller.
2. Place a sheet of brown paper on a flat metal sheet. You can use a brown grocery bag and a typical cookie sheet.
3. Place the bag on the sheet. If you are recharging several bags, do not stack the bags on top of each other or allow them to touch.
4. Place in a vented, circulating forced air, convection oven in a well-ventilated room. Allow two inches of air space between the top of the bag and the next rack. Keep the tray a minimum of 16 inches from the heating element.
5. Heat the bag at a temperature of 240 to 250° F (116 to 121° C) for 12 to 16 hours.
6. At the end of the time period, the bag should be immediately removed and placed in an airtight container for cooling.
7. When the bag has cooled to room temperature, it may be returned to the GLS controller.

The desiccant will be recharged to approximately 80 to 90% of its previous capacity. After repeated renewing, the desiccant bag may require replacement.

Some bags will have the temperature and time for renewing the desiccant printed on the bag. If they differ, use the temperature and time printed on the bag.

5.4 Diagnostics and Repair

5.4.1. GLS Self-diagnostics

If you are experiencing problems with the GLS, contact Teledyne Isco's Repair Service Department. Simple difficulties can often be diagnosed over the telephone. Before contacting Teledyne Isco however, take a few moments to ensure that several common problems are first eliminated.

- Ensure that the power supply is adequate. Low power can cause a variety of problems. Simply replacing the battery with a freshly charged unit, or replacing the power pack can correct many faults.
- Ensure that the liquid delivery system is in good condition. The tubing should be free from leaks caused by pinholes or cracks. Ensure that the tubing is not plugged by debris.
- Clear debris away from the end of the strainer and ensure that it is submerged deep enough to supply liquid for the entire fill portion of the sampling cycle.

If the cause of the problem cannot be determined, the GLS self-diagnostics routine can be used to test the sampler's functions.

To run the basic level diagnostics:

1. Press **3 4 2 4 ←** at the Standby display. The GLS enters the diagnostics mode.
2. The GLS tests the RAM (Random Access Memory). The GLS displays the RAM test results for four seconds then advances to the next test. If the GLS reports "RAM TEST FAILED" contact Teledyne Isco. RAM stores program settings, log data, internal counters, pump tables, etc.
3. The GLS tests the ROM (Read Only Memory). The GLS displays the ROM test results for four seconds and then advances to the next test. If the GLS reports "ROM TEST FAILED" contact Teledyne Isco. ROM stores the embedded software.
4. The GLS tests the liquid crystal display (LCD). The cursor moves across the LCD turning on every pixel, then turning off every pixel. Next, the GLS displays characters on the display. Contact Teledyne Isco if the pixels or characters do not appear correctly.
5. The GLS queries "TEST PUMP?". Use the Arrow button to choose an option and press the Enter button to select it. Select "NO" to skip the pump test and advance to the next test. Select "YES" and the GLS runs the pump in both directions – pumping and purging. At the end of each direction, it displays an On/Off ratio. This ratio should be between 0.50 and 2.00. Contact Teledyne Isco if the ratio is outside of this range. A count near 1.00 is typical.
6. The GLS queries "TEST LIQUID DETECT?". Use the Arrow button to choose an option and press the Enter but-

ton to select it. Select “NO” to skip the liquid detect test and advance to the next function (step 9). Select “YES” and the GLS enters the liquid detector test.

7. (Liquid Detector Test, continued) The GLS displays “LIQUID DETECT TEST: PRESS ↵ WHEN READY.” Ensure that the end of the suction line is in water and there is something to catch the liquid if it is discharged from the pump. Press the Enter button when you are ready.
8. (Liquid Detector Test, continued) The GLS pumps liquid and attempts to detect the liquid in the pump tube. It reports “LIQUID DETECT RINSE (#)” as each of the five rinse cycles are accomplished. When the GLS does not detect liquid it reports the reason and waits for a response. At this point you should:
 - Verify that liquid was present in the pump tube during the pumping.
 - Verify that the pump tube is installed correctly. The inside edges of the black bands should be even with the outside edges of the liquid detector.
 - Ensure that the liquid detector cover is firmly seated over the pump tube and the thumbscrews are tight.

After checking the items above, rerun the liquid detect test by pressing any button (except the Stop and On/Off) to return to step 6. If the above steps did not remedy the problem, contact Teledyne Isco. If you press the Stop button, the GLS skips the liquid detector test and advances to step 9.

9. The GLS queries “RE-INITIALIZE?”. Re-initializing the GLS resets the stored and current program settings to the factory defaults and clears the log. To skip the reset, select “NO” and the GLS returns to the Standby state. To reset the program settings, select YES. The GLS will ask if you are sure. Select YES and the GLS will load the default settings and turn itself off.

5.4.2. Contacting Teledyne Isco for Assistance

Contacting Teledyne Isco:

Teledyne Isco, Inc.

P.O. Box 82531

Lincoln, Nebraska 68501 USA

Phone: (402) 464-0231

USA & Canada: (866) 298-6174

Fax: (402) 465-3022

E-mail: Product Information: IscoInfo@teledyne.com

Technical Service: IscoService@teledyne.com

World Wide Web: <http://www.isco.com>

5.4.3. Return Instructions

Should it become necessary to return the GLS to the factory for repair, please contact Teledyne Isco first and obtain a Return Authorization Number (RAN). This will aid in the prompt repair and return of the sampler.

When returning the GLS, the unit should be thoroughly cleaned and packed in the original shipping containers. If the original container is not available, prepare the sampler as described below.

1. Remove the suction line, strainer, and bottle from the sampler.
2. Assemble all of the remaining components, latching the sections together.
3. Place the sampler in a bag.
4. Select a cardboard box at least 6 inches (150 mm) longer in each dimension.
5. Place the sampler in the box.
6. Fill the box equally with resilient packing material (shredded paper, bubble pack, expanded foam pieces, etc.).
7. Include a note describing the malfunction or reason for return, and reference the RAN.
8. Seal the box and ship to the address listed below.

Consulting with Teledyne Isco's Repair Service Department will often determine that only the GLS controller requires servicing. The controller can be removed and shipped without the top cover, center section, and base to save freight charges. To remove the controller and ship it:

1. Disconnect the suction line from the pump tube.
2. Disconnect the pump tube from the bulkhead fitting.
3. Disconnect any items connected to the 12V Input Power and Flow Meter connectors. Place the cap on the Flow meter connector port.
4. Release the two latches holding the center section and base together.
5. Turn the center section over and remove the four screws that mount the controller.

6. Place the controller in a bag.
7. Place the controller in a box at least 6 inches (150 mm) longer in each dimension and fill the box equally with resilient packing material.
8. Include a note describing the malfunction or reason for return, and reference the RAN.
9. Seal the box and ship to the address listed below.

Shipping address:

Teledyne Isco, Inc.
4700 Superior Street
Lincoln, Nebraska, USA 68504

<input checked="" type="checkbox"/> Note

Your warranty, found in the back of this manual, describes conditions under which Teledyne Isco will pay surface shipping costs.

GLS Compact Sampler

Section 6 GLS Options

Several software-based options are available for the GLS.

- Program Lock – adds password protection to sampler programming and operation.
- Program Storage – store a program for easy recall.
- Bottle Full Disable – turn off full bottle detection when using $\frac{3}{8}$ inch (9 mm) suction lines.
- Liquid Detector Disable – turn off the liquid detector for difficult sampling applications.
- Foreign Languages – The GLS can be shipped with foreign language displays.

6.1 Program Lock

The Program Lock adds password protection to the sampler operation. When the Program Lock is enabled, you must enter a password before entering the programming mode and before pausing or halting a running program.

The Program Lock is a **factory-installed option**. This option should be specified at the time of ordering, or you can return the controller to Teledyne Isco to have the option installed.

When the Program Lock function is installed, the LOCK option appears on the Standby display.



The LOCK option on the Standby display allows you to enable or disable the password protection and to change the password. A review of the LOCK option displays appears below.

```
PROGRAM   VIEW LOG
hh:mm ddmmmyy LOCK
```

```
ENTER PASSWORD
XXXXXX
```

```
USE PROGRAM LOCK?
YES  NO
```

```
CHANGE PASSWORD
YES  NO
```

1. Press the Arrow button  until “LOCK” is blinking.
2. Press the Enter button  to accept the selection.
3. If the Lock is currently enabled you will be asked to enter the password before modifying any settings. The GLS is shipped from the factory with a default password of “457.” Press the number buttons to enter the password and the display returns an asterisk for each button pressed. Press the Enter button to continue.
4. The next display allows you to enable or disable the password protection. Selecting YES turns the password protection on and advances to step 5. Selecting NO turns the protection off and the GLS returns to the Standby state.
5. The GLS queries “CHANGE PASSWORD?”. If you select YES the GLS advances to the password entry displays in steps 6 and 7. If you select NO, the GLS retains the existing password and returns to the Standby state.

ENTER NEW PASSWORD

REENTER PASSWORD

6. Use the number-entry buttons to enter the new password. A valid password uses any combination of numbers 0 through 9. The password can use as many as five digits. As you enter the numbers, the GLS displays asterisks to “hide” the password. Press the Enter button to accept the password and advance to step 7.
7. The GLS asks you to confirm the password by re-entering it. Again, use the number-entry buttons to enter the password and then press the Enter button to accept it. When you successfully confirm the password, the GLS returns to the Standby state. If the confirmation is unsuccessful, the GLS notifies you that the passwords are different and returns you to step 6.

Note

While a program is running, it is possible to halt the operation of the pump without the password. Pressing the Stop button will halt the current sample and prompt you to ENTER PASSWORD. Entering the correct password places the GLS in the Paused state. If the password is incorrect, or if there is no password entered within 60 seconds, the sampler resumes the count down to the next sample. In any case, the GLS logs the missed sample as USER STOPPED PUMP.

Note

Any samples that would have been taken while the sampler is waiting for password entry will be logged as missed due to PROGRAM PAUSED.

6.2 Storing a Program

GLS is shipped with default program settings as its stored program. You can overwrite the stored program settings with your own program by using the Program Store function.

To store a program:

1. Modify the current program using the standard programming.
2. Press **7 8 6 7 3**  while in the Standby state. The GLS displays “PROGRAM STORED” for four seconds.

The current program settings are now saved in the GLS memory as the Stored Program. In the field, recall and run the program with the One-button programming procedure.

Note

The stored program settings are held in the sampler’s memory until the software is updated or the GLS is re-initialized. Either of these actions will restore the factory default program settings.

6.3 Disable Bottle Full Detection

```
BOTTLE FULL DETECT?  
YES NO
```

The bottle full detection feature can be disabled.

To disable the bottle full detection:

1. Press **3 8 5 5** **←** while in the Standby state.
2. The GLS displays “BOTTLE FULL DETECT?”. Select NO to disable bottle full detection. Select YES to use bottle full detection.
3. Press the Enter button to accept the blinking option and the GLS returns to the Standby state.

Note

Bottle full detection is always disabled when using ¹/₄ inch (6 mm) suction line.

6.4 Liquid Detector Disable

```
USE LIQUID DETECTOR?  
YES NO
```

It is possible to disable the operation of the liquid detector. Typically, there are only two applications where this may be beneficial – collecting samples that include a large amount of foam, or collecting samples from pressurized lines.

Keep in mind that disabling the liquid detector will affect the sample collection in several ways. The most significant effect is the sample volume accuracy. Although you can calibrate the sample volumes at a fixed suction head, the GLS will be unable to compensate for varying stream levels. Secondly, the GLS will not be able to detect a full bottle. A disabled liquid detector may increase the risk of overflowing the bottle. Lastly, the GLS will not be able to detect and log missed samples caused by NO LIQUID or NO MORE LIQUID.

To disable the liquid detector:

1. Press **5 3 9 0** **←** while in the Standby state.
2. The GLS displays “USE LIQUID DETECTOR?”. Select NO to disable the liquid detector. Selecting YES restores the operation.
3. Press the Enter button to accept the blinking option and the GLS returns to the Standby state.

6.5 Pressurized lines

The sampler can obtain samples from pressurized lines, as long as the line pressure does not exceed 15 psi (pounds per square inch). Pressures greater than 15 psi may prevent the sampler from purging the suction line; moreover, extreme pressures can force liquid past the pump, even when the pump is not running.

Teledyne Isco does not recommend sampling from pressurized lines.

6.6 Foreign Language Displays

The GLS is shipped with English language displays unless a different language is specified at the time of ordering. Other available languages are listed below:

- English 3645474
- French 373624
- German 437626
- Italian 4825426
- Spanish 7726474
- Japanese 52726
- Swedish 7933474
- Czech 20324

To change the display language, type the numeric code using the keypad, then press ENTER.

Other languages may be available. Contact the factory for more information.

6.7 Software Updates

Teledyne Isco will at times release updated versions of software.

The GLS uses Flash memory to store its software. With Flash technology you can upgrade your sampler's software without sending it back to the factory or replacing a chip.

The software is updated by transferring a binary file (.BIN) from a PC to the GLS. This requires the new binary file, a PC-to-GLS connect cable (Teledyne Isco P/N 60-2954-021), and a program running on your PC. Teledyne Isco has three software programs that may be used to update the instrument software – Flowlink™ 3, Update Software (shipped with Flowlink 4 for Windows), and Flash Update.

<input checked="" type="checkbox"/> Note

When connecting to the GLS, a baud rate of 19,200 is recommended.

6.8 Accessories

Order Information:

Prices are available upon request. To order any item, contact your sales representative or Teledyne Isco. You may note that the part name listed on your order acknowledgment and invoice and may be different than the name listed here. When examining these documents, use the part number for reference.

Bottles

- 68-6700-020 1 gallon polyethylene round bottles with caps, qty 4
- 68-2910-004 1 gallon glass round bottle with cap and liner, qty 1
- 68-6700-021 1 gallon glass round bottles with caps and liners, qty 4

- 299-0013-04 2.5 gallon polyethylene round bottle with cap, qty 1
- 68-2700-005 2.5 gallon glass round bottle with cap and liner, qty 1

General Accessories

- 60-2954-030 Pump tube, GLS, 27.75 inches long
- 60-6700-046 Silastic pump tubing, bulk 10' length, for pump and discharge tubes
- 60-6700-047 Silastic pump tubing, bulk 50' length, for pump and discharge tubes
- 299-0020-00 Plastic graduated cylinder, 1000 ml, for sample volume calibration
- 60-2954-033 Suspension Harness Assembly, GLS

Suction line and strainers

- 69-9004-378 $\frac{3}{8}$ " ID \times 10' vinyl suction line with standard weighted polypropylene strainer
- 69-9004-379 $\frac{3}{8}$ " ID \times 25' vinyl suction line with standard weighted polypropylene strainer
- 60-1683-146 $\frac{3}{8}$ " ID \times 10' PTFE suction line with protective coating, without strainer
- 60-2703-114 $\frac{3}{8}$ " ID \times 25' PTFE suction line with protective coating, without strainer
- 60-9004-367 $\frac{3}{8}$ " Standard weighted polypropylene strainer
- 69-2903-139 $\frac{1}{4}$ " Stainless steel low flow strainer only
- 69-2903-138 $\frac{3}{8}$ " Stainless steel low flow strainer only
- 60-3704-066 Weighted strainer only, $\frac{3}{8}$ ", CPVC body
- 68-1680-055 $\frac{1}{4}$ " ID vinyl tubing, bulk 100'
- 68-1680-056 $\frac{1}{4}$ " ID vinyl tubing, bulk 500'
- 68-1680-057 $\frac{1}{4}$ " ID vinyl tubing, bulk 1000'
- 68-1680-058 $\frac{3}{8}$ " ID vinyl tubing, bulk 100'
- 68-1680-059 $\frac{3}{8}$ " ID vinyl tubing, bulk 500'
- 69-4703-154 $\frac{1}{4}$ " Vinyl tubing coupler
- 69-4703-106 $\frac{3}{8}$ " Vinyl tubing coupler

Power Sources

- 60-1684-088 Model 913 High Capacity Power Pack (120-volt)
- 60-3004-130 Model 914 Battery-Backed Power Pack (120-volt)
- 60-1684-093 Model 923 High Capacity Power Pack (240-volt)

- 60-3004-160 Model 924 Battery-Backed Power Pack (240-volt)
- 60-1684-040 Model 934 Nickel-Cadmium Battery
- 60-3004-106 Model 946 Lead-Acid Battery
- 60-3004-059 Model 961 Battery Charger (120-volt)
- 68-3000-965 Model 965 Five Station Battery Charger (120/240-volt), with 120-volt cord
- 68-3000-966 Model 965 Five Station Battery Charger (120/240-volt), with 240-volt cord
- 60-1394-023 Connect cable, for external 12 VDC power source; terminates in heavy duty battery clips

Connect Cables and Interfaces

- 60-1644-000 Model 1640 Liquid Level Actuator
- 60-3004-107 Connect cable, 25', Teledyne Isco sampler to Teledyne Isco flow meter
- 68-1680-060 Connector only, without cable, for use with non-Teledyne Isco flow meters having an isolated contact closure proportional to flow
- 60-1394-077 Same as above, with 22' cable terminating in two wires
- 60-2004-260 2100 Series Sampler Interface Cable
- 60-3704-075 4-20 mA Sampler Input Interface (converts analog signal flow meter output as specified by user into pulses acceptable to Teledyne Isco samplers)
- 60-2954-021 Software Upgrade Cable, PC-to-GLS

GLS Compact Sampler

Appendix A Replacement Parts

Prices are available upon request. To order any item, contact your sales representative or Teledyne Isco. You may note that the part name listed on your order acknowledgment and invoice and may be different than the name listed here. When examining these documents, use the part number for reference.

Replacement parts are called out in the following illustrations. Refer to the tables to determine the part number for the item.

Replacement parts can be purchased by contacting Teledyne Isco's Customer Service Department.

Teledyne Isco, Inc.

Customer Service Department

P.O. Box 82531

Lincoln, NE 68501 USA

Phone: (800) 228-4373

(402) 464-0231

FAX:(402) 465-3022

E-mail: IscoInfo@teledyne.com

GLS Compact Sampler
Appendix A Replacement Parts

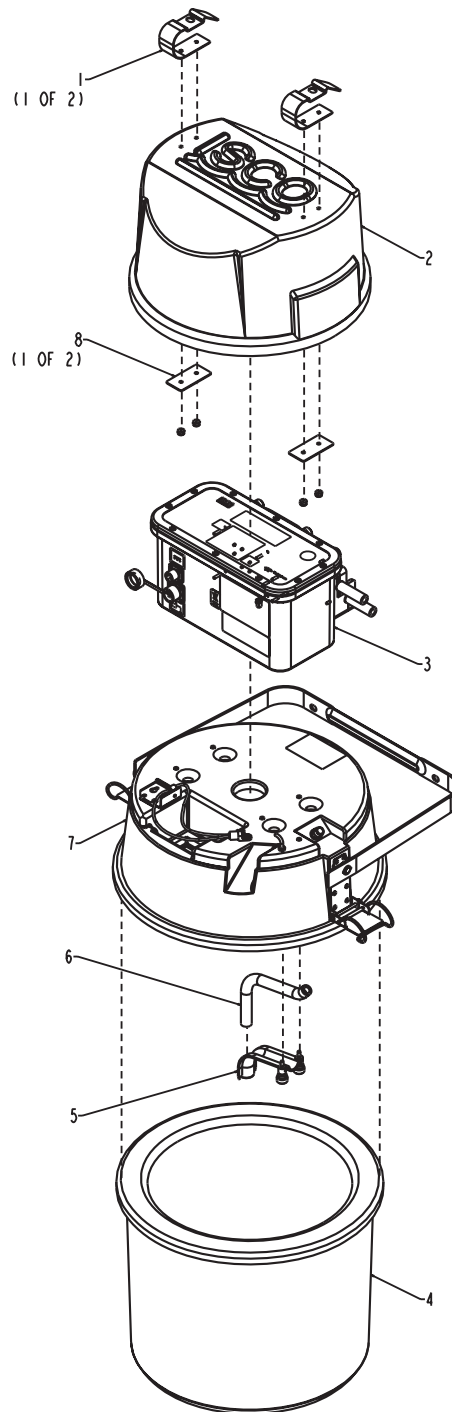

Flat Washer, #6,
Lock Washer, #6,
Screw, 8-32 x 3/4
(4)
For mounting control-
ler to center section.

ITEM	INVENTORY NO.	DESCRIPTION
1	602954022	HANDLE LATCH ASSEMBLY
2	602954018	TOP COVER ASSEMBLY (INCLUDES ITEMS 1 & 8)
3	602954001	GLS SAMPLER CONTROLLER
4	602914010	BASE ASSEMBLY
5	602954029	TUBE GUIDE ASSEMBLY
6	602953032	GLS DISCHARGE TUBE, 8.25 INCH
7	602954019	CENTER SECTION ASSEMBLY
8	602953022	HANDLE LATCH BACKUP PLATE

602953043.DRW REV. J

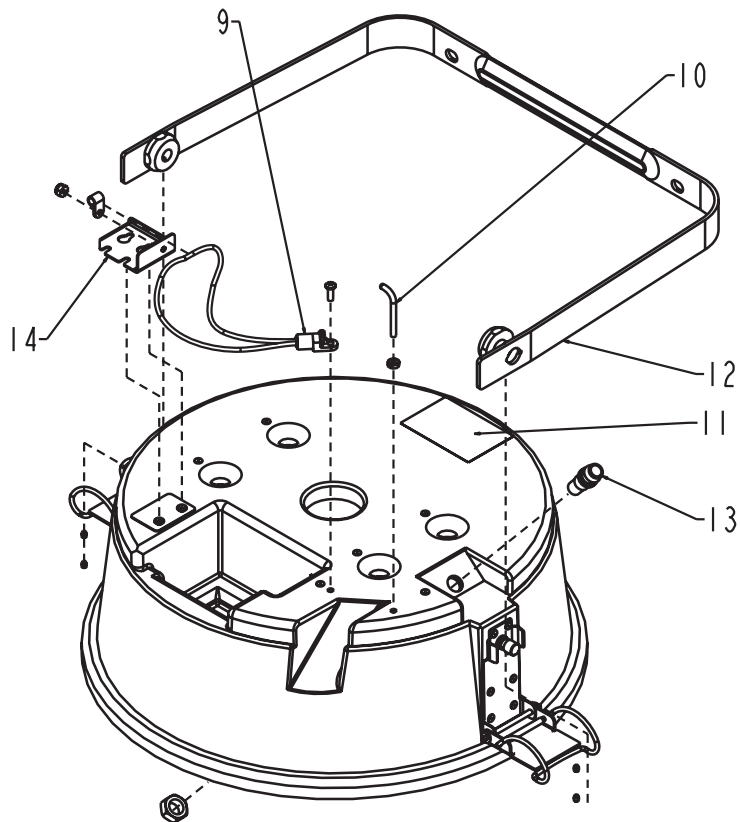

ITEM	INVENTORY NO.	DESCRIPTION
9	602954034	BATTERY HOLD-DOWN CORD
10	602953028	RETAINING HOOK
11	692953036	PUMP LABEL
12	602954023	GLS HANDLE ASSEMBLY
13	602953039	TUBE BULK HEAD FITTING
14	602954026	BATTERY HOLD-DOWN ASSEMBLY

602953043.DRW REV. J

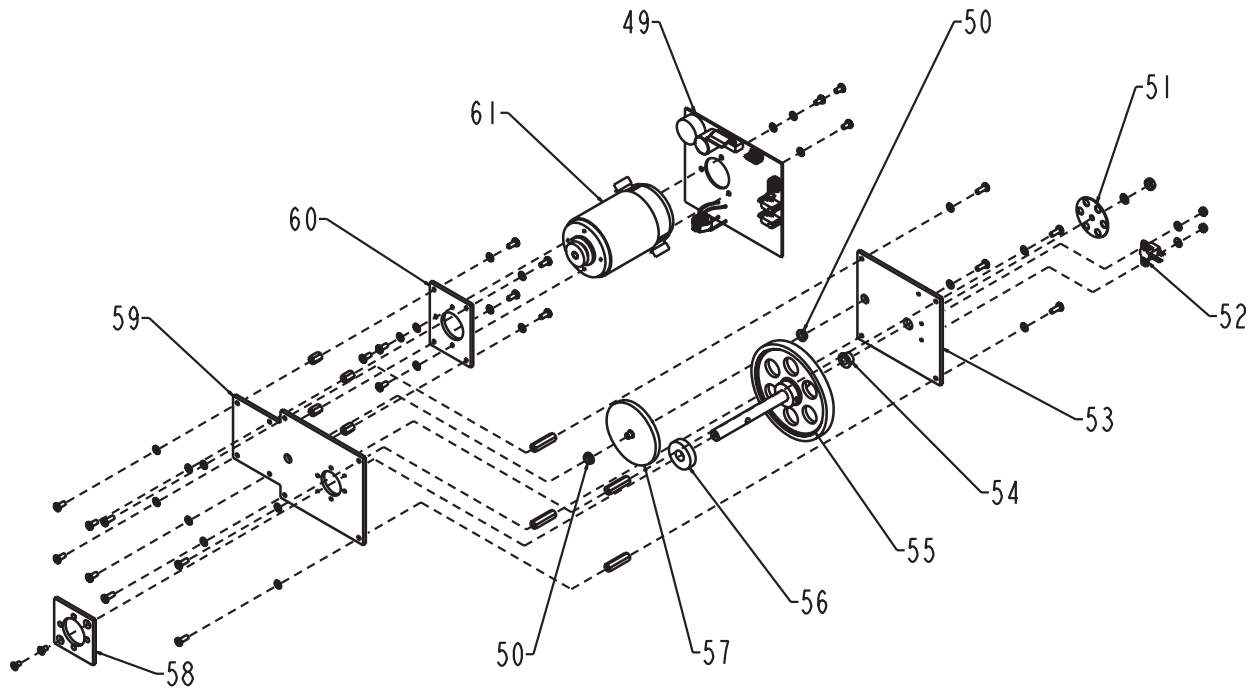

ITEM	INVENTORY NO.	DESCRIPTION
49	602954057	MOTOR DRIVER PCB ASSEMBLY
50	201311200	FLANGED BRONZE BEARING
51	609003112	PUMP SHAFT OPTICAL DISK
52	609004203	PUMP SENSOR CE WIRING ASSEMBLY
53	602954012	PUMP GEAR TRAIN TOP PLATE ASSEMBLY
54	201312300	FLANGED BRONZE BEARING .252 ID
55	602954011	PUMP SHAFT ASSEMBLY
56	602953012	PUMP SHAFT SPACER
57	602954010	COMBINATION GEAR ASSEMBLY
58	602703037	PUMP SHAFT SPACER PLATE
59	602953010	PUMP GEAR TRAIN BOTTOM PLATE
60	602953009	PUMP MOTOR PLATE
61	602954009	PUMP MOTOR ASSEMBLY

602953043.DRW REV. J

ITEM	INVENTORY NO.	DESCRIPTION
15	692953011	TRIM RING
16	602954005	CONTROL PANEL ASSEMBLY (ITEMS 17, 18, 47 & 48)
17	692954057	KEYBOARD PCB ASSEMBLY
18	602954056	CPU PCB ASSEMBLY
19	602903011	CONTROL BOX GASKET
20	602953017	INTERCONNECT STRAP
21	602964007	PUMP GEAR ASSEMBLY
22	692953016	CONNECTOR LABEL (2 PER SHEET)
23	602954015	POWER CONNECTOR WIRING HARNESS
24	603113024	MEDIUM CONNECTOR PROTECTOR CAP
25	603113032	MEDIUM CONNECTOR CAP GASKET
26	609005001	CONNECTOR CAP STRAP, MOD
27	602964018	WIRING HARNESS, CONTROLLER, GLACIER PORTABLE SAMPLER
28	601393082	AMP 2-PIN SEAL GASKET
29	601473057	AMP 6-PIN SEAL GASKET
30	602903121	BACK PLATE GASKET
31	602954013	CONNECTOR BACKING PLATE ASSEMBLY
32	202999903	LIP SEAL, 3/4" BORE, 3/8" SHAFT
33	603704019	INSIDE PUMP HOUSING ASSEMBLY (INCLUDES ITEMS 32, 34 & 41)
34	603703012	PUMP HOUSING BUSHING
35	602704019	PUMP ROTOR ASSEMBLY
36	603703278	PUMP HOUSING BUSHING
37	603704017	OUTSIDE PUMP HOUSING ASSEMBLY (INCLUDES ITEM 36)
38	602954030	GLS PUMP TUBE ASSEMBLY
39	603704021	DETECTOR LID ASSEMBLY
40	603704022	DETECTOR BASE ASSEMBLY
41	692953037	PUMP CAUTION LABEL
42	602954002	CONTROL BOX MOD ASSEMBLY
43	692953018	2-7/8" X 2-5/16" X 4" BOX
44	099000208	4 OZ DESICCANT BAG
47	209902138	Ø .375 ACETAL TENSION CLIP
48	490001300	HUMIDITY INDICATOR CARD
62	233010400	WASHER, FLAT, #4 SST
63	601113011	SPACER, .125ID X .188 OD X .065 LONG

602953043.DRW REV. J

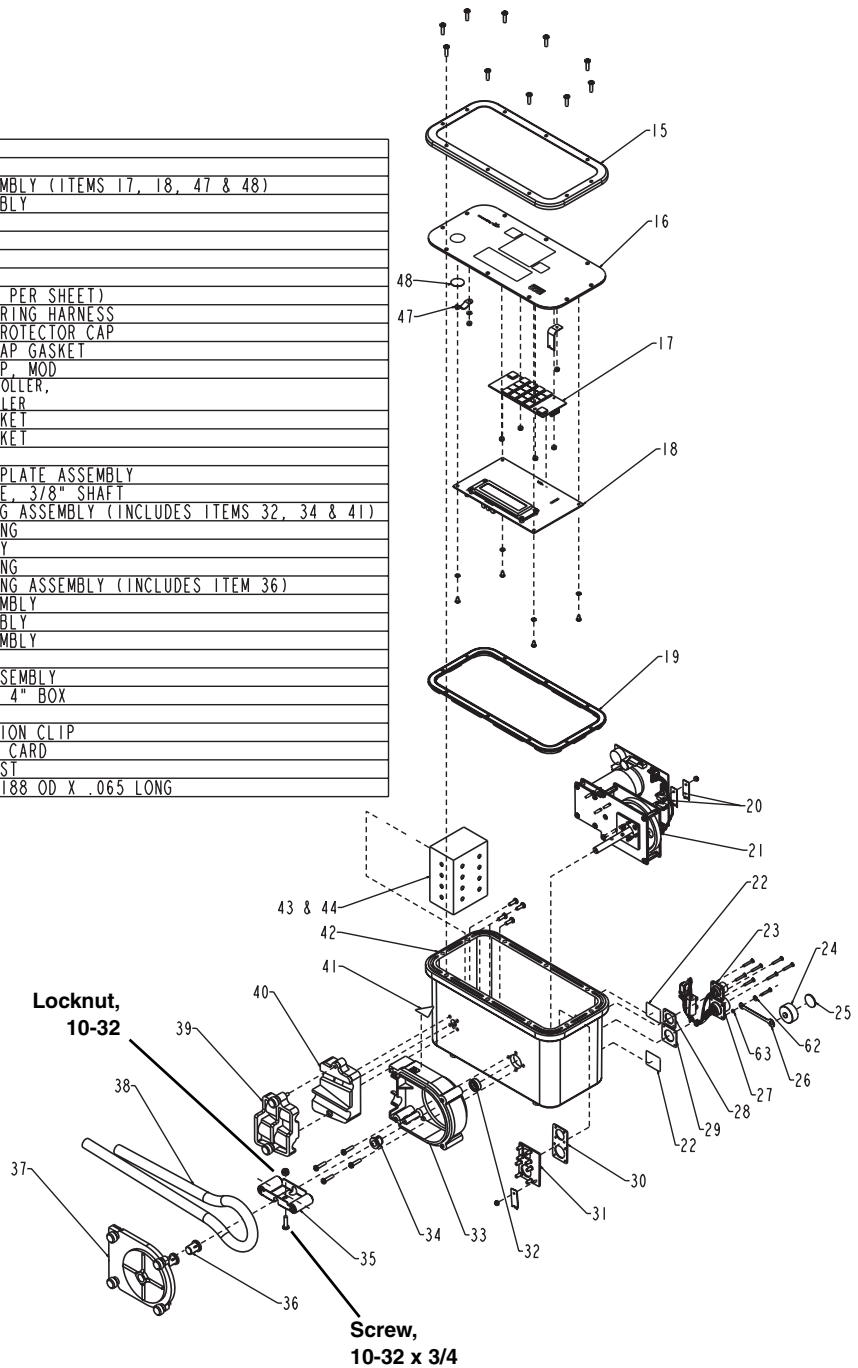

GLS Compact Sampler

Appendix B Material Safety Data Sheets

This appendix to the manual provides Material Safety Data Sheets for the desiccant used by the GLS Sampler.

Isco cannot guarantee the accuracy of the data. Specific questions regarding the use and handling of the products should be directed to the manufacturer listed on the MSDS.

101 Christine Drive
Belen, New Mexico 87002
Phone: (505) 864-6691
Fax: (505) 861-2355



ISO 9002

MATERIAL SAFETY DATA SHEET -- September 28, 1998
SORB-IT®
Packaged Desiccant

SECTION I -- PRODUCT IDENTIFICATION

Trade Name and Synonyms:	Silica Gel, Synthetic Amorphous Silica, Silicon, Dioxide
Chemical Family:	Synthetic Amorphous Silica
Formula:	SiO ₂ .x H ₂ O

SECTION II -- HAZARDOUS INGREDIENTS

Components in the Solid Mixture

COMPONENT	CAS No	%	ACGIH/TLV (PPM)	OSHA-(PEL)
Amorphous Silica	63231-67-4	>99	PEL - 20 (RESPIRABLE), TLV - 5	LIMIT - NONE, HAZARD - IRRITANT "

Synthetic amorphous silica is not to be confused with crystalline silica such as quartz, cristobalite or tridymite or with diatomaceous earth or other naturally occurring forms of amorphous silica that frequently contain crystalline forms.

This product is in granular form and packed in bags for use as a desiccant. Therefore, no exposure to the product is anticipated under normal use of this product. Avoid inhaling desiccant dust.

SECTION III -- PHYSICAL DATA

Appearance and Odor:	White granules; odorless.
Melting Point:	>1600 Deg C; >2900 Deg F
Solubility in Water:	Insoluble.
Bulk Density:	>40 lbs./cu. ft.
Percent Volatile by Weight @ 1750 Deg F:	<10%.

101 Christine Drive
Belen, New Mexico 87002
Phone: (505) 864-6691
Fax: (505) 861-2355



MATERIAL SAFETY DATA SHEET -- September 28, 1998
SORB-IT®
Packaged Desiccant

SECTION IV -- FIRE EXPLOSION DATA

Fire and Explosion Hazard - Negligible fire and explosion hazard when exposed to heat or flame by reaction with incompatible substances.

Flash Point - Nonflammable.

Firefighting Media - Dry chemical, water spray, or foam. For larger fires, use water spray fog or foam.

Firefighting - Nonflammable solids, liquids, or gases: Cool containers that are exposed to flames with water from the side until well after fire is out. For massive fire in enclosed area, use unmanned hose holder or monitor nozzles; if this is impossible, withdraw from area and let fire burn. Withdraw immediately in case of rising sound from venting safety device or any discoloration of the tank due to fire.

SECTION V -- HEALTH HAZARD DATA

Health hazards may arise from inhalation, ingestion, and/or contact with the skin and/or eyes. Ingestion may result in damage to throat and esophagus and/or gastrointestinal disorders. Inhalation may cause burning to the upper respiratory tract and/or temporary or permanent lung damage. Prolonged or repeated contact with the skin, in absence of proper hygiene, may cause dryness, irritation, and/or dermatitis. Contact with eye tissue may result in irritation, burns, or conjunctivitis.

First Aid (Inhalation) - Remove to fresh air immediately. If breathing has stopped, give artificial respiration. Keep affected person warm and at rest. Get medical attention immediately.

First Aid (Ingestion) - If large amounts have been ingested, give emetics to cause vomiting. Stomach siphon may be applied as well. Milk and fatty acids should be avoided. Get medical attention immediately.

First Aid (Eyes) - Wash eyes immediately and carefully for 30 minutes with running

101 Christine Drive
Belen, New Mexico 87002
Phone: (505) 864-6691
Fax: (505) 861-2355



ISO 9002

MATERIAL SAFETY DATA SHEET -- September 28, 1998
SORB-IT®
Packaged Desiccant

NOTE TO PHYSICIAN: This product is a desiccant and generates heat as it adsorbs water. The used product can contain material of hazardous nature. Identify that material and treat accordingly.

SECTION VI -- REACTIVITY DATA

Reactivity - Silica gel is stable under normal temperatures and pressures in sealed containers. Moisture can cause a rise in temperature which may result in a burn.

SECTION VII -- SPILL OR LEAK PROCEDURES

Notify safety personnel of spills or leaks. Clean-up personnel need protection against inhalation of dusts or fumes. Eye protection is required. Vacuuming and/or wet methods of cleanup are preferred. Place in appropriate containers for disposal, keeping airborne particulates at a minimum.

SECTION VIII -- SPECIAL PROTECTION INFORMATION

Respiratory Protection - Provide a NIOSH/MSHA jointly approved respirator in the absence of proper environmental control. Contact your safety equipment supplier for proper mask type.

Ventilation - Provide general and/or local exhaust ventilation to keep exposures below the TLV. Ventilation used must be designed to prevent spots of dust accumulation or recycling of dusts.

Protective Clothing - Wear protective clothing, including long sleeves and gloves, to prevent repeated or prolonged skin contact.

Eye Protection - Chemical splash goggles designed in compliance with OSHA regulations are recommended. Consult your safety equipment supplier.

101 Christine Drive
Belen, New Mexico 87002
Phone: (505) 864-6691
Fax: (505) 861-2355



ISO 9002

MATERIAL SAFETY DATA SHEET -- September 28, 1998
SORB-IT®
Packaged Desiccant

SECTION IX -- SPECIAL PRECAUTIONS

Avoid breathing dust and prolonged contact with skin. Silica gel dust causes eye irritation and breathing dust may be harmful.

* No Information Available

HMIS (Hazardous Materials Identification System) for this product is as follows:

Health Hazard	0
Flammability	0
Reactivity	0
Personal Protection	HMIS assigns choice of personal protective equipment to the customer, as the raw material supplier is unfamiliar with the condition of use.

The information contained herein is based upon data considered true and accurate. However, United Desiccants makes no warranties expressed or implied, as to the accuracy or adequacy of the information contained herein or the results to be obtained from the use thereof. This information is offered solely for the user's consideration, investigation and verification. Since the use and conditions of use of this information and the material described herein are not within the control of United Desiccants, United Desiccants assumes no responsibility for injury to the user or third persons. The material described herein is sold only pursuant to United Desiccants' Terms and Conditions of Sale, including those limiting warranties and remedies contained therein. It is the responsibility of the user to determine whether any use of the data and information is in accordance with applicable federal, state or local laws and regulations.

GLS Compact Sampler

Index

A

Accessories, 6-5
Applications, 1-2

B

Batteries, 2-4
Bottle full detection disable, 6-3
Bottle installation, 2-3
Bottle sizes, 6-4

C

Cleaning
 bottles, 5-2
 protocols for priority pollutants, 5-2
 tubing, 5-2
Compatible equipment, 1-2
Composite sampling interval, 3-7
Contacting Isco for assistance, 5-11
Continuous sampling mode, 3-6

D

Delay, 3-6, 4-1
Desiccant
 renewing, 5-8
Diagnostics, 5-9
Display, 3-2

E

Errors, 4-6
Event mark, 4-3
External devices, 2-8

F

FCC Warning, 1-3
Flash updates, 6-4

G

Grab samples, 4-7

H

Humidity indicator, 5-7

I

Inhibiting sampling, 4-1
Installation, 2-8

K

Keypad, 3-2

L

Liquid detector disable, 6-3

M

Material Safety Data Sheets, B-1
Maximum run time, 3-7
MSDS, B-1

O

Operating states, 3-2
Options
 liquid detector disable, 6-3
 program lock, 6-1
 program storage, 6-2

P

Password protection, 6-1
Pausing or stopping a program, 4-4
Post-sampling activities, 4-4
 Errors, 4-6
 Log, 4-5
 Preparing the full sample bottle, 4-5
 Recovering the sampler, 4-5
Power Packs, 2-4
Preparing the GLS
 attaching the strainer, 2-6
 connecting the suction line, 2-7
 discharge tube, 2-3
 inspect the pump tube, 2-1
 Install the bottle, 2-3
 positioning the GLS, 2-8
Program completion, 4-4
Program storage, 6-2
Program suspension, 4-1
Programming, 3-3
 bottle volume, 3-5
 number of samples, 3-6
 one-button, 3-3
 pacing, 3-4
 pacing interval, 3-4
 program start time, 3-6
 standard programming, 3-3
 Start time, 3-7
 stored program, 3-3
Pump tube

inspection, 2-1
warning, 2-2

R

Radio Interference Statement, 1-3
Replacement parts, A-1
Return instructions, 5-11
Run state displays, 4-2

S

Sample cooling, 2-4
Sample Cycle
 Fill, 4-3
 Post-purge, 4-4
 Pre-purge, 4-3
Sample pacing, 3-4
Sample volume calibration, 3-9
Service, 5-1
 cleaning, 5-1
 contacting Isco, 5-11
 desiccant, 5-6
 discharge tube, 5-5
 power sources, 5-6
 pump tube, 5-3
Single samples, 4-7
Site selection, 2-8
Software updates, 6-4
Start time, 3-7
Start times, 3-6
Starting a program, 4-1
Stopping a program, 4-4
Storing a program, 6-2
Strainer, 2-6
 attaching, 2-6
 maximum depths, 2-8
 positioning, 2-8
Suction line, 2-6
 connecting, 2-7
 cutting, 2-6
 PTFE, 2-7
 routing, 2-8
 Vinyl, 2-7

DECLARATION OF CONFORMITY

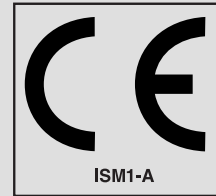

Application of Council Directive: 89/336/EEC – The EMC Directive
73/23/EEC – The Low Voltage Directive

Manufacturer's Name: Teledyne Isco, Inc.

Manufacturer's Address: 4700 Superior, Lincoln, Nebraska 68504 USA
Mailing Address: P.O. Box 82531, Lincoln, NE 68501

Equipment Type/Environment: Laboratory Equipment for Light Industrial/Commercial Environments

Trade Name/Model No: GLS Sampler

Year of Issue: 1998

Standards to which Conformity is Declared: EN 61326-1998 EMC Requirements for Electrical Equipment for
Measurement, Control, and Laboratory Use
EN 61010-1 Safety Requirements for Electrical Equipment for Measurement,
Control, and Laboratory Use

Standard	Description	Severity Applied	Performance Criteria
EN61000-4-2	Electrostatic Discharge	Level 2 - 4kV contact discharge Level 3 - 8kV air discharge	A A
EN61000-4-3	Radiated RF Immunity	80 MHz to 1000MHz 80% AM at 1kHz Level 1 - 10V/m	A
EN61000-4-4	Electrical Fast Transient	Level 2 - 2kV on ac lines	A
EN61000-4-5	Surge on AC Lines	2kV common mode, 1kV differential mode	A
EN61000-4-6	Conducted RF on AC lines	150 kHz to 80 MHz, 3V rms, 80% modulated	A
EN61000-4-11	Voltage Dips/Short Interruptions	0.5 cycle, each polarity/100%	A
CISPR11/ EN 55011	RF Emissions	Group 1, Class A Industrial, Scientific, and Medical Equipment	
EN61000-3-2, 3-3	Harmonic, Flicker		

We, the undersigned, hereby declare that the design of the equipment specified above conforms to the above Directive(s) and Standards as of October 12, 1998.

William Foster
USA Representative



William Foster
Director of Engineering
Teledyne Isco, Inc.
4700 Superior Street
Lincoln, Nebraska 68504

Phone: (402) 464-0231
Fax: (402) 464-4543

60-2953-041
Rev C

Teledyne Isco One Year Limited Warranty*

Factory Service for Teledyne Isco Flow Meters, Waste Water Samplers, and Syringe Pumps

This warranty exclusively covers Teledyne Isco instruments, providing a one-year limited warranty covering parts and labor.

Any instrument that fails during the warranty period due to faulty parts or workmanship will be repaired at the factory at no charge to the customer. Teledyne Isco's exclusive liability is limited to repair or replacement of defective instruments. Teledyne Isco is not liable for consequential damages.

Teledyne Isco will pay surface transportation charges both ways within the 48 contiguous United States if the instrument proves to be defective within 30 days of shipment. Throughout the remainder of the warranty period, the customer will pay to return the instrument to Teledyne Isco, and Teledyne Isco will pay surface transportation to return the repaired instrument to the customer. Teledyne Isco will not pay air freight or customer's packing and crating charges. This warranty does not cover loss, damage, or defects resulting from transportation between the customer's facility and the repair facility.

*** This warranty applies to the USA and countries where Teledyne Isco Inc. does not have an authorized dealer. Customers in countries outside the USA, where Teledyne Isco has an authorized dealer, should contact their Teledyne Isco dealer for warranty service.**

The warranty for any instrument is the one in effect on date of shipment. The warranty period begins on the shipping date, unless Teledyne Isco agrees in writing to a different date.

Excluded from this warranty are normal wear; expendable items such as charts, ribbon, lamps, tubing, and glassware; fittings and wetted parts of valves; and damage due to corrosion, misuse, accident, or lack of proper maintenance. This warranty does not cover products not sold under the Teledyne Isco trademark or for which any other warranty is specifically stated.

No item may be returned for warranty service without a return authorization number issued by Teledyne Isco.

This warranty is expressly in lieu of all other warranties and obligations and Teledyne Isco specifically disclaims any warranty of merchantability or fitness for a particular purpose.

The warrantor is Teledyne Isco, Inc. 4700 Superior, Lincoln, NE 68504, U.S.A.

Before returning any instrument for repair, please call, fax, or e-mail the Teledyne Isco Service Department for instructions. Many problems can often be diagnosed and corrected over the phone, or by e-mail, without returning the instrument to the factory.

Instruments needing factory repair should be packed carefully, and shipped to the attention of the service department. Small, non-fragile items can be sent by insured parcel post. **PLEASE BE SURE TO ENCLOSE A NOTE EXPLAINING THE PROBLEM.**

Shipping Address: Teledyne Isco, Inc. - Attention Repair Service
4700 Superior Street
Lincoln, NE 68504 USA

Mailing Address: Teledyne Isco, Inc.
PO Box 82531
Lincoln, NE 68501 USA

Phone: Repair service: (800) 775-2965 (lab instruments)
(866) 298-6174 (samplers & flow meters)
Sales & General Information: (800) 228-4373 (USA & Canada)

Fax: (402) 465-3001

Email: IscoService@teledyne.com



March 8, 2011 P/N 60-1002-040 Rev E

