

Easy to Use



Functionality

1200/2200 SLM User Manual



Thank you for choosing Quest Technologies, a 3M company to meet your sound measuring needs. The Quest 1200 Sound Level Meter is a light weight easy-to-use Type 1 instrument and the 2200 is our Type 2 model. It is our goal to make your decision to buy Quest products the right one, and to provide support for any questions or concerns that might arise.

The purpose of this manual is to provide the user with the necessary information to operate the 1200/2200 Sound Level Meter as well as the remoteable versions of the 1200R/2200R. The entire manual should be read to fully understand the many features this instrument offers.

This manual is not all inclusive and cannot cover all unique situations. In addition, no warranties are contained in this manual except as described under the warranty policy section.

Copyright 2010

Revision E

P/N 056-653

–

Note: Due to the new ATEX Directive in Europe, all references in this document to "Ex" or "EEEx" for intrinsic safety approvals should be disregarded effective 7/1/03 within the member countries of the European Union (EU). At this time, this product is not approved in accordance with the new ATEX Directive and is not sold for use in hazardous atmospheres or explosive zones by customers within the EU. Outside of the EU, all references to intrinsic safety continue without change.

Table of Contents

1. INTRODUCTION	1
2. GENERAL OVERVIEW	2
2.1 The Display	2
2.2 Meter Controls.....	3
2.2.1 OFF/PAUSE/RUN Switch.....	3
2.2.2 SPL/LEQ/RT/MAX/MIN/% OL Switch/ - UR.....	3
2.2.3 FAST/SLOW/PEAK/IMP RESPONSE Switch	4
2.2.4 A/C/Z Switch.....	4
2.2.5 RANGE (dB) Switch.....	4
2.2.6 RESET Button.....	5
2.2.7 CAL Button	5
2.3 Output Jack	5
2.4.1 DC Output Function	6
2.4.2 AC Output Function	6
3. METER INTEGRITY	7
3.1 Power On/Battery Check.....	7
3.1.1 Battery Replacement	7
3.2 Setup	7
3.2.1 Changing the Exchange Rate	7
3.2.2 Changing the Calibration Level	7
3.3 Calibration	8
3.3.1 Calibration Check	8
3.4 Switch Settings to Select Measurements.....	9
4. OPERATION	10
4.1 Meter/Microphone Placement	10
4.2 Background Noise	10
4.3 Windscreen Effects	11
4.4 Data Recording/ DATALOGGING	12
5. TECHNICAL INFORMATION.....	13
5.1 Principles of Operation	13
5.2 Microphone	13
5.3 Weighting Characteristics.....	15
5.4 Tone Burst Response	15
6. SPECIFICATIONS	18
7. ACCESSORIES	21
QUEST SERVICE POLICY.....	22
QUEST WARRANTY POLICY	23

Introduction

1. INTRODUCTION

The Quest models 1200 and 2200 and their remote versions (1200R/2200R) are Impulse and Integrating Sound Level Meters for measuring frequency weighted and time averaged SPL, weighted or unweighted Peaks or frequency weighted Leq. Applications include laboratory, industrial, community and military, measurement or analysis.

The models 1200 and 2200 are easy-to-use hand held meters with an LCD display that provides a numerical readout. They are housed in an R.F. shielded injection molded case. The meter is operated with simple slide switches. An output jack on the bottom of the meter is provided for connecting to peripheral devices such as chart recorders, oscilloscopes, audio recorders, etc.

The model 1200 provides Type 1 accuracy for precision measurements while the model 2200 provides Type 2 accuracy for general field survey work. **As both meters are operationally identical, this manual will refer only to the model 1200 except where appropriate.**

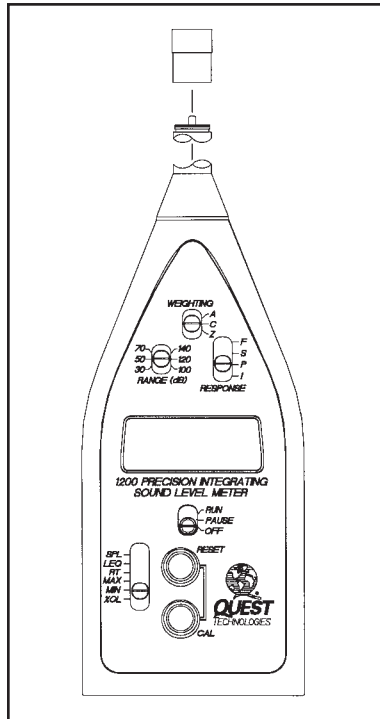

Figure 1a. Model 1200/2200

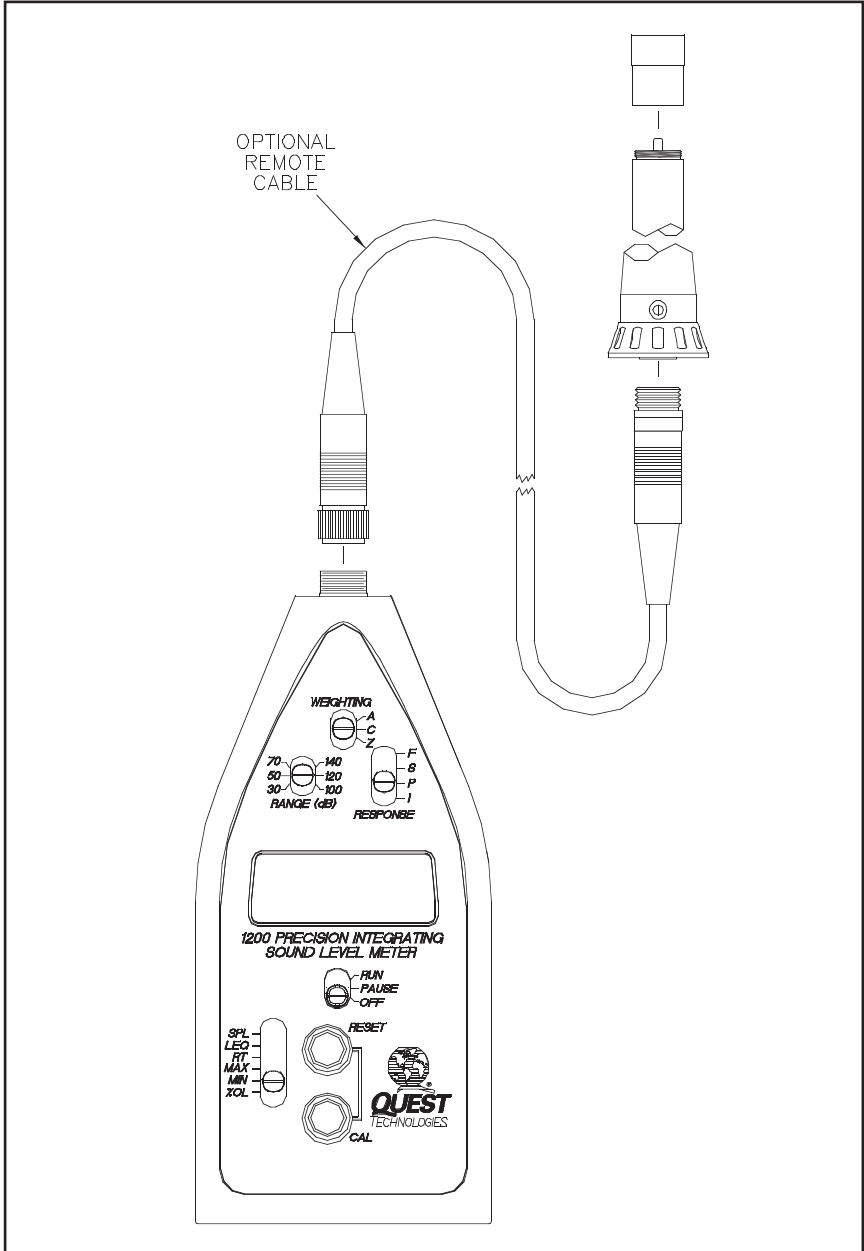

Figure 1b. Model 1200R/2200R Remote

2. GENERAL OVERVIEW

2.1 The Display:

The LCD display provides a numeric readout in 0.1dB increments along with a LOBAT (low battery) indicator. The LOBAT indicator will turn on when the voltage of the battery is too low to allow an accurate reading.

A plus sign '+' will appear on the left side of the display if signal peaks cause an overload condition in the electronics. If the signal falls below the measuring range, 'UR' (under range) will be displayed.

2.2 Meter Controls:

2.2.1 OFF/PAUSE/RUN Switch:

- OFF - In this position the power is removed from the instrument.
- PAUSE - In SPL mode the meter continuously displays sound pressure level according to the RESPONSE and WEIGHTING settings. In other modes the meter will display the appropriate value for the previous RUN or '---' if no run time has been accumulated. The meter automatically updates the current reading at a rate of once per second.
- RUN - Causes the meter to begin calculating the frequency weighted equivalent continuous SPL. All SPL measurements are integrated into a single number representing the equivalent SPL for the entire measurement period. This measurement will continue until the meter is placed in the PAUSE mode or reset. Maximum RUN time is 100 hours or as long as the battery lasts.

2.2.2 SPL/LEQ/RT/MAX/MIN/%OL Response Switch:

This six position switch determines the display mode of the meter.

- SPL - In the SPL mode the numeric display provides a reading of the maximum sound pressure level measured during the previous second.
- LEQ - In the LEQ mode, the display indicates the integrated, or average level for the RUN period. If no RUN time has been accumulated the display shows dashes.

- RT - In the RT mode the display shows the elapsed time of the current or last RUN. The RT mode consists of two or three displays. The first is RUN TIME seconds ':XX'. The second is RUN TIME hours/minutes 'XX:XX'. Pressing the CAL button while in the RT mode toggles the meter between these two displays. If the RUN TIME exceeds 20 hours, there will be a third display that will show hours up to 99 'h:XX'. If no RUN time has been accumulated the display shows dashes.
- MAX - In the MAX mode the display holds the highest reading encountered during the RUN period. If no RUN time has been accumulated the display shows dashes.
- MIN - In the MIN mode the display holds the lowest reading encountered during the RUN period. If no RUN time has been accumulated the display shows dashes.
- %OL - In the %OL mode the display shows the time that the circuitry has been overloaded as a percent of RUN TIME. If no RUN time has been accumulated the display shows dashes.
- UR - If an Under Range indicator designated as a "-"(minus) symbol appears on the display, then this indicates the Sound Pressure level is below the measuring range set on the Sound Level Meter.

2.2.3 FAST/SLOW/PEAK/IMP Response Switch:

The Response Switch controls the rate at which the meter responds to changing input signals. Most sound measurements are done with the response set to SLOW (S). The FAST (F) response is generally used when measuring short duration noises such as moving vehicles. PEAK (P) is useful when measuring the absolute peak of the sound pressure wave. IMPULSE (I) is used for impulsive or transient sounds.

The Response switch positions are as follows:

- FAST (F) - 125 millisecond time constant. (See Figure 10)
Decay Rate = 34.7 dB per second.
- SLOW (S) - 1 second time constant. (See Figure 11)
Decay Rate = 4.35 dB per second.
- PEAK (P) - 50 microsecond time constant.
- IMPULSE (I) - 35 millisecond rise time constant, 1.5 second decay time constant. (See Figure 12)

2.2.4 A/C/Z Switch:

The A/C/Z switch controls the frequency response (weighting) of all measurements. (See Figure 9)

2.2.5 RANGE (dB) Switch:

The displayed range of the model 1200 is 70 dB and is switchable between (30-100 dB),(50-120 dB), and (70-140 dB). After switching ranges allow several seconds for the meter electronics to stabilize. If a range change is necessary during a LEQ study, it is good practice to first set the meter to LEQ PAUSE, change range and then set the meter to RUN. This will avoid integrating any handling or switching noise into the LEQ measurement.

2.2.6 RESET Button:

This button is used primarily to clear data from the memory of the instrument. When pressed, the display will begin to count down from '02'. If the button is pressed and held, the display will count down '02,01, ---'. When the dashes are displayed the instrument memory is clear.

This button is also used as an up-arrow during setup. (see Operating Procedure)

2.2.7 CAL Button:

This button has three functions; It initiates a calibration, toggles between Run Time displays, and acts as a down arrow during setup. (see Operating Procedure)

2.3 Output Jack:

The model 1200 provides an output jack on the bottom of the meter for measuring the weighted AC signal before the rms/log detector and the DC output of that detector. Both signals are real time, i.e. LEQ is not represented at the DC output. This jack may be connected to any load without affecting the operation of the meter. Connection to low impedance loads will require correction for the 1 Kohm impedance of these outputs and will also decrease battery life.

The output jack takes a 3.5mm stereo plug. (See Figure 2, Output Jack Connections.)

2.3.1 DC Output Function:

The SPL or PEAK level over the range selected is linearly represented by a DC output. The output changes 16.7mV/dB or 1V/60dB. This output is provided for connecting a 0 to 1 volt span data recorder. (See section 4.4 Data Recording)

2.3.2 AC Output Function:

This jack provides the amplified, frequency weighted AC signal at the input of the RMS detector.

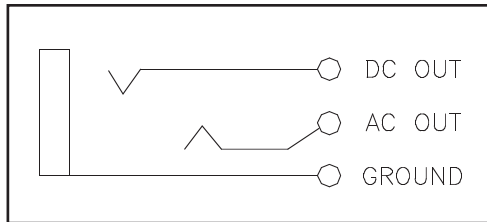

Figure 2. Output Jack Connections

3. METER INTEGRITY

3.1 Power On and Battery Check:

Set the OFF/PAUSE/RUN switch to either the PAUSE or RUN position as desired. At any time, other than initial turn-on, if the LOBAT indicator is displayed, the user must replace the battery. A 9 Volt Alkaline battery is recommended for best performance.

3.1.1 Battery Replacement:

Slide the battery door to the left to open the battery compartment. Refer to the sticker inside the compartment for proper battery orientation.

3.1.2 Rechargeable Batteries:

Nicad type rechargeable (9V batteries (such as Radio Shack® 23-299 7.2 V, 120 mAh) and an appropriate charger may be used with the 1200. The fact that nicad 9 V replacement cells typically operate at 7.2 V will be observed as shorter battery life (approximately 8 hours with Radio Shack® 23-299). At the appearance of the LOBAT indicator the nicad battery must be recharged.

NiMH (Nickel-Metal-Hydride) batteries are NOT recommended. This is due to the excessive discharge of the typical NiMH cell prior to the voltage dropping low enough to activate the LOBAT indicator.

3.2 Setup:

NOTE: There may be times when it is necessary to change the Exchange Rate or Calibration Level that is stored in the meter. Both of these items are accessible during the power-up sequence.

The power-up sequence is as follows:

1. All display segments turned on for 2 seconds.
2. The meter firmware revision 'rX.X' for 2 seconds.
3. The current Exchange Rate or Doubling Rate 'Er3' or 'Er5' for 3 seconds.
4. The current Calibration Level for 3 seconds.

3.2.1 Changing the Exchange Rate:

Turn on the meter.

When 'Er3' or 'Er5' appears in the display, press both the CAL and RESET button simultaneously until dashes are displayed.

At this point, pressing either the CAL or RESET button will toggle the Exchange Rate between 'Er3' and 'Er5'.

When the desired Exchange Rate is displayed, store the selection by pressing both the CAL and RESET buttons simultaneously. This completes the selection.

3.2.2 Changing the Calibration Level:

NOTE: The calibration level is the decibel level that is produced by your calibrator.

Turn on the meter.

When the current calibration level is displayed, press and hold both the RESET and CAL buttons until dashes appear. The meter is now in the calibration level set mode.

To edit the level, use the RESET key to increase the value and the CAL key to decrease to value. Edit the value to match your calibrator's output.

When the desired calibration level is displayed, press and hold both the RESET and CAL buttons until dashes appear on the display. The new calibration level is now stored in the instruments memory and will not have to be changed again unless an alternate calibrator is used.

3.3 Calibration:

The model 1200 may be calibrated in any range based on your calibrator's output. There is no warm up period required, but for maximum accuracy calibration should be performed at the temperature of the environment to be measured. To calibrate, perform the following procedure using a Quest Calibrator.

It is recommended that calibration be performed before each use.

1. Check that the LOBAT indicator is not on.
2. Check to see that the calibrator SPL output matches the calibration level stored in the meter. If it does not, use procedure outlined in section 3.2.

NOTE: Failure to match calibrator output level to calibration level stored in the 1200 will result in erroneous SPL readings.

3. Turn to calibrator ON. If optional, set the frequency to 1 KHz.
4. Place the black adapter ring fully onto the microphone.
5. Set the model 1200 to SPL, PAUSE, SLOW or FAST, and A or C weighting. Set the measuring range so that the calibration level falls within it.
6. If the 1200 has data in the memory, it must be cleared before calibration is possible. To do this, press and hold the RESET button. For more details see (RESET Button, section 2.2.6).
7. Press and hold the CAL button until 'CAL' appears in the display. Release the button. Three dashes will appear and then disappear one at a time as the meter calibrates. A final message of 'PAS' or 'BAD' will appear in the display. If 'BAD', review steps one through five.

3.3.1 Calibration Check:

It is a good idea to check calibration after use. To do so, perform the previous steps 1 through 5. Observe the meter display, it should read the calibrator level +/-0.5 dB. If out of tolerance, run calibration procedure in section 3.3.

3.4 Switch Settings to Select Measurement:

<u>To Measure:</u>	<u>Set Switches to:</u>	<u>Display:</u>
SPL	SPL, A,C or Z, RUN or PAUSE, RESPONSE of interest	1 second update
LEQ	LEQ, A,C or Z, RUN, RESPONSE of FAST, SLOW OR IMPULSE	Holds LEQ until RESET or Meter SETTING is changed
MAX HOLD	MAX, A,C or Z, RUN RESPONSE of interest	Holds MAX until RESET or Meter SETTING is changed

MIN HOLD	MIN, A,C or Z, RUN, RESPONSE of FAST, SLOW OR IMPULSE	Holds MIN until RESET or Meter SETTING is changed
----------	--	---

During an LEQ RUN, weighting, response, and range switch settings can not be changed. If these switches are changed, the LEQ measurement will stop, reset, and start again.

4. OPERATION

Before taking measurements, there is a series of quick checks that should be performed. After switching the unit ON check for a LOBAT indication on the display, and replace the battery if needed (see Section 3.1).

Although the model 1200 will maintain accurate calibration over a long period of time, the calibration should be checked before each use. The calibration should also be checked and verified after each use.

Set the RESPONSE, WEIGHTING, and RANGE (dB) switches as needed. Hold, set, or tripod mount the meter in the desired location. If a MAX, MIN, or LEQ measurement is needed, be sure to reset the meter before taking the measurements. It is good practice to document all measurement conditions and meter settings for possible future reference.

4.1 Meter/Microphone Placement:

Whenever possible, the meter should be tripod-mounted in a relatively open area to minimize reflections from the body or other large reflective structures. Avoid placement against a wall or in a corner. A threaded bushing on the back will accept a standard 1/4-20 tripod fitting.

The microphone cartridge used on the models 1200 and 2200 is a free-field microphone. Point it directly at the noise source (0 degrees).

Random incidence measurements may be taken with the 1200 if the plastic random incidence corrector supplied with the BK4936 microphone is used. The random incidence corrector is a black plastic lipped sleeve packed in the BK4936 packing container. To attach the corrector, position the end of the sleeve without the lip over the grid of the microphone and gently press down until a snap fit is achieved.

4.2 Background Noise:

Background noise can cause considerable error in measurement when its level is close to that of the particular sound source of interest. When it is not possible to eliminate or reduce the background noise, use the curve shown in Figure 3 to correct for the effect of the background noise on the measurement.

For example, if the background noise is 45dB and the sound of interest measures 51dB, the difference between measurement and background noise is 6dB. From Figure 3, for a 6dB difference, 1.3dB should be subtracted from the measurement. The correct measurement is therefore $51\text{dB} - 1.3\text{dB} = 49.7\text{dB}$.

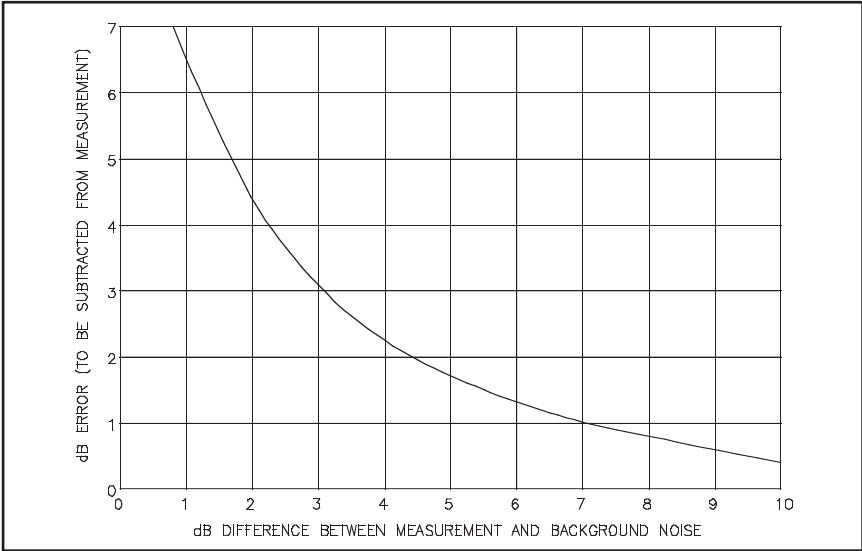

Figure 3. Effects of Background Noise

4.3 Wind Screen Effects:

To prevent measurement errors caused by wind blowing across the microphone, the use of a windscreen is recommended. The wind screen will reduce wind effects and will also help protect the microphone under dusty, oily, or humid conditions. Acoustic attenuation effects of the windscreen (WS-7) are shown in Figure 4.

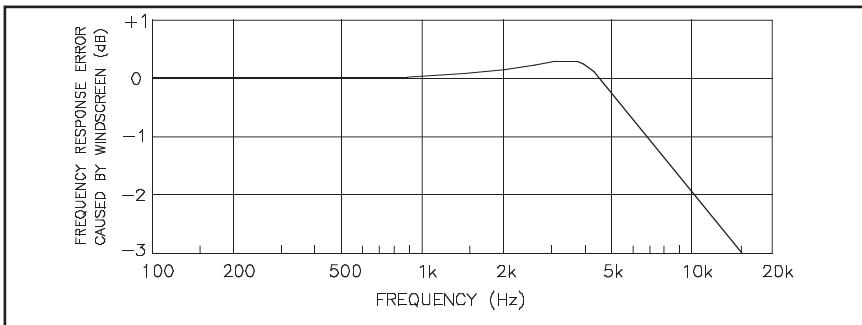

Figure 4. Effects of Windscreen

4.4 Data Recording:

The model 1200 has a DC output that is linearly related to the deciBel reading on the LCD display by 16.7mV/dB (1V/60dB).

This output, capable of driving up to 100 feet of shielded or twisted pair cable, is intended for use with a chart recorder or data acquisition device that has a high input impedance. The output impedance is 1000 ohms. Recorder input impedance may cause loading of this output, which should be taken into account. Multiplication factors for the above numbers are given below for various recorder input impedances.

INPUT IMPEDANCE OF RECORDER:	MULTIPLY DC VOLTAGE BY:
10 KOHM	1.100
20 KOHM	1.050
50 KOHM	1.020
100 KOHM	1.010

5. TECHNICAL INFORMATION

5.1 Principles of Operation:

The Quest model 1200 uses low noise, low power analog and digital integrated circuitry to ensure long battery life, maximum stability, and superior reliability over a wide range of environmental conditions. Figure 5 is a block diagram of the model 1200/2200's internal circuit operations.

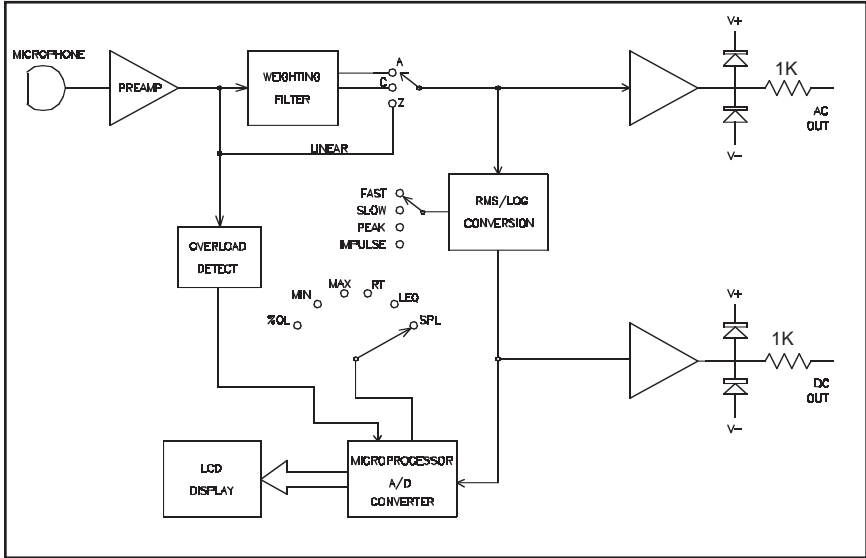

Figure 5. 1200/2200 Block Diagram

5.2 Microphone:

The model 1200 is designed to accept a prepolarized (electret) Type 1 microphone Quest P/N #059-523 (BK #4936). The impedance of this microphone is approximately 12pF. The microphone screws directly onto either the remoteable preamp or the fixed microphone extension of the meter case. A typical response curve for the Type 2 microphone is shown in Figure 6.

The model 2200 is designed to accept a prepolarized (electret) Type 2 microphone Quest P/N #056-316 (QE7052). The impedance of this microphone is approximately 15pF. The microphone screws directly onto either the remoteable preamp or the fixed microphone extension of the meter case. A typical response curve for the Type 2 microphone is shown in Figure 7.

Technical Information

CAUTION: When installing or removing the microphone, do not unscrew the protective grid. Do not touch the metal foil microphone diaphragm under this grid as permanent damage may result.

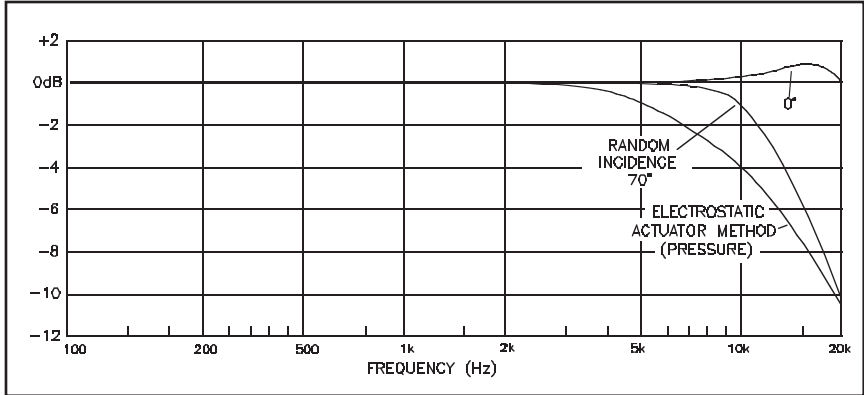

Figure 6. Typical microphone response Type 1

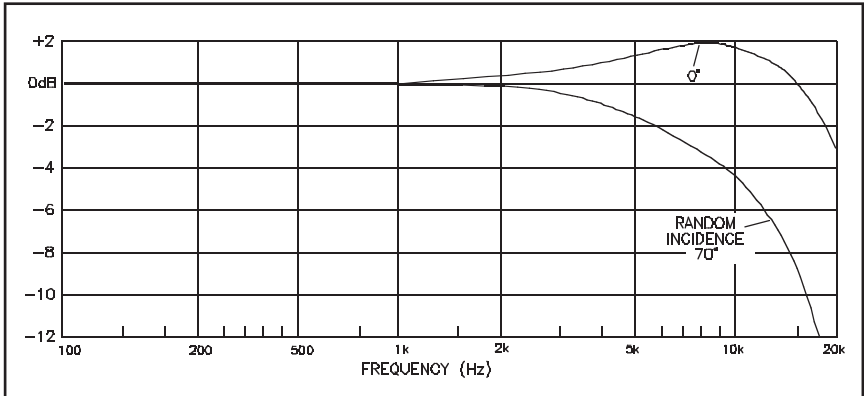

Figure 7. Typical microphone response Type 2

5.3 Microphone Preamplifier Extension Cables

On 1200R (Remote) units the preamplifier is removable by unscrewing the black plastic collar below the preamplifier housing. The 1200 will drive up to a 10 foot cable with minimal loss. Quest offers the following lengths of remote cable for use with the 1200:

- #59-899 ICM-2 Microphone Cable (2 foot length)
- #59-733 ICM-10 Microphone Cable (10 foot length)
- #59-734 ICM-50 Microphone Cable (50 foot length)

The calibration level at 1 kHz is affected by less than 0.1 dB with the insertion of either of these cables. Therefore, there is no need to recalibrate when the cable is attached.

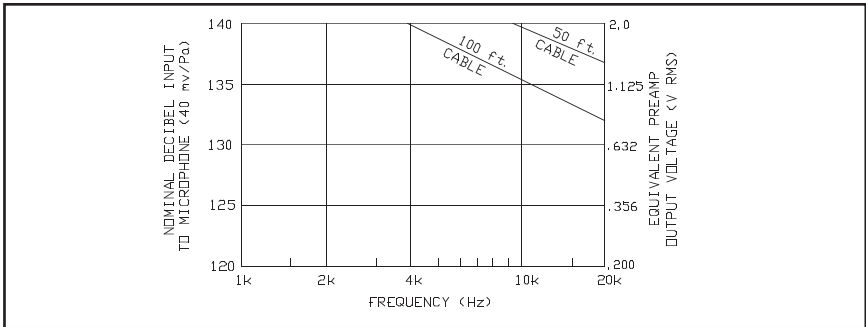

Figure 8. Frequency/Amplitude Limitations with Extension Cables

5.4 Input Buffer Circuitry

The high impedance input circuitry of the 1200 will accept up to a 2.0 volt RMS signal. With the microphone and preamp removed, other transducer devices may be connected to give a dB readout on the meter. To remove the preamplifier unscrew the black plastic collar below the preamp housing. Only use pins 1 and 3 for the AC signal input. NEVER connect to pins 2 and 4. To input an electrical signal requires a special connector, Quest part number 14-739. Figure 9 shows the function of each of the pins within the meter input connector.

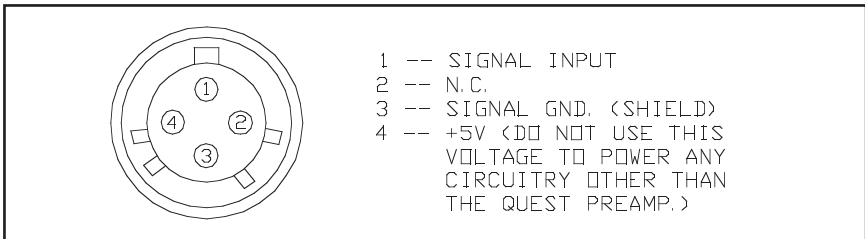

Figure 9. Meter Input Connector

5.5 Weighting Characteristics

The weighting characteristics (frequency response) for A, C, and Z are shown in Figure 10. The "A" weighting response emulates the response of the human ear and is used for most industrial and community noise measurements. Generally, "C" weighting is used for measuring noise reduction in hearing protectors and for other scientific purposes. "Z" is a linear response from 5 Hz to 20 kHz.

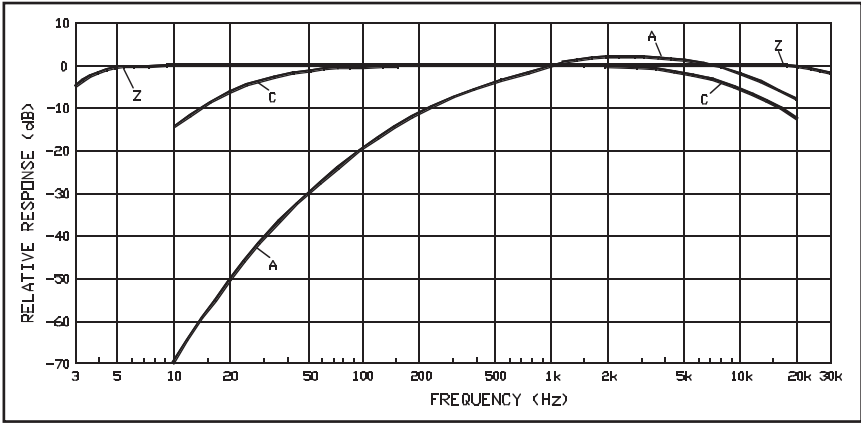

Figure 10. A, C & Z Weighting

5.6 Tone Burst Response

Figures 11, 12 and 13 show how the meter responds to a sinewave input of varied pulse duration for each response setting.

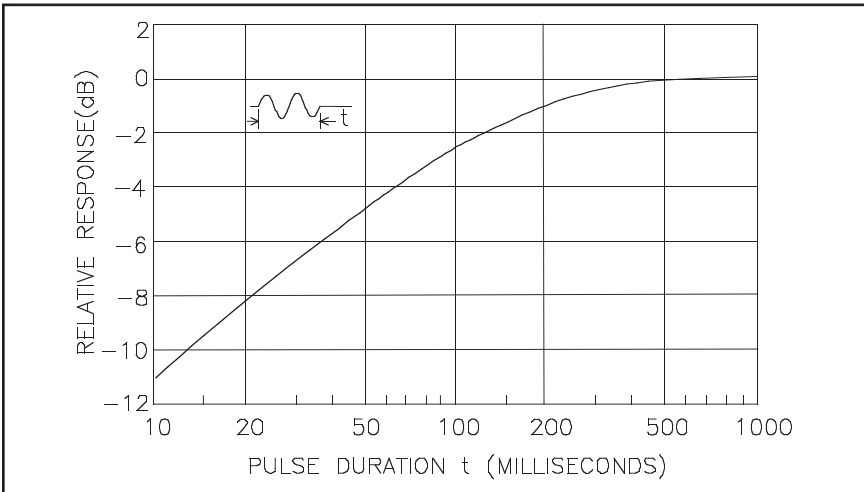

Figure 11. Fast Response

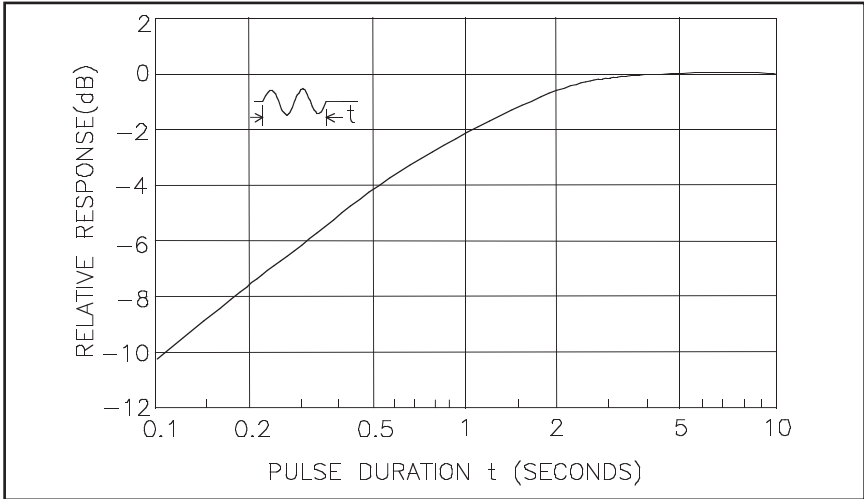

Figure 12. Slow Response

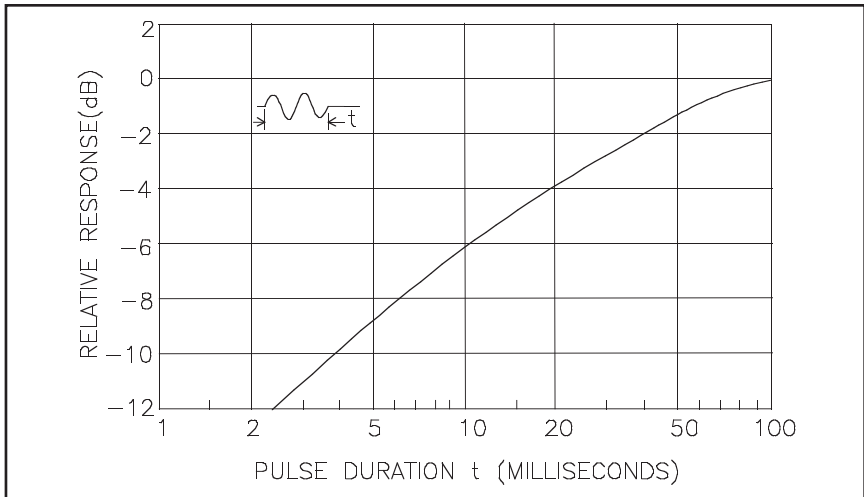

Figure 13. Impulse Response

Nominal decay times for each time response setting are as follows:

FAST - 34.7 dB per second

SLOW - 4.35 dB per second

IMPULSE - 2.9 dB per second

PEAK measurements have a rise time constant of 50 μ S. The displayed value is the highest peak occurring prior to a reset. Resets occur every second in PAUSE. When the meter is in RUN a manual reset is required.

Specifications

6. SPECIFICATIONS

Standards:	Model 1200 : Type 1 ; Model 2200 : Type 2 ANSI S1.43-1997, ANSI s1.4-1983(R1997), IEC 651-1979, IEC 804-1985
Display:	3 1/2 Digit Liquid Crystal Display. Level display indicates to 0.1 dB resolution. An enunciator is included for Battery Check.
Modes of Operation:	Measures sound pressure level (SPL) maximum level (MAX), minimum level(MIN), and equivalent continuous sound pressure level (LEQ) .
Linear Operating Range:	34 to 140 dBA SPL, 43 to 143 dBA PEAK 37 to 140 dBC SPL, 43 to 143 dBC PEAK 42 to 140 dBZ SPL, 43 to 143 dBZ PEAK
Pulse Range:	63 dB
Electrical Noise Floor:	26 dBA typ., 30dBC typ., 35 dBZ typ.
Frequency Weighting Networks:	A, C, and Z
Meter Repsonse:	Fast, Slow, Impulse or Peak (50uS rise time constant).
Microphone:	Removable .52 inch (13.5mm) prepolarized condenser (electret) microphone. Model 1200 - Type 1 accuracy, P/N: 059-523 BK 4936 Model 2200 - Type 2 accuracy, P/N: 056-317 QE 7052
AC Output:	Approximately 0-1 Volt AC RMS 1 Kohm output impedance, 3.5 mm stereo jack
DC Output:	Approximately 0-1 Volt DC Each 0.167V change equals 10dB (1V/60dB) 1 Kohm output impedance, 3.5 mm stereo jackLinear

Detector:	True RMS
Integration Time:	Signal Dependent - approximately 2.5 hours at a constant 140dB SPL. Time will double with each 3dB decrease in average SPL, until limited by battery life.
Overload Indication:	A '+' sign in the display indicates overload during Leq measurement.
Accuracy:	Within 0.5 dB at 23°C; Within 1.0 dB over the temperature range of -10 C to +50 C
Level Range Accuracy:	+/- 0.5dB from 31.5 - 8000 Hz (1200) +/- 1.0dB from 20 - 12500 Hz (1200) +/- 0.7dB from 31.5 - 8000 Hz (2200)
Temperature Range:	Operation: -10 C to +50 C
Storage (less batteries):	-20 C to +60 C
Operating Humidity:	0 to 95% relative humidity, non-condensing.
Effect of Electromagnetic Fields:	Negligible.
Effect of Electrostatic Fields:	Negligible.
Battery:	One 9-volt alkaline battery ANSI/NEDA Type 1604A or IEC: Type 6LR61 Typical: Energizer 522 (Quest 058-176)

Specifications

Battery Life:	9 Volt Alkaline, approximately 25 hours 9 Volt NICAD, approximately 8 hours
Size:	2200: 2.8 x 7.6 x 1.3 inches (including mic) 1200: 2.8 x 9.7 x 1.3 inches (including mic)
Weight:	2200: 10.3 oz. (293 g.) including battery 1200: 10.8 oz. (306 g.) including battery

7. ACCESSORIES

- 56-990 Calibrator Adapter for 0.50 inch diameter microphone for Quest "QC-" series calibrators
- 58-928 Calibrator Adapter for 0.50 inch diameter microphone for Quest "CA-" series calibrators
- 59-344 WS-7 Windscreen for 0.50 inch microphone (pkg. of 3)
- 59-45 Tripod (Larger)
- 59-46 Tripod (Smaller)
- 59-703 Input Adapter - Female BNC jack to 1/2" microphone thread, with 18pF capacitance. Allows direct electrical signal input to the meter.
- 59-899 ICM-2 microphone cable (2 foot length)
- 59-733 ICM-10 microphone cable (10 foot length)
- 59-734 ICM-50 microphone cable (50 foot length)

Service Policy

QUEST SERVICE POLICY

Service Policy

The Quest product you have purchased is one of the finest sound measuring instruments available. It is backed by our full one year warranty which seeks to insure complete customer satisfaction. This is your assurance that you can expect prompt courteous service for your equipment from the entire Quest service organization.

Should your Quest equipment need to be returned for repair or recalibration, please contact the Service Department at (800)245-0779 (USA) or Fax (262)567-4047 for a Return Authorization Number. The RA number is valid for 30 days, and must be shown on the shipping label and purchase order/cover letter. If you are unable to return instruments in that time call for a new RA number. Send it prepaid and properly packed in the original shipping carton directly to Quest Technologies, 1060 Corporate Center Drive, Oconomowoc, WI 53066 U.S.A.

Repair or replacement work done under warranty will be performed free of charge, and the instrument will be returned to you prepaid. Your copy or a photocopy of the Quest Registration Card will serve as proof of warranty should the factory require this information.

If for any reason you should find it necessary to contact the factory regarding service or shipping damage, please direct your calls or letters to the attention of the Service Manager, Quest Technologies, (262) 567-9157 or (800) 245-0779. Office hours are from 7 AM to 6 PM (Central Standard Time) Monday through Friday.

For service or recalibration outside the U.S.A., please contact your local Quest Dealer or fax Quest U.S.A. at 1-262-567-4047.

QUEST WARRANTY POLICY

Warranty Policy

Quest Technologies warrants our instruments to be free from defects in materials and workmanship for one year under normal conditions of use and service. For U.S.A. customers we will replace or repair (our option) defective instruments at no charge, excluding batteries, abuse, misuse, alterations, physical damage, or instruments previously repaired by other than Quest Technologies. Microphones, sensors, and printers may have shorter warranty periods. This warranty states our total obligation in place of any other warranties expressed or implied. Our warranty does not include any liability or obligation directly resulting from any defective instrument or product or any associated damages, injuries, or property loss, including loss of use or measurement data.

For warranty outside the U.S.A., a minimum one year warranty applies to the same limitation and exceptions as above with service provided or arranged through the authorized Quest distributor or our Quest European Service Laboratory. Foreign purchasers should contact the local Quest distributor for details.



Quest Technologies, a 3M company, is a world class manufacturer and leader in the field of occupational safety, industrial hygiene and environmental instrumentation. Quest products are used in more than 80 countries worldwide. Quest has a strong reputation of rugged, reliable instrumentation and software systems that monitor and evaluate occupational and environmental health and safety hazards including noise, vibration, heat stress, indoor air quality and toxic/combustible gases.

Quest monitoring instruments serve a variety of occupations and industries with clients in mining, research, enforcement, military, education, insurance and manufacturing business sectors.

- Visit www.questtechnologies.com for further information.



Occupational Health & Environmental Safety Division

Quest Technologies, a 3M Company
ISO 9001 Registered Company
ISO 17025 Accredited Calibration Lab
1060 Corporate Center Drive
Oconomowoc, WI 53066
Customer Service: 262-567-9157
Toll Free: 800-245-0779



www.questtechnologies.com

Please recycle. Printed in USA.

© 2010 3M

All rights reserved.

056-653, Rev.E 10/10