

**TURNER DESIGNS**

845 W. Maude Avenue • Sunnyvale, CA 94086  
(408) 749-0994 • FAX (408) 749-0998  
Internet: <http://www.turnerdesigns.com>

---

**MODEL 10-AU-005-CE  
FLUOROMETER  
USER'S MANUAL**

**APRIL 1999**

**Part Number  
10-AU-074**

**THIS PAGE INTENTIONALLY BLANK**

# MODEL 10-AU-005-CE FLUOROMETER USER'S MANUAL

## Table of Contents

### Section 1 INTRODUCTION

A. Getting Started .....	1-1
B. Definition of Symbols .....	1-1
C. General Precautions .....	1-1
D. Getting Started--Step-by-step.....	1-3
E. Environment and Operating Conditions .....	1-4
1. Power Requirements .....	1-4
2. Environmental Considerations .....	1-4
3. Mounting Considerations .....	1-5
F. Setting Up Your Fluorometer .....	1-5
1. Sample System .....	1-5
2. Filters & Light Source .....	1-5

### Section 2 OPERATING INFORMATION

A. Overview .....	2-1
B. Controls and Indicators .....	2-2
Figure 1. Model 10-AU Fluorometer Controls & Indicators .....	2-2
C. Before You Use the Software .....	2-3
D. System Activation .....	2-5
The HOME Screen .....	2-6
E. Verifying Operational Parameters .....	2-7
F. Setting the System Clock .....	2-7
G. External Data Logger or Chart Recorder .....	2-7
H. Internal Data Logging .....	2-7
I. Screens Flow Chart .....	2-8

### Section 3 CALIBRATION AND ROUTINE OPERATION

A. Calibration Basics Using the Model 10-AU .....	3-1
B. The Calibration Screen (Screen 2.0) .....	3-2
1. Auto-ranging .....	3-3
2. Table 1. Calibration Screen 2.0 Defaults & Ranges .....	3-4
C. Run Blank (Screen 2.11) .....	3-5
D. Run Standard (Screen 2.3) .....	3-6
1. Screen 2.3 Definitions .....	3-7
2. Screen 2.3 Examples .....	3-8
E. Calibration Preliminaries .....	3-9
1. Temperature Compensation .....	3-9
2. Running Blank and Standard .....	3-9
3. High Blank .....	3-9
4. Direct Concentration Readout .....	3-9

**10-AU-005-CE Fluorometer Table of Contents**  
(continued)

5. Raw Fluorescence Data Readout .....	3-10
F. Calibration Methods .....	3-10
1. Instrument Range and Standard Concentration .....	3-11
Figure 2. Instrument Range and Standard Concentration .....	3-12
2. Recommended Standard Concentration and Instrument Range .....	3-13
Linear Range (Table) .....	3-13
3. Calibration Instructions (Table) .....	3-14
G. Routine Operation .....	3-18
1. Auto-ranging .....	3-18
2. Manual Operation .....	3-18
3. Discrete Sample Averaging .....	3-19
4. Data Logging .....	3-18
5. Sensitivity Setting Retrieval .....	3-20
6. Using Raw Data or Ratio Method .....	3-20

**Section 4 ALARMS AND TROUBLESHOOTING**

A. Alarms .....	4-1
1. Introduction .....	4-1
2. Internal Function Alarms .....	4-1
Table 2. Internal Function Alarms .....	4-1
3. System Alarms .....	4-2
Table 3. System Alarms .....	4-2
4. Alarm Basics .....	4-2
B. Troubleshooting .....	4-4

**Section 5 MAINTENANCE, WARRANTY, AND SERVICE**

A. Maintenance .....	5-1
B. Warranty .....	5-1
C. Obtaining Service .....	5-2
1. Warranty Service .....	5-2
2. Out-of-Warranty Service .....	5-3

**APPENDICES**

**Appendix 1 OPERATING CONDITIONS**

A. Power Requirements .....	A1-1
B. Environmental Considerations .....	A1-2
C. Mounting Considerations .....	A1-2
D. Sample System .....	A1-3
E. 10-AU-005-CE Field Fluorometer Specifications .....	A1-3

**10-AU-005-CE Fluorometer Table of Contents**  
(continued)

**Appendix 2 KEY OPERATING PRINCIPLES OF THE 10-AU**

Figure A1. Optical System of the 10-AU ..... A2-4

**Appendix 3 STUDIES USING THE MODEL 10-AU**

A. Chlorophyll and Pheophytin Studies ..... A3-1  
B. Oil Measurements ..... A3-2  
C. Flow Measurements and Fluorescent Tracer Studies ..... A3-2  
D. Process Control ..... A3-2

**Appendix 4 ACCESSORIES FOR THE 10-AU FLUOROMETER**

A. Batteries for DC Power ..... A4-1  
B. Pumps for Continuous-Flow Systems ..... A4-1  
C. Hoses ..... A4-3  
D. Dye Injection Pumps ..... A4-3  
E. Recorders, Data Loggers, & Computers ..... A4-4

**Appendix 5 OPERATIONAL PARAMETERS & DIAGNOSTIC INFORMATION**

A. Operational Parameters ..... A5-1  
    Table 4. Operational Parameters Defaults & Ranges ..... A5-3  
    1. Screen 1.1: Alarm ..... A5-4  
    2. Screen 1.2: Home Display Options ..... A5-4  
    3. Screen 1.3: Bar Graph ..... A5-5  
    4. Screen 1.4: Output ..... A5-5  
    5. Screen 1.5: Serial Data Out ..... A5-5  
    6. Screen 1.6: Miscellaneous ..... A5-6  
    7. Screen 1.7: Temperature ..... A5-7  
B. Diagnostic Information ..... A5-8  
    1. Screen 3.1 ..... A5-9  
    2. Screen 3.2 ..... A5-10

**Appendix 6 CALIBRATION CONSIDERATIONS**

A. Calibration Considerations ..... A6-1  
B. Setting Basic Operating Level Using the Sensitivity Adjustment Knob .... A6-6  
C. Sensitivity Setting Retrieval ..... A6-13

**Appendix 7 SAMPLE SYSTEM: MAINTENANCE & INSTALLATION**

A. Cuvette Holder Maintenance ..... A7-1  
B. Continuous-Flow Cuvette Maintenance and Leaks ..... A7-2

## **10-AU-005-CE Fluorometer Table of Contents**

(continued)

C. Flow Cell: Condensation and Desiccant Use .....	A7-3
D. Flow Cell External Connections .....	A7-3
E. Removing the Cuvette Holder or Flow Cell .....	A7-5
F. Cuvette Holder or Flow Cell Installation .....	A7-7
G. Water in the Sample Compartment .....	A7-10
<b>Appendix 8 FILTER AND LIGHT SOURCE REPLACEMENT</b>	
Figure A2. Sample Compartment (cover removed) .....	A8-7
<b>Appendix 9 FILTER SELECTION</b>	
A. Theory of Selection .....	A9-1
(Filter Selection Guide follows page A9-2)	
<b>Appendix 10 MODEL 10-AU FLUOROMETER SENSITIVITY</b>	
A. Oil Measurements .....	A10-1
B. Chlorophyll and Pheophytin .....	A10-2
C. Fluorescent Tracer Studies .....	A10-2
<b>Appendix 11 DATA COLLECTION</b>	
A. External Data Logging .....	A11-1
1. Screen 1.4: Output (Voltage Output) .....	A11-1
2. Screen 1.5: Serial Data Out .....	A11-2
Table 6. External Data Logging Defaults and Ranges .....	A11-4
3. Serial Data Output Information for Programmers .....	A11-4
B. Spreadsheet Interface Software (used with external data logging) .....	A11-6
C. Serial Data Collection with a Macintosh Computer .....	A11-7
D. Internal Data Logging .....	A11-10
Table 7. Internal Data Logging Defaults and Ranges .....	A11-16
E. Using the Fluorometer Internal Data Logger Output Program .....	A11-17
F. Examining the Downloaded Data .....	A11-24
G. Power/Telemetry Connector Pins Inputs and Outputs .....	A11-27

**GLOSSARY**

**INDEX**

## Section 1

### INTRODUCTION

#### A. Getting Started

Congratulations on the purchase of your new digital fluorometer! With proper care, it should give you years of reliable service. If, at any time, you need help with your instrument, just call us. We're here to help you.

This manual was written for the 10-AU-005-CE Fluorometer. The step-by-step instructions in Section 1D will help you to get started.

#### B. Definition of Symbols

The symbols below can be found in this manual and notify the user of important safety information:



This terminal can receive or supply an alternating and a direct current or voltage.



This symbol indicates high voltage.



This symbol appears to indicate a "warning" to make note of important safety considerations.

These symbols indicate important user information related to proper operation of the 10-AU and not to user safety:

**NOTE:**

**CAUTION**

#### C. General Precautions

Fluorescence is basically a very safe technology. However, as with any electronic equipment there are some safety issues.



1. **Electrical.** The 10-AU is powered with electrical sources ranges from 90 - 240 VAC; 50/60 Hz. High voltage in the range of 250 to 1000 VDC is present inside the unit's sealed electronic compartment. Perform only procedures described in this manual. To avoid risk of shock, do not attempt to open the sealed case. If the instrument is to be removed from the sealed case (recommended only for trained electronics technicians), before removal **UNPLUG THE UNIT AND WAIT AT LEAST 1 MINUTE.** Avoid contact with exposed electrical circuits.



2. **Ultraviolet Light.** In some applications such as Rhodamine WT and Short Wavelength Oil, the light source is supplied by a clear quartz lamp, which is a source of ultraviolet light. This light can cause permanent damage to the eyes if observed. The lamp is contained in the sample compartment, which prevents any hazard during normal operation. When the sample compartment cover is removed for any reason, a safety interlock switch turns the lamp off. **DO NOT** override this safety switch. You must wear approved protective goggles whenever there is a potential for exposure to ultraviolet light from the quartz lamp. The instrument should be turned off and unplugged before removing or changing the lamp.



3. **Chemicals.** Some applications require the use of fluorescent dyes or solvents such as acetone, or other chemical preparation. Always consult the appropriate Material Safety Data Sheets (MSDS) as supplied by the chemical supplier. **DO NOT** store, handle, or work with any chemicals or hazardous materials unless you have received appropriate safety training and have read and understood all related MSDS. Work in a well ventilated area, use chemicals in accordance with all federal, state, and local regulations related to chemical storage, handling, and disposal, and limit exposure to hazardous chemicals.

When performing discrete sample measurements, use capped test tubes whenever possible to prevent the spill of any volatile or other potentially harmful chemicals. Where capped test tubes are not available, use Parafilm™ to prevent spills.

Note that the 10-AU-005-CE's electronics are sealed so that they are protected from damage or hazard in case of a spill inside the sample compartment. In addition, the lamp compartment is separated from the sample compartment to prevent damage to the lamp components in case of a spill or leak.

**CAUTION**

4. The 10-AU-005-CE and its accessories are designed for use in freshwater and marine environments. When using the continuous flow cuvette system, **DO NOT** use organic solvents such as acetone, methanol, or pyridine, or corrosive materials such as strong acids and bases in the flow cell.



**D. Getting Started--Step-by-step**

This step-by-step procedure will help you carry out your FIRST study. After you have been through the procedure once, you will probably only need to do steps 8, 9, and 10 for future studies.

**Before using your fluorometer, review Section 1B and 1C above for important safety information.**

1. Please fill out and return the warranty sheet at the beginning of this manual. Timely return of this information will ensure that you receive prompt notice of new features, accessories, and literature.
2. Make sure you have everything you ordered by checking your shipment against the packing list. In the unlikely event something is missing, call us at once so we can help resolve the discrepancy.

Details about your instrument's set-up (it lists things installed by Turner Designs before shipment) can be found in the Instrument Set-Up Form in the front of this manual.

3. If fluorescence is new to you, before starting you may want to read Appendix 2, Key Operating Principles.
4. Review Section 1E. This will tell you how to supply power to your instrument and things to consider about mounting and environment. Section 1F concerns the sample system, filters, and light source.
5. Review Section 2. This contains locations and definitions of controls and items appearing on the digital display. You might find Figure 1 (Section 2B) and the Screens Flow Chart (Section 2I) particularly useful.

If you like, turn on the Model 10-AU and "page" through the screens as you review them in the manual.

Section 3A discusses how the Sensitivity Adjustment Knob, ranges, and Span function work together to set the sensitivity of your instrument.

Section 3B defines terms on the calibration screen 2.0.

6. If you wish to reset any of the operational parameters, do so at this time. See Appendix 5A for details.

7. Before calibrating your instrument for the FIRST time, you will need to set the basic operating level of your instrument using the Sensitivity Adjustment Knob. See Appendix 6B for step-by-step instructions.
8. Consider your data logging options. See Appendix 11, sections A, B, and C, for external data logging options. See Appendix 11, sections D and E, for internal data logging.
9. Calibrate your instrument. See Sections 3F.
10. You are ready to run samples. See Section 3G for routine operation.

## **E. Environment and Operating Conditions**

### 1. Power Requirements

The 10-AU-005-CE will operate on standard 115 VAC, 230 VAC (+/-10% of the nominal voltage), 50/60 Hz, or DC power. The power cable you specified is included with the accessories.

To supply power, simply screw the appropriate power cable onto the power/telemetry connector at the front of the instrument (see Figure 1, Section 2), and attach it to the desired power source.



**If using DC power and a battery**, please note that the DC Power Cable with alligator clips is for portable and temporary connection only; it is **NOT** for permanent connection or marine use. For permanent connection or marine use, use the Marine Battery Cable only.

### 2. Environmental Considerations

**Temperature.** Storage temperature is -20°C to +60°C. The minimum operating temperature is 5°C; the maximum is 40°C ambient.

## **NOTE:**

**Water and Dirt.** Your fluorometer will arrive in a laboratory or a field case. Both cases are sealed to prevent water from reaching the electronics. In the field case, with the continuous-flow cuvette installed, the fluorometer will withstand waves, rain, and splashing, and can be washed off with water. The unit is **not** designed for submersion.

The inside of the Sample Compartment should be kept clean and dry. (See Appendix 7 for what to do if there is a spill.)

**Movement or Vibration.** The instrument can be moved and will not be affected by moderate vibration.

**CAUTION**

**Helium.** If you are working with exotic breathing mixtures, or other systems using helium, keep them away from the fluorometer because they can cause damage to the photomultiplier.

**Altitude Specification:** 0 - 2000 m.

**Transient Overvoltages:** According to Installation Category II.

**Pollution Degree 2** in accordance with IEC 664.

3. Mounting Considerations

**Mounting Position.** For maximum stability and proper cooling of the light source, the average position of the instrument should be within 20 degrees of level.

**Mounting Considerations.** During normal operation, only access to the front panel is required, but be sure to allow sufficient space for easy cuvette insertion, or for cleaning the flow cell. Watch overall temperature in enclosed racks; temperature should be kept low and constant.

F. **Setting Up Your Fluorometer**

1. Sample System

The Model 10-AU-005-CE is configured for use with the continuous-flow cuvette system. Unless otherwise requested, your fluorometer has been shipped with the 25 mm Continuous-Flow Cuvette System installed.

The 10-AU-005-CE will also operate with a cuvette holder for discrete (test tube) samples. If you wish to use the Discrete Sample Cuvette Holder, it should be installed at this time. (See Appendix 7.)

2. Filters and Light Source

The filters and light source are installed by Turner Designs for your main application (i.e., Rhodamine, chlorophyll, oil, etc.). If you change applications, you will need to change the lamp and filters. (See Appendices 8 and 9.)

**THIS PAGE INTENTIONALLY BLANK**

## Section 2

### OPERATING INFORMATION

#### A. Overview

(See Appendix 2 for a discussion of operating principles.)

**Please refer to Section 1 for important safety information.**

The Model 10-AU Fluorometer has been designed so that no internal controls will require setting during normal operation of the instrument. All operating controls and indicators are on the front panel. (Refer to Figure 1.)

Operation of the Model 10-AU is straightforward. It consists of four basic steps:

1. **Activation and initial verification of operational parameters.** Activation involves supplying power (see Section 2E). At the time of manufacture, the fluorometer was programmed with various default operational values (see Appendix 5A). The default values should be reviewed to make sure they are appropriate for your application. Once set, you should not have to reset them unless the requirements for your study change.
2. **Setting the basic operating level.** Before calibrating for the first time, you must set the basic operating level of the fluorometer using the Sensitivity Adjustment Knob (see Appendix 6B.) Thereafter, you will set sensitivity during calibration using the keypad.
3. **Calibration.** Calibration consists of setting the sensitivity of the instrument to a level appropriate to your samples and blank, i.e., adjusting the range of concentrations you can read. Where direct concentration readout is desired, a sample of known concentration must be used as a standard. (See Section 3.)
4. **Running samples.** (See Section 3G, Routine Operation.)

**B. Controls and Indicators**

**LIGHT CAP.** Used with the Discrete Sample Cuvette Holder. It prevents external light from falling on the light detector. Keep in place even when the instrument is not in operation to prevent dirt and moisture from entering the Sample Compartment.

**SAMPLE COMPARTMENT.** Where Discrete Sample Cuvette Holder or Flow Cell is installed. It also contains the lamp and filters.

**DIGITAL DISPLAY.** The liquid crystal display (LCD) shows the screens, and displays the HOME screen. The backlight can be turned on by pressing a key on any screen. The backlight will go off automatically when a user-set time (from 10 - 3600 seconds) expires after the last keypress. (*Appendix 5A, screen 1.61.*)

**4 AMP FUSE (DC POWER).** Fuse can be changed by pushing in and turning counter-clockwise. **NOTE:** There is no AC fuse. A transformer on the AC power cable converts AC to DC.

Contrast of the LCD can be adjusted by pressing the up or down arrow on most screens. If the **screen is dark or dim** when your fluorometer is turned on, check the contrast first.

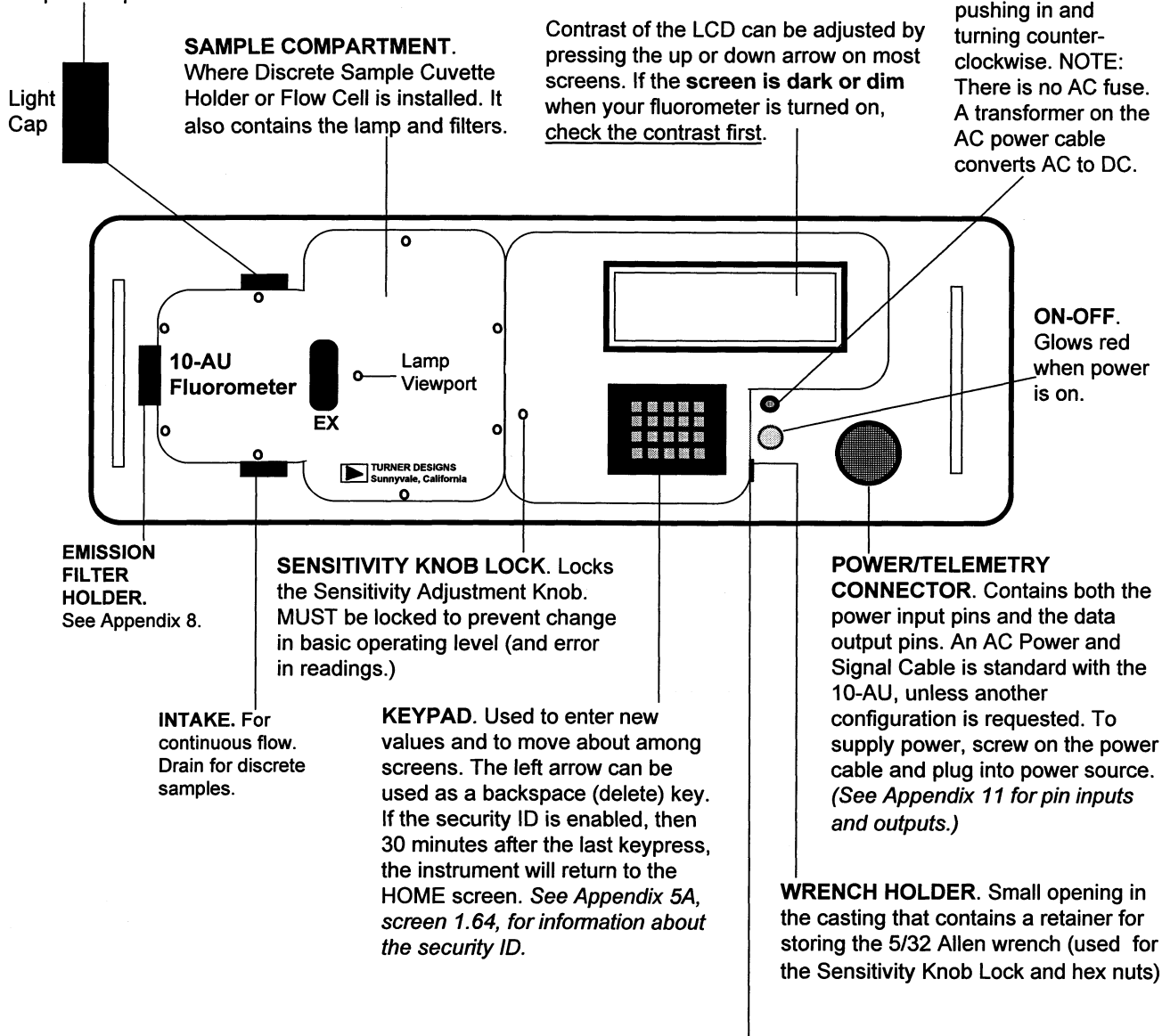

**EMISSION FILTER HOLDER.** See Appendix 8.

**SENSITIVITY KNOB LOCK.** Locks the Sensitivity Adjustment Knob. **MUST** be locked to prevent change in basic operating level (and error in readings.)

**INTAKE.** For continuous flow. Drain for discrete samples.

**KEYPAD.** Used to enter new values and to move about among screens. The left arrow can be used as a backspace (delete) key. If the security ID is enabled, then 30 minutes after the last keypress, the instrument will return to the HOME screen. See Appendix 5A, screen 1.64, for information about the security ID.

**POWER/TELEMETRY CONNECTOR.** Contains both the power input pins and the data output pins. An AC Power and Signal Cable is standard with the 10-AU, unless another configuration is requested. To supply power, screw on the power cable and plug into power source. (*See Appendix 11 for pin inputs and outputs.*)

**WRENCH HOLDER.** Small opening in the casting that contains a retainer for storing the 5/32 Allen wrench (used for the Sensitivity Knob Lock and hex nuts).

**SENSITIVITY ADJUSTMENT KNOB.** This recessed black screw sets the basic operating level (sensitivity) of the instrument, and is locked into position by the Sensitivity Adjustment Lock. The level must be set **BEFORE** calibrating for the first time. Thereafter, lock it down and **DO NOT** adjust unless you want to change the operating level significantly, or unless you change to a different optical filter kit. After the initial adjustment of this knob, sensitivity will be set during calibration using the keypad. You **MUST** recalibrate your instrument if the knob is adjusted. See Appendix 6B for instructions.

**FIGURE 1. 10-AU-005-CE Fluorometer Controls & Indicators**

**C. Before You Use the Software (Screens Overview)**

When using the software for the Model 10-AU Fluorometer, you should familiarize yourself with a few basic instructions, which will prevent frustration and greatly speed your comprehension of the system.

1. Screens. Built into the fluorometer are a series of computerized screens, which are called up using the keypad and shown on the digital display. For easy identification, the **active screens** have an identification number in the **lower or upper right-hand corner**.

Instructions and changes are entered on the keypad.

2. HOME Screen. Once the system has been activated, the HOME screen is continuously displayed (except when accessing other screens).

If the security ID is enabled, then 30 minutes after the last keypress, the instrument will return automatically to the HOME screen and the security ID will have to be re-entered before any other screens can be accessed. See Appendix 5A, screen 1.64.

If an alarm is activated when the instrument is operating, the words "ALARM ON!" will flash in the upper right hand portion of the HOME screen. Press <ESC> to access the alarm screen.

You can **go to the HOME screen by pressing <HOME>**, except while in a help screen. **You must first exit the help screen by pressing <ESC>**.

3. Digital Display contrast. The contrast of the LCD can be adjusted on any screen, except screen 2.11 (Run Blank) and screen 2.3 (Run Standard solution), by pressing the up or down arrows.

**NOTE:** If the screen is dark or dim when your fluorometer is turned on, check the contrast first. It is possible that the contrast has been decreased so much that the screen is too dark to view.

4. Main Menu. From the HOME screen, you can access the Main Menu by pressing <ENT>. From the Main Menu, the active screens may be accessed. (See the screens flow chart, following this section.)

**NOTE:** If the security ID is enabled, the fluorometer will ask for an ID entry before access to screens other than HOME is allowed. See Appendix 5A, screen 1.64.

## **Model 10-AU-005-CE Fluorometer User's Manual**

5. Moving through screens. The screens provide instructions on how to move back and forth between them; in most cases you use <ENT>. Pressing the number for a menu item accesses the screen for that function.

You can escape to the previous screen by pressing <ESC>.

6. Left arrow. The **left arrow** can be used to **correct typing** errors when data are being entered or changed. It acts as a backspace or delete key.
7. HELP screens. The HOME screen, the Main Menu, and the calibration screens have help screens, called up by pressing <?>, which list the commands and instructions for the screens.

NOTE: You MUST exit the help screen by pressing <ESC>, before keying other commands. The system will ignore commands given unless the help screen is exited first.

8. Warning screens. There are warning screens throughout, which will alert you to invalid entries.
9. Alarm screen. An alarm screen indicates what alarm(s) has been triggered and diagnostic screens provide information on various internal fluorometer functions. (See the Alarms & Troubleshooting section.)
10. Response delay. Under certain conditions (i.e., when sensitivity is adjusted, or instrument settings are changed, etc.), the **digital display will not react immediately** to the change, but will respond after a delay of about 10 seconds.

The software has been thoroughly tested so it is unlikely, though not impossible, that what appears to be a software malfunction is actually an inconsistency being entered into the system.

For an overview of the screens, see the screens flow chart at the end of this Section.



**D. System Activation**

The Model 10-AU Fluorometer is activated by supplying power and turning the instrument on. The "Turner Designs" screen will appear. The HOME screen will appear after 10 seconds, or you can press <ENT> to bring up the HOME screen immediately.

**NOTE:** After some years use, a warning screen will appear concerning the start-up test and non-volatile data (NVRAM). This indicates that the fluorometer internal computer battery for data storage may be low. Refer to Section 4, Alarms & Troubleshooting for details.

When the system is activated, the HOME screen will be continuously displayed.

**The HOME Screen**

Concentration range (CONC) and whether you are operating in the AUTO or MANUAL mode. (Set range on screen 2.42; AUTO/MAN on screen 2.43.)

Time constant (see definition under screens 2.11 and 2.3)

At the option of the user, HOME may also display an analog bar graph (access screen 1.3 to change zero and full scale points, or set to auto-scale). (See Appendix 5A, screen 1.3)

Pressing <\*> initiates the Discrete Sample Averaging sequence, which averages the readings over a user-settable period, and freezes the digital display for 10 seconds so you can note the reading. Thus, each sample can be read after the same amount of time has passed; and the averaging and freezing of the display minimizes both the inconvenience and potential error when readings fluctuate. When <\*> is pressed, the words "Delay," then "Ave," and finally "DONE" will appear just above the units of measurement during the sequence. (See Appendix 5A, screen 1.63.)

Sample reading (with user-settable units), accurate after proper calibration. The screen can display a maximum of 3 digits, rounded off from the readings on screen 3.2 (which can support 7 digits (XXXX.XXX) for each range.) A reading greater than 999 will flash ">999". (See Appendix 5B, screen 3.2 for a discussion of the significance of digits.)

From screen 1.22, you may select a unit designation for your readout. (See Appendix 5A, screen 1.2.) You may also elect to display raw fluorescence data or direct concentration (accurate after proper calibration. If RAW is chosen, "(RAW)" will appear as the unit designation. (Appendix 5A, screen 1.21).

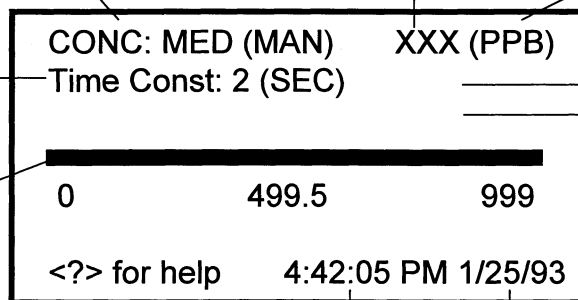

If an alarm is activated when the instrument is operating, the words "ALARM ON!" will flash here, and the audio alarm will beep unless you have turned off the beeper. Press <ESC> to view any active alarms. (See Section 4, Alarms & Troubleshooting.)

If you have purchased the optional internal data logger, the words "LOGGING DATA" will appear when data is being logged. (See Appendix 11E.)

Call up the Full Scale Value Table indicating the maximum concentration (or raw fluorescence signal) that can be read on each range under the current calibration. (See Section 3D, screen 2.3.)

Press <ENT>+

- MAIN MENU**
1. Operational parameters:
  2. Calibration:
  3. Diagnostic information:
  4. Clock:
  5. Internal data logger:\*\*
- <?> for help

+ If the security ID is enabled, you will be prompted for ID entry before you are allowed access to the MAIN MENU. (See Appendix 5A, screen 1.64.) It is the policy of Turner Designs to provide ID access information by phone if a user requests it.  
 \*\* Appears only if you have purchased this option.

**E. Verifying the Operational Parameters**

The basic operational parameters have been set by Turner Designs with default values. It is possible that they may not need to be changed.

There are, however, several convenient options and you should review them initially to familiarize yourself with them, and to verify that they are set correctly for your study. (See Appendix 5A for review and instructions.)

**F. Setting the System Clock**

The system clock indicates the date and time, in hours, minutes, and seconds.

To set the system clock, from the HOME screen press <ENT> to call up the Main Menu. Press <4> on the Main Menu, and follow instructions.

NOTE: If you have purchased the optional internal data logging capability, and data logging is in process using the "One Way" strategy (see Appendix 11E, screen 5.3), to prevent error, the instrument will not allow you to reset the clock.

**G. External Data Logger or Chart Recorder**

Data collection via an external data logging device or a chart recorder is an option for the Model 10-AU-005-CE. Data logging is both convenient and useful, especially in continuous-flow studies, if important data are not to be missed.

An analog signal output (user may choose a full scale output of 0.1, 1, 2 or 5 volts) is available, as is a digital output through an RS-232 serial port. There is an optional real time serial data output, which can be operated manually from the HOME screen. (See Appendix 11A, screens 1.4 and 1.5 for further information.)

**H. Internal Data Logging**

Internal data logging is an option on the Model 10-AU-005-CE Fluorometer. The user can log up to 64,800 data points (depending on the data logging parameters selected), including fluorescence and temperature (if the optional temperature-compensation package has been purchased). Data are retrieved through an RS-232 serial port by a PC. A software program is provided for downloading and converting the data into a Lotus-readable format.

If you have purchased this option, internal data logging parameters can be accessed through the Main Menu by pressing <5>. For an explanation of the various parameters, see Appendix 11D.



# Section 2 OPERATING INFORMATION

## I. Screens Flow Chart

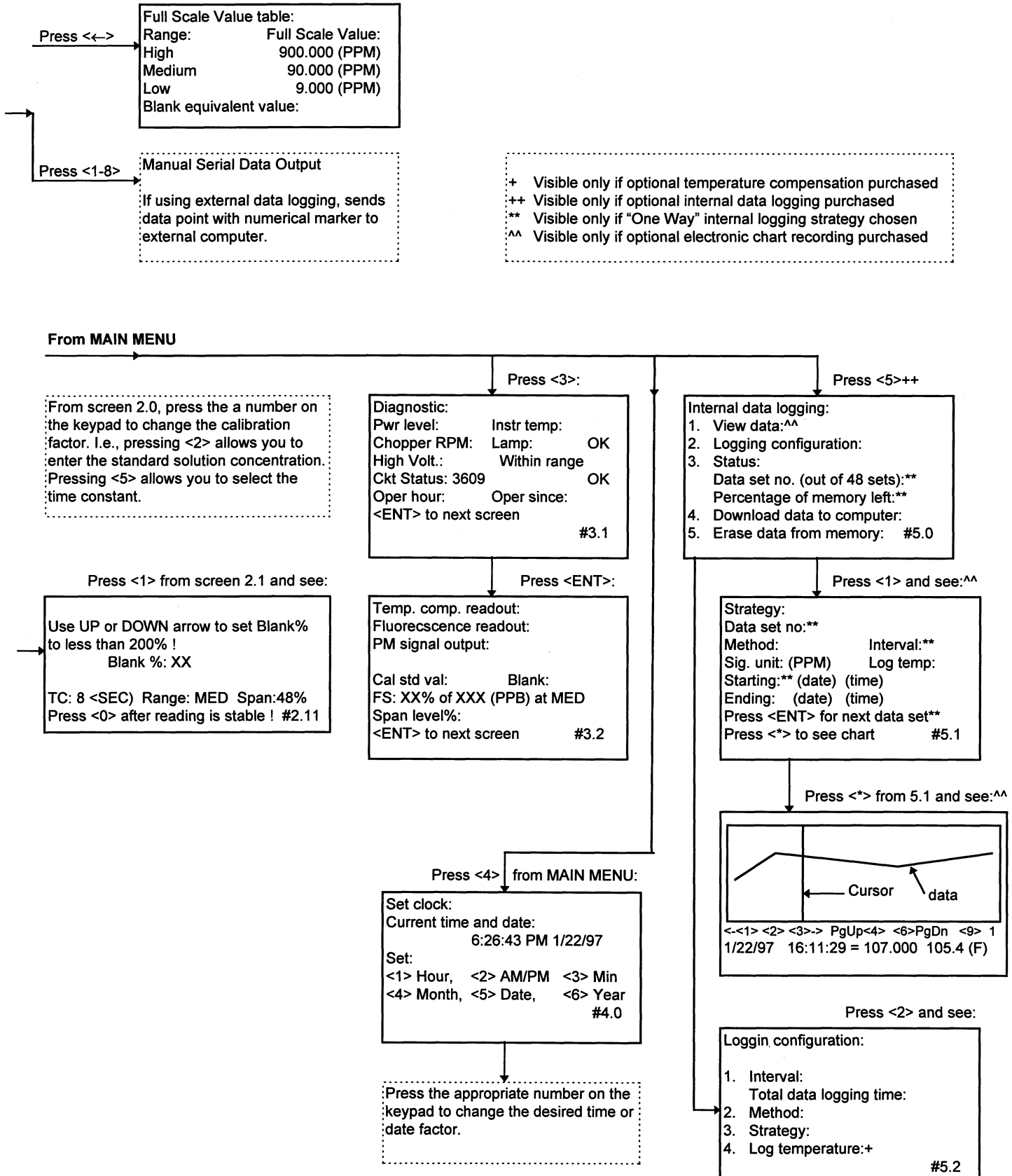

**(THIS PAGE INTENTIONALLY BLANK)**

## Section 3

### CALIBRATION AND ROUTINE OPERATION

#### A. Calibration Basics Using the Model 10-AU

Section 2 contains important information about the operation and features of the Model 10-AU-005-CE.

Calibration consists of compensating for blank (solution containing zero concentration of the substance to be read) and adjusting the Model 10-AU reading to reflect a known concentration of sample (the standard). During calibration you can adjust the sensitivity (Span) so you can read a desired range of concentrations.

Sensitivity of the Model 10-AU is adjusted in three ways:

- a. The basic operating level of your Model 10-AU must be set using the Sensitivity Adjustment Knob before you calibrate your instrument for the first time. (See Appendix 6B.) Thereafter, DO NOT ADJUST the Sensitivity Adjustment Knob unless you change applications or cuvette size. (See Appendices 7 and 8.)
- b. During calibration, the autoranging function will select the appropriate instrument range for the standard and blank. Instrument ranges (HIGH, MEDIUM, or LOW concentration ranges) are in factors of 10. As an alternative, you may set the instrument to manual range and select the range for running your standard and blank. Then, once calibrated, you may set the instrument for auto-ranging, and let it choose the best range. (See Auto-ranging, Section 3B1.)
- c. During calibration, minor adjustments may be made to sensitivity on screen 2.3 using the Span function (UP and DOWN arrows).

If you are an experienced practitioner of fluorescence studies, you can proceed immediately to Section 3B.

If, however, fluorescence measurements are new to you, note that certain factors, such as temperature and the linear range of your sample, are critically important for accurate studies. When using a cuvette holder, variations from test tube to test tube can affect your readings. Please read Appendix 5A carefully before calibrating your fluorometer for the first time.

**B. The Calibration Screen (Screen 2.0)**

From the HOME screen, press <ENT> to call up the Main Menu. Press <2> on the keypad (Calibration) from the Main Menu. The calibration screen will appear.

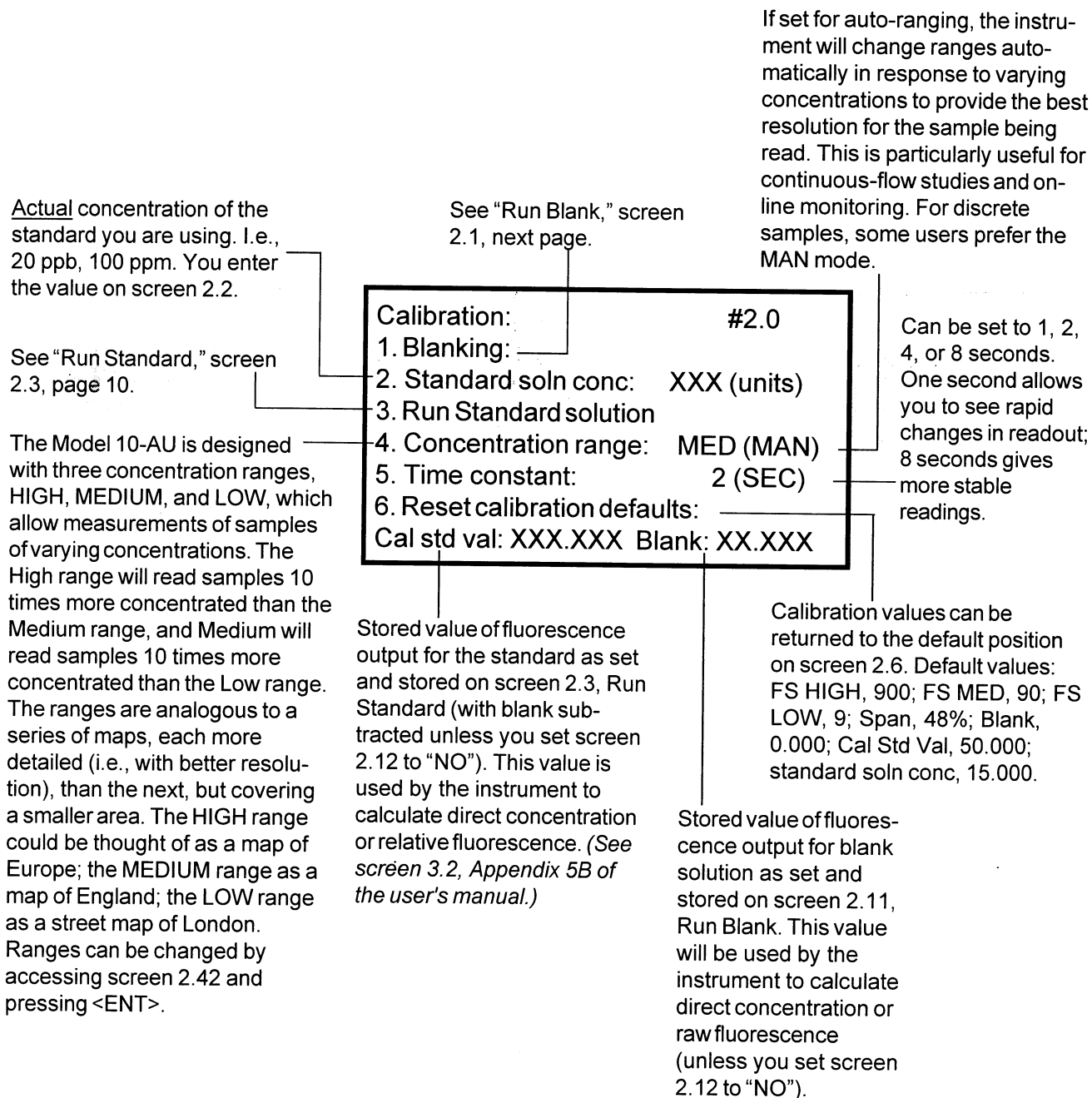



## Section 3 CALIBRATION AND ROUTINE OPERATION

### 1. Auto-ranging

Auto-ranging is a unique feature of the Model 10-AU-005-CE. If set for auto-ranging, the instrument will change ranges automatically in response to varying concentrations to provide the best resolution for the sample being read.

If a sample reads greater than 95% of full scale on one concentration range, and remains there for at least 3 seconds with a stable signal, the instrument will automatically reduce the sensitivity of the instrument by changing to a less sensitive range: i.e., if the reading is greater than 95% of full scale on the LOW range, the Model 10-AU will automatically change to the MED range.

If a sample reads less than 8% of full scale on one concentration range, and remains there for at least 3 seconds with a stable signal, the instrument will automatically increase the sensitivity of the instrument by changing to a more sensitive range: i.e., if the reading is less than 8% of full scale on the HIGH range, the Model 10-AU will automatically change to the MED range.

To change your 10-AU from auto-ranging to manual or vice versa, access screen 2.43, and press <ENT> to select AUTO or MAN. When AUTO is selected, the words "(AUTO)" will appear on the HOME screen in the upper left corner next to the concentration range (unless you have turned off the range display on screen 2.41).

When the instrument is operating in AUTO and it changes ranges, the audio alarm will beep and AUTO will alternate from AuTo to aUtO while the range is changing. The sample concentration reading will freeze at the current level for 5 seconds to avoid fluctuation in readings, and the time constant will revert to 1 second for a quicker response.

NOTE: If the Model 10-AU changes ranges when data is being logged with an external data collection device (serial or voltage output), the "frozen" reading from the HOME screen is what will be recorded. (See Appendix 11.)

During calibration, even though the instrument is set to AUTO, the auto-ranging function will be **disabled** while on the Run Blank (screen 2.11) and Run Standard (screen 2.3) screens. Note that the instrument will probably change ranges when the light cap is removed after you exit screen 2.11, and before you enter screen 2.3. For accurate readings, it is important to follow step-by-step instructions in Section 3F.

2. Calibration Screen (Screen 2.0) Defaults & Ranges

<u>Value</u>	<u>Default</u>	<u>Range</u>
Std Soln Conc.	15.000	0.00 - 999.999
Concentration Range	MED	LOW, MED, HIGH
Concentration Range Control	MAN	AUTO/MAN
Time Constant	2 (SEC)	1, 2, 4, 8 (SEC)
Cal std val	50.000	0 - 9999.999
Blank	0.000	0 - 9999.999
Span	48%	0 - 99%

## Section 3 CALIBRATION AND ROUTINE OPERATION

### C. Run Blank (Screen 2.11)

**BLANKING.** Blank is run on screen 2.11. Access screen 2.11 by pressing <1> from screen 2.0, then <1> again. Before measuring sample, a blank should always be collected. A blank is a sample of the water or solvent solution you will work with, taken before any of the substance to be measured has been added. This fluid should be the matrix for your standard and will be used to set the instrument to read zero. (See Section 3F for step-by-step calibration instructions.)

**SUBTRACT BLANK.** From the calibration screen 2.12, you can decide whether or not you would like the instrument to subtract blank. A "NO" setting on screen 2.12 means only that instrument will not subtract blank for you (even if you Run Blank on screen 2.11). A "YES" setting on screen 2.12 means that the instrument will subtract blank as run on screen 2.11.

The maximum blanking capability is 200% of full scale (300%), i.e., about 67% of the available signal can be used for blank, leaving 33% for samples (more than sufficient given the fluorometer's sensitivity). Once blanking is accomplished on one range, it is set for all ranges. The Model 10-AU automatically compensates for changes in concentration ranges. It is not necessary to adjust the Blank% to any particular number, as long as it is less than 200%. A low percentage number is preferred. (NOTE: The instrument will NOT prevent you from exceeding 200%.)

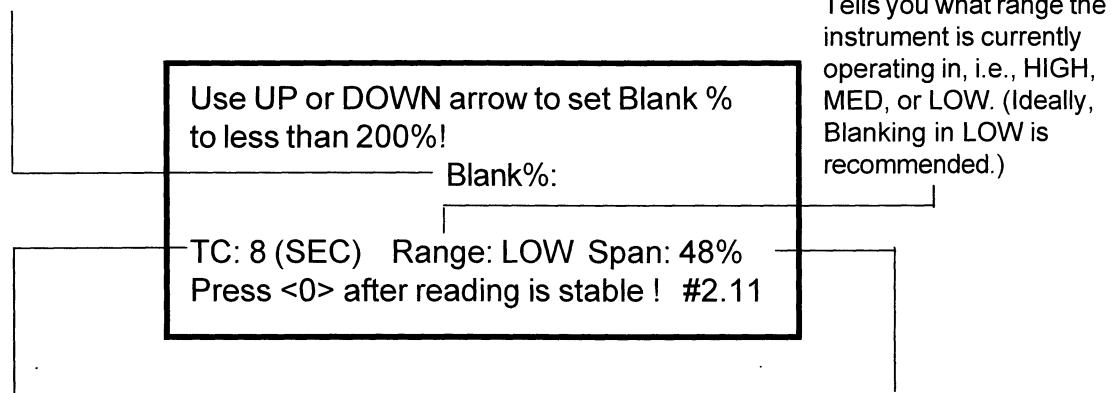

**TIME CONSTANT (TC).** Note that during calibration, when Span is being adjusted and  $\uparrow$  or  $\downarrow$  is pressed, the TC will automatically cycle through the TC values, beginning with 1 second to give you the fastest response time, then moving to 2, 4, and finally 8 (most stable and accurate). During calibration, if  $\uparrow$  or  $\downarrow$  is not pressed, the TC remains at 8.

Equivalent to a fine adjustment of sensitivity. Span is adjusted in a continuous manner by pressing  $\uparrow$  or  $\downarrow$ . Press  $\langle\uparrow\rangle$  to increase Span and  $\langle\downarrow\rangle$  to decrease it. When minimum sensitivity is reached, the words " $\langle\text{MIN SEN}\rangle$ " will appear just above the Span; " $\langle\text{MAX SEN}\rangle$ " will appear above the Span when maximum sensitivity is reached.

#### **D. Run Standard (Screen 2.3)**

During calibration, the standard is run on screen 2.3. The Span may be adjusted if desired using <↑> and <↓> until the readings on the Full Scale (FS) Value table are satisfactory for your study. (See screen 2.3, next page.) However, if the basic sensitivity has been set according to instructions in Appendix 6B, adjusting the Span is probably unnecessary.

Normally, your standard will be a known concentration of the fluorophore of interest. For single-point calibrations, and where a known concentration is needed, we recommend you choose a standard with a concentration approximately 80% of the highest concentration you are reading, but still well within the linear range for your substance. (See Appendix 6A, Linearity.)

If you wish to read concentrations above the linear range, several standards should be used so a calibration curve may be prepared. For example, if your substance is linear to 250 ppb (parts per billion), and measurable with a calibration curve to 1000 ppb, you could calibrate with a 200 ppb standard, and take readings at 500, 750, and 1000 ppb for a calibration curve.

Calibration With a Sample of Unknown Concentration. In some procedures, *in vivo* chlorophyll or certain flow measurements, you will be calibrating with an unknown concentration. For *in vivo* chlorophyll measurements, for example, in most cases you will be calibrating with an unknown sample from the body of water you are investigating. During the calibration procedure, while sample ("standard") is flowing through the instrument and being run on screen 2.3, you should take a grab sample of the water immediately after it passes through the flow cell for later extraction to determine actual chlorophyll concentration. (**Important:** Record the *in vivo* fluorescence reading of the "standard" as it passes through the flow cell.) You will then use a ratio method to compare all other readings with the "standard." Applying the procedures set forth in Section 3F, on screen 2.2, call your "standard" 10 or 100. Blank should be run on screen 2.11, as described. When you run your standard, use the "raw data" method.

Say, for example, you called your standard "10" on screen 2.2. Later, the standard concentration is determined by extractive methods to be 5 ppb of chlorophyll. If an unknown in the field read 12 as compared to the standard you called "10", the actual concentration of the unknown would be 6 ppb ( $5 \text{ ppb}/10 \times 12$ ).

## Section 3 CALIBRATION AND ROUTINE OPERATION

### 1. Screen 2.3 Definitions

**Full scale table (FS)\*.** The table on screen 2.3 indicates full scale (FS)--the maximum concentration or raw fluorescence data that can be read on each of the three ranges at the current Span level. Keep in mind that the numbers are full scale values, and it is not necessary or likely that the FS values will match the concentration of your standard.

The table can support 7 digits (XXXX.XXX) for each range. The HOME screen can accommodate only three (XXX; XX.X; X.XX, .XXX). Thus readings on the HOME screen will be rounded off to 3 digits. (See Appendix 5B for reading to 7 digits on screen 3.2.)

Once set, values can be viewed by pressing <-- (LEFT arrow) from the HOME screen. Reset table to default from screen 2.6.

**BLK > FS** means that blank is higher than full scale on that range. You will not be able to use that range for sample readings. This is acceptable if blank is high and you want to read high concentrations, if the FS on the higher ranges is acceptable. (See Section 3E3 for a way of handling high blank.)

**OVER** means that the signal from the standard exceeds the sensitivity level of the instrument for that range. Reduce Span or go to a higher range. (See Section 3F.)

**>9999** means the reading exceeds the maximum number of digits allowed. (See Section 3F.)

Press <-- (LEFT arrow) from HOME screen to view Full Scale Value Table.

Read help <?> before running Standard!  
Use UP or DOWN arrow to adjust Table

RANGE:	High	Medium	Low
FS (PPB):	900.000	90.000	9.000

Tells you what range the instrument is currently operating in, i.e., HIGH, MED, or LOW.

TC: 8 (SEC) Range: MED Span: 48%  
Press <\*> after reading is stable ! #2.3

**TIME CONSTANT (TC).** During calibration, when Span is being adjusted with the <UP> or <DOWN> arrows, the TC will automatically cycle through the TC values, beginning with 1 second to give you the fastest response time, then moving to 2, 4, and finally 8 (most stable and accurate). During calibration, if the <UP> or <DOWN> arrows are not pressed, the TC remains at 8.

Span is a fine adjustment of sensitivity. If desired, Span may be adjusted by pressing the <UP> or <DOWN> arrow to increase or decrease sensitivity. NOTE: FS values increase as Span is decreased, and vice versa. When minimum sensitivity is reached, the words "<MIN SEN>" will appear just above the Span; "<MAX SEN>" will appear above the Span when maximum sensitivity is reached. If you exceed 200% for blank as currently calibrated, a warning will appear: "BLANK is more than 200%. REDUCE span!" *The instrument will not prevent you from exceeding 200% for blank.*

**\*Screen 2.3 FS Table Defaults and Ranges**

Concentration Range	FS Default	Range
LOW	9.000	0 - 9999.999
MED	90.000	0 - 9999.999
HIGH	900.000	0 - 9999.999

If you choose to have blank subtracted (YES on screen 2.12), the FS table readings for each range will not differ by precisely a factor of ten, because, depending on the range, blank will take up a different proportion of the total dynamic range of the instrument.

2. Screen 2.3 Examples

**Screen 2.3: Example "BLK>FS"**

Read help <?> before running Standard!  
Use UP or DOWN arrow to adjust Table  
RANGE: High Medium Low  
FS (PPB): 853.512 85.351 BLK>FS  
  
TC: 8 (SEC) Range: MED Span: 48%  
Press <\*> after reading is stable ! #2.3

**BLK>FS** means that the blank is higher than full scale on this range. You will not be able to use this range for sample readings. This is acceptable if blank is high and you want to read high concentrations, if the FS on the higher ranges is acceptable. (See Section 3E3.)

**Screen 2.3: Example "OVER"**

Read help <?> before running Standard!  
Use UP or DOWN arrow to adjust Table  
RANGE: High Medium Low  
FS (PPB): OVER OVER OVER  
  
TC: 8 (SEC) Range: MED Span: 48%  
Press <\*> after reading is stable ! #2.3

**OVER** means that the signal from the standard exceeds the sensitivity level of the instrument for that range. If in the HIGH range, refer to Appendix 6B to reset basic operating level before recalibrating. (See also Calibration Procedure, Section 3F.)

**Screen 2.3: Example ">9999"**

Read help <?> before running Standard!  
Use UP or DOWN arrow to adjust Table  
RANGE: High Medium Low  
FS (PPB): >9999 1100.000 110.000  
  
TC: 8 (SEC) Range: MED Span: 48%  
Press <\*> after reading is stable ! #2.3

**>9999** means the reading exceeds the maximum number of digits allowed. (See Calibration Procedure, Section 3F.)

E. Calibration Preliminaries

**NOTE:**

Before calibrating, make sure that no internal function alarms are activated by checking the HOME screen. (High or low level alarms can be ignored. See the Alarms & Troubleshooting section.)

**CAUTION**

After turning on the power, wait a minimum of 10 minutes before calibration to allow the instrument to stabilize.

1. Temperature compensation. If you have purchased the temperature-compensation package, and are working with the continuous flow-cuvette, you will need to set the temperature-related values for your study. See the Definitions section of Appendix 5A, screen 1.7. These must be set before calibration. Note that YOU MUST RECALIBRATE whenever you change the temperature format or coefficient, or the reference temperature.

2. Running Blank and Standard.

On the 10-AU, blank and standard are run independently of each other on screen 2.11, Run Blank, and screen 2.3, Run Standard Solution. Thus, once they are set, if you want to recalibrate using a new standard but the same blank, you only need to rerun the new standard on screen 2.3. If, however, you use a new blank, re-run both the blank and the standard.

It is good practice to set blank first, then the standard. Blank often determines the concentration range, especially in cases of high blank, and changing the blank will affect the full scale readings for your samples.

NOTE: If you do not want the instrument to subtract blank (a "NO" setting on screen 2.12), then you do not need to Run Blank (screen 2.11).

3. High Blank. If blank is high, you may want to consider treating the high "blank" as another sample. For example, you might calibrate using distilled water as a true blank, take a reading for the high "blank" as if it were another sample, and then subtract that value manually from all your other sample readings. This method will prevent negative readings for samples (meaning they are reading less concentrated than your "blank.")
4. Direct concentration readout. When properly calibrated, the readout on the HOME screen is the direct concentration of your sample. The 10-AU contains a microprocessor, which takes the photomultiplier signal output for the sample, standard, blank, concentration range, and absolute concentration of the standard; and performs all calculations necessary. (See screen 1.21, Appendix 5A.)

5. Raw fluorescence data readout. If you like, you can choose to view the readout for your samples as raw fluorescence data. This means that what you are interested in reading is the relative fluorescence (fluorescence proportional to concentration) of one sample compared to another, rather than actual concentration. If this option is selected, the words "RAW" will appear next to the readout on the HOME screen, without a unit designation. The table on screen 2.3, Run Standard solution, will display "FS (RAW)" at the middle left, and indicate the full scale raw fluorescence readings. As with direct concentration, you can choose whether or not to have blank subtracted.

The calibration procedure is basically the same as for direct concentration, except that on screen 2.3, a standard is useful for adjusting the Span until the sensitivity is adequate for your study, rather than equating raw fluorescence units to a known concentration.

To select direct or raw fluorescence readout, access screen 1.21. (See also the definitions in Appendix 5A, screen 1.2.)

#### **F. Calibration Methods**

**NOTE:** You must set the basic operating level of the fluorometer using the Sensitivity Adjustment Knob BEFORE CALIBRATING YOUR FLUOROMETER FOR THE FIRST TIME. (See Appendix 6B.) Thereafter, it is not necessary to adjust the Sensitivity Knob unless you change cuvette sizes or change to an application using different optical filters or a different lamp. During calibration, sensitivity can be further adjusted if desired using the Span function on the keypad.

Once calibrated, the instrument will hold the calibration within instrument specifications (i.e., less than 0.5% electronic drift per month). Unless you change your blank or standard or want to change from reading very high levels to very low levels (or vice versa), you do not have to calibrate every time you read a new batch of samples. (You will, of course, need to recalibrate if you reset the basic operating level, or change the lamp or filters.) **NOTE:** Stable solid secondary standards are available from Turner Designs, which can be used to verify instrument stability.



### 1. Instrument Range and Standard Concentration for Calibration

Examine Figure 2 below (numbers are for example only). Within the linear range--in this case, assume that 500 is the upper limit of the linear range--sample concentration is directly proportional (linear) to fluorescence "units". On the Model 10-AU HIGH range, you can read substances up to 10 times more concentrated than what can be read on the MED range, which in turn reads substances up to 10 times more concentrated than what can be read on the LOW range.

However, "resolution" is 10 times better on the LOW range than the MED range, and 10 times better on the MED range than the HIGH range. You could think of the ranges as three different scales. Take, for example, the HIGH scale. Assume you could weigh as much as 1000 kilograms, but in 1 kilogram units, i.e., you could weigh something as 751 or 752, but not 751.3, etc. On the MED scale, you could weigh up to 100 kilograms, but on this scale you could read in 0.1 increments. On the LOW scale, you could weigh a maximum of 10 kilograms, but in 0.01 kilogram increments.

#### **Choosing a standard concentration and instrument range:**

The instrument will select the appropriate range for running your standard. Follow the step-by-step procedure in the Calibration Instructions, p. 14.

High Concentrations. If you want better accuracy in reading high concentrations, you should choose a standard closer to the upper end of the line graph in Figure 2--a concentration approximately 80% of the upper linear range would work best.

Low Concentrations. In contrast, if you are more interested in low concentrations, a standard concentration toward the low end of the line graph would be preferred.

Broad Range of Concentrations. If you wish to be able to read both high and low concentrations, while making the most of instrument capabilities, choose a standard concentration that can be read on the MED range--i.e., 50-80% of full scale on MED.

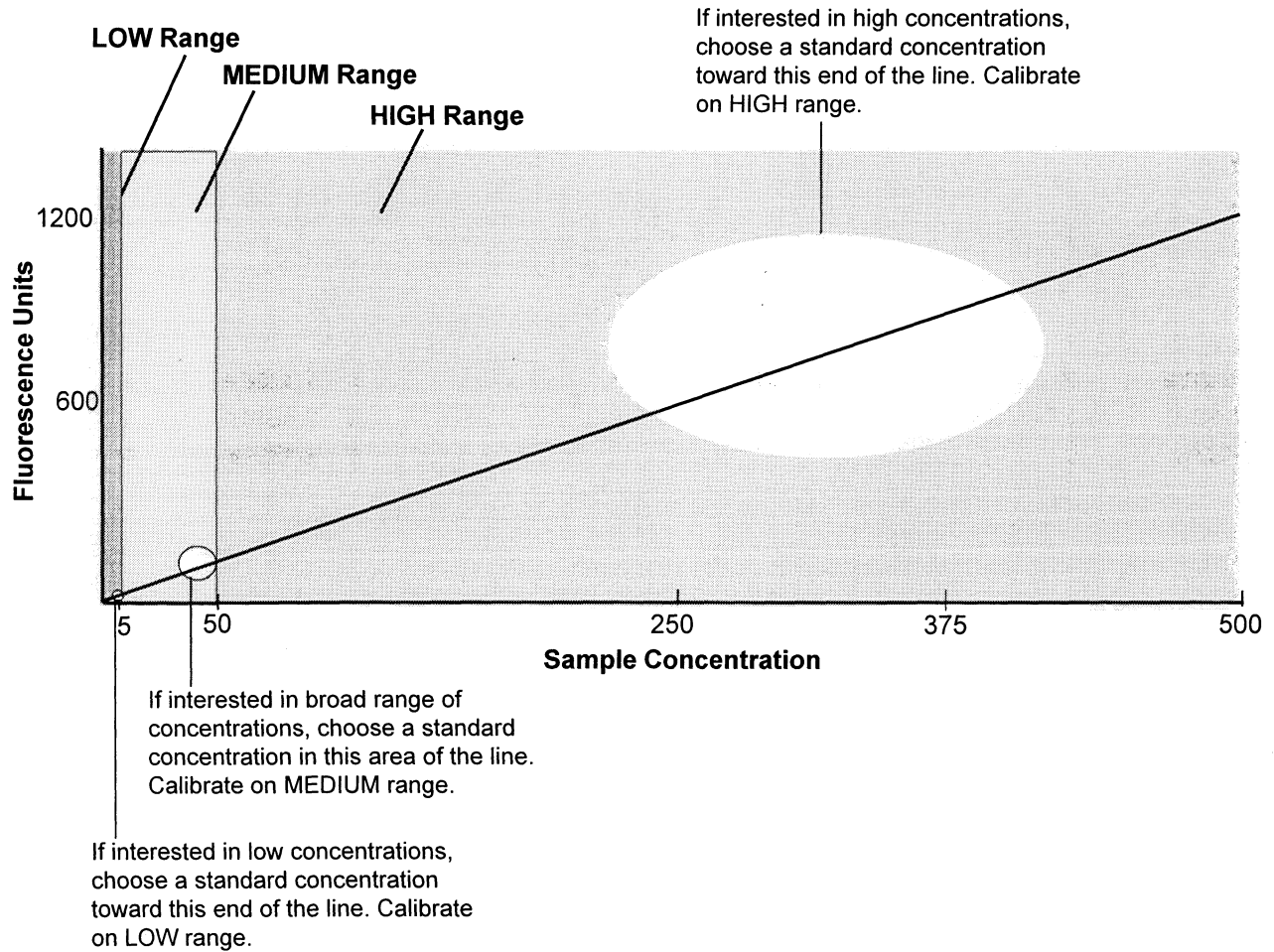

**Figure 2. Instrument Range and Standard Concentration**

(Sample Concentration and Fluorescence Units are for example only. Your units will vary.)

## Section 3 CALIBRATION AND ROUTINE OPERATION

### 2. Recommended Standard Concentration and Instrument Range

The easiest way to calibrate is to let the instrument choose the appropriate range or ranges for running the standard and blank. As stated in the previous section, for the best sensitivity and resolution, you should prepare a standard with a low concentration (running the standard on the LOW range is preferred). If you are dealing with high concentrations, prepare a high concentration standard (running the standard on the HIGH range is preferred). If you calibration on the MED range, the instrument provides a good combination of resolution and the ability to read higher concentrations.

For example, if you want to read samples less than 3 ppb, you will get better accuracy and resolution calibrating with a 2-5 ppb standard (preferably on the LOW or MED range) than with a 75 ppb standard. However, researchers have reported good results reading low samples with the Model 10-AU Fluorometer, even after calibrating with a high standard. (The fluorometer provides good range-to-range correlation.)

**Remember:** The instrument is very forgiving and flexible; in most cases good measurements will be obtained regardless of the range selected for calibration. **Note:** In all cases, for accurate readings the standard **must be** within the linear range for your substance.

It is not possible to provide an exhaustive list of recommended standard concentrations to use. However, for commonly measured substances such as chlorophyll *a* and Rhodamine WT, information about the linear range is helpful. **NOTE:** These are general and conservative guidelines only; results will vary from instrument to instrument, by optical kits, and by cuvette diameter. Linearity can be determined by a simple ratio measurement (see Appendix 6A).

	Linear Range	Range for Calibration Curve
Rhodamine WT <sup>1</sup>	100 ppb (500 ppb as 100% tracer)	500 ppb (2,500 ppb as 100%)
Chlorophyll a <sup>2</sup>	250 µg/L (ppb)	---

- 1 Rhodamine WT comes as an aqueous solution of approximately 20% active ingredient. The above concentrations assume dilutions were made considering the dye as active ingredient.
- 2 According to U.S.E.P.A. Method 445.0, using the Turner Designs Model 10 analog Fluorometer (13 mm tubes), chlorophyll *a* is linear to approximately 250 µg/L. (EPA research reports a higher linear range using the 10-AU.)

**3. CALIBRATION INSTRUCTIONS:**

Procedure	Notes & Instructions
1. Turn on the fluorometer and allow it to warm up for 10 minutes.	
2. Prepare a Standard that is approximately 80% of the highest concentration you want to read, but <b>still within</b> the linear range.	See the discussion of broad range, low, and high concentrations above; and Section 3D, screen 2.3.
3. Have on hand your Blank solution.	See the discussion in Section 3C, screen 2.11; and Section 3E3 on high blank.
4. Have on hand the samples you wish to read, with any preparation already completed.	
5. Access the Calibration menu, screen 2.0.	From the HOME screen, press <ENT> for the Main Menu, then <2> for screen 2.0.
6. Set the concentration range control to AUTO.	From screen 2.0, press <4> to bring up screen 2.4, then <3> to bring up screen 2.43 (set conc. control range), and press <ENT> to toggle.
7. Enter the <u>actual concentration</u> for your standard. I.e., 45, 100, 500, etc. (This number must be less than 1000.)	From screen 2.0, press <2> to access screen 2.2 (standard solution value).  If you are reading raw fluorescence (set on screen 1.21), then set the standard solution concentration on screen 2.2 to .1, 1, or 10, with 1 preferred. The purpose of this is to allow you to read the Screen 2.3 table as a simple ratio of 10.
8. If you want the instrument to subtract Blank, make sure screen 2.12 is set to YES.	From screen 2.0, press <1> to access screen 2.1, and make sure subtract blank on screen 2.12 is set to "YES".  See definition under Section 3C, screen 2.11.

### Section 3 CALIBRATION AND ROUTINE OPERATION

Procedure	Notes & Instructions
<p>9A. <b>RUN BLANK:</b> Determine range to run blank.</p>	<p>Press &lt;HOME&gt;. <b>While on the HOME screen</b>, insert your Blank (insert a clean, dry on the outside, cuvette containing your blank). Replace the light cap if running discrete samples. <b>WAIT</b> about 10 seconds while the instrument determines the correct range. (Lower range is preferred.)</p>
<p>9B. Access Run Blank screen 2.11.</p>	<p>Then, access screen 2.11 by pressing &lt;ENT&gt;, &lt;2&gt;, &lt;1&gt;, and &lt;1&gt;.</p> <p><b>IF YOU WISH TO ABORT</b> this procedure and revert to the former calibration settings, then press &lt;ESC&gt; <u>before</u> pressing &lt;0&gt;. This will retain the current settings for the Span and Blank.</p>
<p>9C. While on 2.11, wait until the reading is stable. Then, if the Blank% (in the center of the screen) is less than 200%, <b>press &lt;0&gt;</b>. If not, reduce the Span by pressing the down arrow until the Blank% is less than 200%. Wait for stable reading, then <b>press &lt;0&gt; to accept the value.</b></p>	<p>If Blank readings are very high, verify that your Blank is not contaminated. Refer to section E3 above for an alternate method for high Blank. Consider readjusting the basic operating level (Appendix 6B).</p>
<p>9D. Remove the cuvette and set aside.</p>	
<p>10A. <b>RUN STANDARD:</b> Determine range to run standard.</p>	<p>Press &lt;HOME&gt;. <b>While on the HOME screen</b>, insert your Standard (insert a clean, dry on the outside, cuvette containing your Standard). Replace the light cap if running discrete samples. <b>WAIT</b> about 10 seconds while the instrument determines the correct range.</p>

Procedure	Notes & Instructions
10B. Access Run Standard Screen 2.3.	<p>From HOME, press &lt;ENT&gt;, &lt;2&gt;, and &lt;3&gt;.</p> <p>Pressing &lt;ESC&gt; <u>before</u> pressing &lt;*&gt;, <b>WILL ABORT</b> the standard run and retain the current settings for the Standard.</p>
10C. To Run Standard, wait until the readings are stable (TC cycles from 1 to 8 seconds when arrows are pressed), then <b>press &lt;*&gt; to accept the values.</b>	<p>Though it is not necessary, you may adjust the Span using the up and down arrows until the FS table readings for the ranges are satisfactory.</p> <p><b>NOTE:</b> Changing the Span on this screen will also affect the Blank % as set on screen 2.11; it is <u>not</u> necessary to re-run Blank.</p> <p>Remember, FS is the <u>maximum concentration</u> or relative fluorescence you will be able to read on a particular range, and it is not necessary or likely that FS match the "value" of the standard.</p>
10D. Notes about Run Standard Screen 2.3	<p><b>RAW DATA.</b> If you are interested in raw fluorescence data, the table readings will indicate the maximum relative fluorescence you can read on each range. I.e., if you entered "1" in step 2 and the reading is 9 on the MED range, you can read a sample 9 times as concentrated as your standard. <b>NOTE</b> that the recommendations of when to go to a different calibration method apply here as well.</p> <p><b>BLK&gt;FS.</b> This indicates that the blank is higher than full scale at this range. This is acceptable if blank is high and you want to read high concentrations, <u>if</u> the FS on the higher ranges is acceptable.</p> <p><b>OVER.</b> If you calibrate in manual vs. autorange, it is possible that the FS will read OVER. If the FS reads OVER, with the Span close to 0%, it means that the standard concentration is too high for the range you are in. If you are in the LOW range, change to the MED range; if you are in the MED range, change to the HIGH range. To change ranges, &lt;ESC&gt; from screen 2.3. Then, from screen 2.0, press &lt;4&gt;, &lt;2&gt;, and use &lt;ENT&gt; to toggle to the desired range. Then, run step 10.</p>

**Section 3 CALIBRATION AND ROUTINE OPERATION**

Procedure	Notes & Instructions
10D. Notes about Run Standard Screen 2.3 (continued)	<p><b>OVER on the HIGH range.</b> If you are in the HIGH range and FS reads OVER, with the Span close to 0%, it means the concentration exceeds the maximum limit of detectability for the instrument. Reset the basic operating level (Appendix 6B); consider changing reference filters, or to a smaller cuvette size, or adding an attenuator plate. (See the discussion on decreasing sensitivity in Appendix 6A.)</p>
	<p><b>&gt;9999.</b> If FS reading exceeds 9999.999, the maximum allowable for the table, the reading will display "&gt;9999". To get an on-scale reading, press &lt;ESC&gt; and reduce the standard solution concentration on screen 2.2 by a factor of 10. I.e., if it was 500, set it to 50, or 5 if necessary. If you do this, make note of the factor, as all of your samples will have to be multiplied by this factor to determine the actual concentration. Then, repeat step 10.</p>
	<p><b>Span equals 99% in the LOW range.</b> If the Span is 99% and the reading for the LOW range is greater than 10 times the standard solution as set on screen 2.2, it probably means you will not be able to detect concentrations much less concentrated than your standard. (See discussion on increasing sensitivity in Appendix 6A.)</p>
11. Return to HOME screen.	Press <HOME>. Run samples.

## **G. Routine Operation**

Once the instrument is calibrated, simply insert a cuvette containing your sample into the Sample Compartment (replace the Light Cap) or start sample flowing through the flow cell, and read the concentration or raw (relative) fluorescence data on the HOME screen.

Note that the HOME screen can accommodate only three digits (XXX; XX.X; X.XX; .XXX) for sample readout. The instrument, however, can support 7 digits (XXXX.XXX) for each range. Sample readings on the HOME screen will be rounded-off to 3 digits, and a reading greater than 999 will flash ">999". Refer to Display flashes >999 in subsection 2 below if you desire more than three significant digits or are reading samples greater than 999.

The table showing the full scale available for each range as set during the last calibration can be accessed directly from the HOME screen by pressing the left arrow.

1. Auto-ranging. Setting the instrument to perform auto-ranging will give you the best possible resolution on sample readings without having to manually change ranges. (See the discussion of Auto-ranging in Section 3B1.)

To activate auto-ranging, access screen 2.43, and set to AUTO. Refer to "Manual Operation," following, for a discussion of the meaning of "OVER," >999, or a minus (-) sign before the readout.

2. Manual Operation. If you choose to operate in the manual mode, you will have to change ranges yourself when concentrations are too high or too low for the range currently active. If you want the best possible resolution for your reading, especially on low concentrations, read your sample in the lowest range in which you can obtain an on-scale reading.

OVER. In the manual mode, if the readout flashes "OVER," it means the concentration reads higher than full scale for the current range. If, for example, the Model 10-AU is in MED and the reading is "OVER," access screen 2.42 and change to the HIGH range. Return to the HOME screen to view the readout.

If the reading is OVER on the HIGH range, then the concentration exceeds the upper limits of detectability of the Model 10-AU as currently calibrated. You might try diluting the sample 1:1 until you obtain an on-scale reading to get some idea of the concentration. Or, you can reduce the sensitivity of the instrument by recalibrating and reducing the Span level. Or, consider changing to a smaller cuvette size or adding an



### **Section 3 CALIBRATION AND ROUTINE OPERATION**

attenuator plate. (See the discussion on decreasing sensitivity in Appendix 6A.)

Display flashes >999. If the reading exceeds 999, the maximum allowable for the HOME screen, the display will flash ">999". Check the calibration table by pressing the left arrow. If the full scale reading for the current range is less than 9999.999, you can try reading your samples on screen 3.2. (See Appendix 5B, screen 3.2; and see item 4, Data Logging, below.) Or, access screen 2.2 and reduce the standard solution concentration by a factor of 10. I.e., if it was 500, set it to 50, or 5, if necessary to make the full scale reading less than 999. If you do this, make note of the factor, as all of your samples will have to be multiplied by this factor to determine the actual concentration or relative fluorescence.

Minus. If the readout on the HOME screen has a minus sign in front of it, it means that the sample is less concentrated than blank. This is more likely where you have calibrated with high blank. (See Section 3E3 for a suggested procedure for dealing with high blank.)

In cases of high blank, where the calibration table full scale value for a range reads "BLK > FS," which means that blank is higher than full scale on that range, you will not be able to use that range for sample readings.

3. Discrete Sample Averaging. Discrete sample averaging is a very useful feature for ensuring consistent readings on discrete samples, especially with temperature-sensitive samples. It allows you to average the readings over a user-settable period, and freeze the digital display for 10 seconds so you can note the reading. Thus, each sample can be read after the same amount of time has passed; and the averaging and freezing of the display minimizes both the inconvenience and potential error when readings fluctuate. See Appendix 5A, screen 1.63, to set the parameters for discrete sample averaging.
4. Data Logging. To configure the Model 10-AU for data logging using external data collection devices or the optional internal data logger, refer to Appendix 11.

**Note:** You can view and save sample readings to 7 significant digits by exporting the serial data output to a computer.

## **Model 10-AU-005-CE Fluorometer User's Manual**

5. Sensitivity Setting Retrieval. For long term studies, or where you would like to repeat a study with precision, it can be useful to be able to return to a previous instrument sensitivity setting. The diagnostic screens of the Model 10-AU make it possible to return to a former sensitivity setting simply by matching three previously noted readings.

NOTE: In order to retrieve a setting, you must make a note of three parameters before your study is complete.

Refer to Appendix 6C for step-by-step instructions.

6. Using Raw Data or a Ratio Method. If you are working with raw data and have calibrated with a standard of unknown concentration, you will need to perform ratio calculations to determine the actual concentration of your samples.

Say, for example, you are measuring chlorophyll *in vivo* via continuous flow on board ship. During calibration you called your standard "10" on screen 2.2. Later, the standard concentration is determined by extractive method to be 5 ppb of chlorophyll. If an unknown in the field read 12 as compared to the standard you called "10", the actual concentration of the unknown would be 6 ppb ( $5 \text{ ppb}/10 \times 12$ ).

## Section 4

### ALARMS AND TROUBLESHOOTING

#### A. Alarms

##### 1. Introduction

A variety of alarms have been built into the system to warn about conditions relating to internal instrument functions or low or high sample levels.

There are two basic types: alarms that monitor internal fluorometer functions and warn of possible problems with the instrument itself; and alarms that monitor fluorescence levels and warn of levels outside of user-settable limits. To avoid unnecessary triggering of alarms, the condition must be in effect for a certain delay period.

##### 2. Internal Function Alarms

Table 2 shows the internal function alarms, which are set by Turner Designs and cannot be changed. The status of these parameters can be checked by accessing the diagnostic information in screen 3.1. Refer to Appendix 5B for definitions.

**Table 2. Internal Function Alarms**

<u>Alarm</u>	<u>Delay</u>	<u>Range</u>
Lamp Off/Bad	1 min.	ON, Off/Bad
Chopper Speed Too Slow	2 min.	<500 rpm
Fluorometer Too Hot	5 min.	>90°C
Fluorometer Too Cold	5 min.	<-20°C
Circuit Failure	4 min.	OK, Failure
Low Power Level	1 min.	<10 % (DC: 100% = 12V; 0% = 10.2V)
High Voltage Too High	3 min.	>1000 V
High Voltage Too Low	3 min.	<25 V

3. System Alarms

Table 3 shows the user-settable system alarms. By accessing screen 1.1, the user can choose to have an alarm triggered if the sample either reaches a certain low reading (low level alarm), or a certain high reading (high level alarm). The user can also select the delay time for the alarm. Refer to Appendix 5A, screen 1.1.

<u>Alarm</u>	<u>Delay</u>	<u>Range</u>	<u>Default</u>
Low Level	10-3600 sec.	0.0 - 9998.0	0.0
High Level	10-3600 sec.	1.0 - 9999.9	9999.9

4. Alarm Basics

Alarm triggered. When an alarm is first triggered, or when the condition is first corrected, the fluorometer will beep once from any screen.

When an alarm is activated and when viewing the HOME screen, the fluorometer will beep continuously and "ALARM ON!" will flash in the upper right hand portion of the HOME screen. The beeper will sound twice as fast if an internal fluorometer alarm vs. a system alarm is triggered.

Press <ESC> to view the alarm screen and take the appropriate action to clear the condition (see Troubleshooting, below).

NOTE: The beeper will not sound if you have deactivated it (from screen 1.62).

Clearing an alarm. Press <ESC> or <HOME> to return to the HOME screen from the alarm screen.

When the condition triggering the alarm is cured, the "ALARM ON!" warning will disappear from the HOME screen, and the beeper will stop.

All alarms will be reset automatically if the alarm condition is corrected. To avoid inaccurate readings, alarms cannot be stopped EXCEPT by curing the problem.

## Section 4 ALARMS AND TROUBLESHOOTING

Multiple alarms. If multiple alarms are triggered, the alarm screen will list all the alarms in the order of their occurrence. Keep in mind that the triggering of certain alarms will trigger other alarms, even though there may be nothing wrong. For example:

- a. If the lamp is bad, this condition will trigger the high voltage alarm (after the delay period expires), even if there is nothing wrong with the high voltage other than its relationship to the bad lamp. It will also trigger the circuit failure alarm.
- b. If the chopper wheel is bad, it may also trigger either the high voltage too high or high voltage too low alarms, depending on what position the wheel is in when it stops.
- c. The circuit failure alarm indicates a possible problem with the photomultiplier tube or the pre-amplifier. Depending on the problem, this may trigger either the high voltage too high or high voltage too low alarms.

Therefore, where there are multiple alarms it is IMPORTANT to deal with them in the order in which they appear on the alarm screen.

A typical alarm screen, with one alarm condition looks like this:

```
***** A L A R M *****  
  
Lamp is Off/Bad  
  
                                     <ESC> to HOME screen
```

An alarm screen with multiple alarms might look as follows:

```
***** A L A R M *****  
  
Lamp is Off/Bad  
Chop. Spd Too Slow  
High Volt Too High  
Fluor. Too Cold  
  
                                     <ESC> to HOME screen
```

For information on what to do to correct the condition when an alarm is triggered, refer to the specific alarm condition in the Troubleshooting section, below.

**B. Troubleshooting**

Troubleshooting will probably begin when an alarm is triggered. The table below sets forth what to do when alarms are triggered or various problems occur. In addition to the alarms, there are two diagnostic screens that provide information on various instrument parameters. These screens can aid in identifying the source of a possible malfunction. (App. 5B, screens 3.1 and 3.2.)

To aid in troubleshooting, before contacting the manufacturer, we recommend that you fill out the diagnostic form at the end of this chapter.

<b><u>Symptom</u></b>	<b><u>Correction</u></b>
Lamp Off/Bad Alarm	Check or change lamp (Appendix 8).
Chop. Spd Too Slow Alarm	Contact manufacturer. This alarm could mean a position/speed sensor problem or a bad motor.
Fluorometer Too Hot Alarm	This alarm is triggered if the internal temperature of the fluorometer rises above 90°C (based on internal sensor: accuracy +/- 5°C). Turn off the fluorometer and allow it to cool down. If the fluorometer feels cool and this alarm is active, there could be a temperature sensor problem. Contact Turner Designs.
Fluorometer Too Cold Alarm	This alarm is triggered if the internal fluorometer temperature falls below -20°C (based on internal sensor: accuracy +/- 5°C). Make sure power is on. After start-up in cold conditions, the temperature should rise above the alarm limit within the delay period. If not, it could mean a problem with internal circuitry. Contact Turner Designs.
Circuit Failure Alarm	This alarm is triggered if there is a problem with the photomultiplier tube or the pre-amplifier. It will also be triggered if the lamp fails, or if the high voltage is too high or too low, or if the chopper speed alarm is triggered. If one of these other alarms is activated, check them first. If this does not correct the problem, contact Turner Designs.
High Voltage Too High Alarm	Check that the proper filters are correctly installed, and their condition. See Appendices 8 and 9. This alarm will also be triggered by a lamp failure. It <u>may</u> be triggered by a circuit failure or a chopper motor failure.

## Section 4 ALARMS AND TROUBLESHOOTING

<u>Symptom</u>	<u>Correction</u>
High Voltage Too Low Alarm	Check that the proper filters are correctly installed, and their condition. See Appendices 8 and 9. It <u>may</u> be triggered by a circuit failure or a chopper motor failure.
Low Level Alarm	This is triggered when the sample reads at or below the user-settable concentration limit. (Alarm level is compared with the sample concentration displayed on the HOME screen.) Make sure this alarm is set where you want it, or disable it. See Appendix 5A, screen 1.1. If using the continuous-flow cuvette, check the sample delivery system (lines, connections, pump) and the flow cell for leaks (see Appendix 7).
High Level Alarm	This is triggered when the sample reads at or above the user-settable concentration. (Alarm level is compared with the sample concentration displayed on the HOME screen.) Make sure this alarm is set where you want it, or disable it. See Appendix 5A, screen 1.1. If using the continuous-flow cuvette, check the sample delivery system (lines, connections, pump) and the flow cell for leaks (Appendix 7).
Low Power Alarm	This alarm is triggered if the power level drops below 10%. Check power source (battery level if operating on DC power.)
Erratic/Noisy Readings	(No alarms activated.) Check calibration (see Section 3F). Check for air bubbles in the sample (see Appendix 6A). Check the flow cell and clean if necessary (see Appendix 7).
Unstable/Drifting Readings	(No alarms activated.) Check the reference filter (see Appendix 8). Check for moisture on the outside of the cuvette. On continuous-flow, check sample delivery system (lines, connections, pump) and flow cell for leaks (see Appendix 7).
Low Readings	(No alarms activated.) Check fluorometer concentration range. (Displayed on HOME screen, or see screen 2.4, item 2). Check calibration (see Section 3F). Check filter selection and placement (see Appendices 8 & 9). Check flow cell, and clean if necessary (see Appendix 7).

**Symptom**

**Correction**

High Readings

(No alarms activated.) If using the cuvette adapter, is the Light Cap on? Check fluorometer concentration range (HOME screen, or see screen 2.4, item 2). Check calibration (see Section 3F). Check filter selection and placement (see Appendices 8 and 9). Check flow cell for leaks (see Appendix 7).

No Response

Make sure power is on. Check power source. If using DC power, check fuse on fluorometer.

Blank or dark screen

If power is on and screen is blank or dark, try adjusting the screen contrast using the <UP> or <DOWN> arrow.

NVRAM Warning Screen

Refer to complete instructions, at the end of this section. After the fluorometer has been in use for several years, a warning screen will be automatically displayed when the instrument is turned on, which informs the user of problems with the NVRAM. This screen displays: "WARNING! NEW NVRAM, <1> to set default." This message indicates that the NVRAM internal battery may be low. The instrument will still operate, but once the battery fails, every time it is turned off it will not retain instrument settings and previous calibration settings unless power is continuously supplied to the instrument. **Temporary Solution:** The problem can be mitigated simply by leaving the instrument ON at all times, until the NVRAM module can be changed. If it is turned off, instrument settings will have to be reset and the instrument recalibrated.

**Note:** When the NVRAM fails, any data stored in the internal data logger **will be saved**, as it is not dependent on the NVRAM.

**Note:** On rare occasions, you may see "Some NVRAM DATA are corrupted, <1> to restore default, <0> to continue." This may indicate that there is some problem with the memory chip for storage of instrument settings. Press <1> and this may temporarily allow you to obtain readings. If readings or software performance is not normal, contact the manufacturer. Replace the NVRAM.



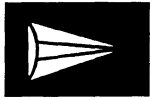

## Replacing the NVRAM Memory Chip

**BACKGROUND.** Each fluorometer contains one or two memory chips with embedded batteries. One chip, the NVRAM (non-volatile data), stores various instrument parameters such as calibration values. Some fluorometers contain a second chip, the IDL Module, which stores internal data logging values (if this option was ordered when your fluorometer was purchased). Both of these batteries will be depleted after some years use. The battery has a 10-year life specification.

**NVRAM.** After the fluorometer has been in use for several years, a warning screen will automatically be displayed when the instrument is turned on, which informs the user of problems with the NVRAM. This screen displays: "WARNING! NEW NVRAM, <1> to set default." This message indicates that the NVRAM internal battery is low. The instrument will still operate, but once this message appears, every time the fluorometer is turned off it will lose instrument settings and previous calibration settings.

**Temporary Solution:** The problem can be mitigated simply by leaving the instrument ON at all times, until the NVRAM module can be changed. If it is turned off, instrument settings will have to be reset and the instrument recalibrated. It is recommended that you write down your parameter settings immediately, in case the fluorometer is inadvertently turned off.

**Note:** When the NVRAM fails, any data stored in the internal data logger **will be saved**, as it is not dependent on the NVRAM.

**Note:** On rare occasions, you may see "Some NVRAM DATA are corrupted, <1> to restore default, <0> to continue." This may indicate that there is some problem with the memory chip for storage of instrument settings. Press <1> and this may temporarily allow you to obtain readings. If readings or software performance is not normal, contact the manufacturer and we may be able to temporarily mitigate the problem. If this screen appears, however, you should replace the NVRAM. If it appears again after a new NVRAM is installed, contact the manufacturer.

**IDL MODULE.** If your instrument is equipped with the Internal Data Logging option, you will need to replace the IDL module when the battery for internal data logging fails. When it fails, the menu for the Internal Data Logger will disappear from the screen, i.e., item #5 "Internal Data Logger," will not appear on the MAIN MENU; or every time the instrument is repowered, the internal data logger will appear as a new (blank) data logger. **WARNING:** When the data logger battery fails, any data logged which has not been downloaded will be lost. Download more frequently after the instrument has been in use for several years, to avoid loss of logged data. Replace the IDL module as the 10-year life specification of the battery approaches. Contact Turner Designs for instructions.

### **IMPORTANT PRECAUTIONS**

**WARNING!!** High voltage up to 1000 volts may be present inside the instrument. Use caution and avoid the area around the large orange capacitors and lamp transformer (300 V) on the Power PCB (PCB at front of the instrument, right hand side as you face the front of the unit). Stored voltage will dissipate after a few minutes.

**NOTE:** It is important to follow disassembly and reassembly instructions carefully to avoid damage to internal components and impairment of instrument function.

### **NOTES ON CHIP HANDLING:**

- Do not touch the metal pins on the chip without discharging static electricity from your hands. To discharge, touch the metal instrument chassis or handle **BEFORE** touching the chip.
- Chip should be stored in a clean, dry place, free of electromagnetic sources.
- Installation in the wrong orientation will damage the chip and cause a malfunction.
- Bent or improperly seated pins will cause a malfunction.

## NVRAM INSTALLATION

1. If the NVRAM has not failed yet and the parameters are still set, go through each screen and write down the parameters that are currently set (so resetting parameters after installation will be easier).
2. UNPLUG THE INSTRUMENT!!!
3. Remove the fluorometer from the case:
  - a) Set the instrument on a clean, dry bench or table, front panel up (facing the ceiling).
  - b) Remove the 18 hex-head screws on the perimeter of the front panel.
  - c) Grasp the handles on the front panel of the instrument and lift it straight up. It is helpful if someone holds the case while another person lifts the unit out. **NOTE:** Make sure no wiring is caught before final removal from the case. Be careful not to damage the rubber gasket on the inside perimeter of the case.
  - d) Set the instrument carefully on the bench, top side up, with the front of the unit facing toward you.
4. Face the front of the instrument. At your right, toward the back of the instrument is a corner bracket. Locate the rear-most printed circuit board (PCB). Close to the place where the corner bracket meets the rear panel there is an NVRAM in position U22 (see PCB diagram).
5. Take a small screwdriver and GENTLY pry the NVRAM from its socket. Set aside.
6. Discharge static electricity by touching the chassis. Locate the small dot on the new NVRAM. The new NVRAM must be installed with the dot at the lower left-hand corner as you face the front of the instrument.

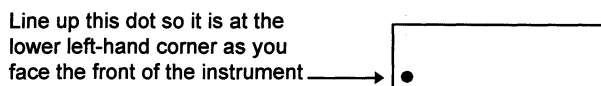

7. To install the new NVRAM into the empty socket:
  - a) Examine the NVRAM before installing to make sure all pins are straight.
  - b) Carefully line up the bottom row of pins with the bottom row of openings.
  - c) Then gently press the top row of pins into the socket.
  - d) When you are sure all pins are properly seated, use the flat side of a screwdriver to press the NVRAM evenly all around, making sure it is in as far as it will go.
8. Make a visual check of the inside components to make sure no wiring is hung up and that everything appears to be secure: cable connections tight; IC's snug, etc.
9. Set the instrument case on its back and grasping the instrument handles, carefully slide the instrument back into the case. Check the rubber gasket on the case perimeter to make sure it is properly seated and undamaged.
10. Before reinstalling the 18 hex-head screws, plug in the unit and turn it on. A screen will appear announcing a new NVRAM. Press <1> and access the Main Menu and check for normal operation by paging through screens, etc. Turn the instrument off, then on again to make sure no NVRAM warning screen appears again. If a warning screen reappears, recheck your installation of the NVRAM.
11. Check the 18 hex-head screws to make sure the o-rings underneath the screw heads are present and undamaged. Reinstall the 18 hex-head screws and tighten snugly, but DO NOT overtighten and strip the nuts.
12. Reset instrument parameters and calibrate.
13. Write down the date of installation on the label supplied and affix it to the instrument.

**TURNER DESIGNS**

845 W. Maude Avenue • Sunnyvale, CA 94086  
(408) 749-0994 • FAX (408) 749-0998  
Internet: <http://www.turnerdesigns.com>

---

Please send the following information to assist us in evaluating your instrument operation:

Client: \_\_\_\_\_ Contact: \_\_\_\_\_

Telephone: \_\_\_\_\_ FAX: \_\_\_\_\_

Instrument Serial No. \_\_\_\_\_ RMA # \_\_\_\_\_

Information about your standard:

Identification: \_\_\_\_\_

Concentration: \_\_\_\_\_

Lamp Part No.: \_\_\_\_\_

Excitation filter PN: \_\_\_\_\_

Reference filter PN: \_\_\_\_\_

Emission Filter PN: \_\_\_\_\_

Cuvette Size: 25mm 13mm 10X10 none

Type of flow cell: \_\_\_\_\_

After calibrating the instrument, leave the calibration standard in the sample holder and access the diagnostic screens 3.1 and 3.2. Document the following:

Power level: \_\_\_\_\_

Instrument Temp.: \_\_\_\_\_

Chopper RPM: \_\_\_\_\_

Lamp: \_\_\_\_\_

High Volt: \_\_\_\_\_

CKT Status: \_\_\_\_\_

Fluorescence Readout: \_\_\_\_\_

PM Signal: \_\_\_\_\_

Cal std val: \_\_\_\_\_

Blank: \_\_\_\_\_

FS: \_\_\_\_\_% of \_\_\_\_\_ at \_\_\_\_\_

List any alarms (press <ESC> from HOME screen to view active alarms):

Span level%: \_\_\_\_\_

Symptoms (be specific):

**PAGE INTENTIONALLY BLANK**

## Section 5

### MAINTENANCE, WARRANTY, & SERVICE

#### A. Maintenance

To keep your Model 10-AU Fluorometer in good operating condition, the following maintenance procedures should be performed on a routine basis:

1. Clean off corrosive materials, including saltwater.
2. Check the flow cell system to make sure it is clean and that there is no evidence of leaks. (See Appendix 7.) Periodically check inside the Sample Compartment for evidence of moisture.
3. In humid areas, desiccant should be installed in the Sample Compartment area if the Continuous-flow Cuvette System is used. (See Appendix 7.) There is not much point in using desiccant with the Discrete Sample Cuvette Holder. The only way to avoid condensate with this is to have the samples at a temperature above dewpoint.
4. After some years use, the NVRAM chip for storage of calibration values and various instrument parameters will have to be replaced. See Section 4, Alarms & Troubleshooting, for details.
5. Before storing your fluorometer, remove the Sample Compartment cover and make sure the Sample Compartment is dry and free of corrosive materials (including salt). Add fresh desiccant. When you bring the fluorometer from storage, be sure to add fresh desiccant. If using a cuvette holder, tape the Light Cap securely over the opening in the top of the Sample Compartment.

#### B. Warranty

Turner Designs warrants the Model 10-AU series fluorometers and accessories to be free from defects in materials and workmanship under normal use and service for a period of one year from the time of initial purchase, with the following restrictions:

1. The instrument and accessories must be installed, powered, and operated in compliance with the directions in this Model 10-AU-005-CE Fluorometer User's Manual and directions accompanying the accessories.
2. Damage incurred in shipping is not covered.
3. Damage resulting from measurement of samples found to be incompatible with the materials used in the sample system is not covered.

## **Model 10-AU-005-CE Fluorometer User's Manual**

4. Damage resulting from contact with corrosive materials or atmosphere is not covered.
5. Damage from sea water and other moderately corrosive materials that are not promptly removed from the instrument is not covered.
6. Damage caused by modification of the instrument by the customer is not covered.
7. The backlight on the digital display is warranted for 1800 hours of operation.

### **C. Obtaining Service**

#### **1. Warranty Service**

To obtain service during the warranty period, the owner shall take the following steps:

- a. Write or call the Turner Designs service department and describe as precisely as possible the nature of the problem.
- b. Carry out minor adjustments or tests as suggested by the Service Department.
- c. If proper performance is not obtained, ship the instrument, prepaid, to Turner Designs, with a statement of shipping charges. The instrument will be repaired and returned free of charge, along with a check to cover shipping charges to us, for all customers in the contiguous continental United States.

For customers outside of the contiguous continental United States, and who have purchased our equipment from our distributors, contact your distributor. If you have purchased direct, contact us. We will repair at no charge, but will not pay for shipment, documentation, etc. These charges will be billed at cost.

**NOTE!** Under no conditions should the instrument or accessory be returned without notice. Prior correspondence is needed:

1. To ensure that the problem is not a simple one, easily handled in your laboratory, with savings to everyone.
2. To specifically determine the nature of the problem, so that repair can be rapid, with particular attention paid to the defect you have noted.

## **Section 5 MAINTENANCE, WARRANTY, & SERVICE**

### 2. Out-of-Warranty Service

Proceed exactly as for Warranty Service, above. If our service department can assist you by phone or correspondence, we will be glad to, at no charge.

Repair service will be billed on a basis of time and materials. A complete statement of time spent and materials used will be supplied. Shipment to Turner Designs should be prepaid. Your bill will include return shipment freight charges.

**(THIS PAGE INTENTIONALLY BLANK)**



## Appendix 1 OPERATING CONDITIONS

### A. Power Requirements

(See Appendix 11H for Power/Telemetry Connector pin inputs and outputs.)



**115 VAC.** Standard power is 115 VAC, unless 230 VAC or DC is specified. The power cable has a screw-on connector for attachment to the fluorometer and 3-prong plug for connection to the AC power source.

The operating range is 100 to 130 V, 50 to 60 Hz. Virtually any generator, as well as normal household current, will supply power. The instrument is protected against transient spikes, and prolonged operation (several minutes) at 140 volts will cause no damage. AC current drain is about 0.8 amps.

The power cable is wired for use with analog and serial data collection devices. If you want to use a computer, chart recorder, or data logger, see Appendix 11A.

**230 VAC** is available upon request. Analogous to 115 volts, the operating range is 200 to 250 volts, 50 to 60 Hz. Current drain is about 0.4 amps.

**DC Power.** The 10-AU-005-CE can also be configured for 12 VDC through an optional DC power cable.

The DC operating range is 11 to 16 volts. Typical current drain is about 2.5 amperes, independent of voltage.



**If using DC power and a battery**, please note that the DC Power Cable with alligator clips is for portable and temporary connection only; it is **NOT** for permanent connection or marine use. For permanent connection or marine use, use the Marine Battery Cable only.

**Changing Power Source.** All instruments, except for certain ones manufactured for use within another system, will operate on DC as well as AC power. However, the AC power cables will not function on DC power, and vice versa.



The negative DC power line is grounded to the instrument case. Preferably, the instrument and all telemetry outputs should be isolated from the DC source. If this is not possible, ground to the negative side of the DC power source only.

**B. Environmental Considerations**

The 10-AU-005-CE Fluorometer is a durable field instrument designed to operate under a wide variety of environmental conditions.

**Temperature.** Storage temperature is  $-20^{\circ}\text{C}$  to  $+60^{\circ}\text{C}$ . The minimum operating temperature is  $5^{\circ}\text{C}$ ; the maximum is  $40^{\circ}\text{C}$  ambient.

**NOTE:** **Water and Dirt.** Your fluorometer will arrive in a laboratory or a field case. Both cases are sealed to prevent water from reaching the electronics. In the field case, with the continuous-flow cuvette installed, the fluorometer will withstand waves, rain, and splashing, and can be washed off with water. The unit is not designed for submersion.

The inside of the Sample Compartment should be kept clean and dry. (See Appendix 7 for what to do if there is a spill.)

**Movement or Vibration.** The instrument can be moved and will not be affected by moderate vibration. The instrument is designed to operate in moving vehicles. It is important, however, to fasten it securely to prevent it from colliding with other hard objects.

**CAUTION**

**Helium.** If you are working with exotic breathing mixtures, or other systems using helium, keep them away from the fluorometer because they can cause damage to the photomultiplier.

**Altitude Specification:** 0 - 2000 m.

**Transient Overvoltages:** According to Installation Category II.

**Pollution Degree 2** in accordance with IEC 664.

**C. Mounting Considerations**

Mounting Position. For maximum stability and proper cooling of the light source, the average position of the instrument should be within 20 degrees of level.

Watch overall temperature rise in enclosed racks. Heat may be caused by other equipment. Temperatures should be kept low and constant.

Access Requirements. During normal operation, only access to the front panel controls is needed. Be sure to allow enough room for cleaning the flow cell or for easy cuvette insertion.

**D. Sample System**

Your Model 10-AU-005 Fluorometer is equipped with the 25 mm Continuous-Flow Cuvette System unless you requested another configuration.

You can change to the 13 mm or the 3 mm flow cells if you want to read higher concentrations, or to a cuvette holder for discrete sample measurements. The 13 mm & 25 mm Discrete Sample Cuvette Holder allows rapid change of cuvette sizes.

See Appendix 7 for more information about sizes available, and Appendix 10 for a discussion of the sensitivity of the various cuvettes and flow cells. Refer to the Model 10-AU Digital Fluorometer Ordering Information booklet for specifications.

If you wish to use one of the other cuvettes or flow cells, install it according to the instructions accompanying it, or see Appendix 7.

**E. Model 10-AU-005-CE Fluorometer Specifications**

<u>Alarm:</u>	User-enabled audio and visual alarm when fluorescence of sample falls below or exceeds user-settable limits.
	Alarm delay time: 10 - 3600 seconds
<u>Analog Output:</u>	User-settable analog output, full-scale voltage: 0.1, 1, 2, or 5 volts.
<u>Auto-Ranging:</u>	User-settable to manual or to automatic range-changing in response to changing concentration levels.
<u>Blanking:</u>	Up to 200% of signal full scale on all ranges.
<u>Continuous-Flow Cuvettes:</u>	Leak resistant cuvettes available in quartz with pathlengths of 3 mm, 10 mm, and 25 mm. Three-piece flow cells are available in pathlengths of 10 mm and 25 mm.

## **Model 10-AU-005-CE Fluorometer User's Manual**

<u>Digital Display:</u>	<p>Displays: fluorescence readout, time, date, and directions to Help screen; during internal data logging or in an alarm condition, notice is flashed.</p> <p>At user's option, displays: units of measurement for sample, time constant for signal averaging, concentration range, manual or auto-ranging mode, sample temperature (if equipped with temperature-compensation), and an analog bar graph.</p>
<u>Digital Output:</u>	<p>In ASCII format; through an optional RS-232 serial port.</p> <p>User-selectable baud rate: 4800 or 9600.</p> <p>User-settable, data-logging interval: 1 to 3600 seconds.</p> <p>Outputs are: Raw fluorescence signal units or sample concentration, date, time, index number, and temperature if fluorometer is equipped with temperature-compensation package.</p>
<u>Discrete Sample Cuvettes:</u>	<p>13 mm &amp; 25 mm Discrete Sample Holder, which allows cuvette change in seconds. Custom adapters available upon request.</p>
<u>Discrete Sample Averaging:</u>	<p>By pressing a single key, a sample reading may be averaged over a user-settable time period for simple, accurate measurements.</p> <p>Pre-averaging delay: 1 - 60 seconds Averaging period: 2 - 60 seconds</p>
<u>Electronic Drift:</u>	<p>Less than 0.5% per month.</p>
<u>Excitation Lamp:</u>	<p>4-watt mercury lamp in a variety of wavelength options.</p>

## Appendix 1 OPERATING CONDITIONS

Internal Data Logging: Purchase of internal data-logging package is optional. Instrument will log up to 64,800 data points, including index, time and date, sample readout, temperature (if equipped with temperature compensation).

Data-logging interval: 1, 2, 3, 5, 10, 20, or 30 seconds; or 1, 2, 3, 5, 10, 20 or 30 minutes.

Logging time: 5 hours to 1350 days (depending on data-logging parameters user sets)

Electronic Chart Recording: optional with internal data logging. Allows viewing and downloading a single screen of data from the internal data logger.

Limits of detectability: 10 parts per trillion of Rhodamine WT in potable water.

10 parts per trillion chlorophyll a.

10 ppb of crude oil in water.

Operating Temperature: Minimum: 5°C.  
Maximum: +40°C ambient.

Storage Temperature: -20 to +60°C.

Physical: Dimensions and weight vary with instrument configuration. Range:

	<u>Minimum</u>	<u>Maximum</u>
Size (in.)	21.6 x 18 x 7.7	21.8 x 19.8 x 8.75
Weight (lbs.)	24	34.5

Power, AC: 115 VAC, 230 VAC (+/-10% of the nominal voltage), 50-60 Hz.

Power, DC: 11-16 VDC; 2.5 amperes.

Ranges: Three ranges, each a factor of 10 more sensitive than the next, covering 0 - 9999.999 fluorescence signal units.

## ***Model 10-AU-005-CE Fluorometer User's Manual***

<u>Result Calculation:</u>	Can provide direct concentration readout within the linear range for the substance, without the need for user-calculations; or, if preferred, raw fluorescence data.
<u>Security ID:</u>	User-enabled security ID to prevent unauthorized access to instrument parameters.
<u>Self-Diagnostics:</u>	Instrument diagnostic screens indicate: power level, chopper speed, high voltage level, circuit status, operating time, instrument internal temperature, and lamp status. Alarm is given if a malfunction occurs.
<u>Time Constant:</u>	User-settable to average fluorescence signal for 1, 2, 4, or 8 seconds.
<u>Temperature Compensation:</u>	<p>With the optional temperature-compensation package, the instrument can correct the fluorescence output for changes in sample temperature. User may select either Celsius or Fahrenheit degrees, the temperature coefficient (linear or exponential), and the reference temperature.</p> <p>Temperature coefficient (linear): 0 - 15 %/<sup>o</sup>C or F Temperature coefficient (exponential): 0 - 15 /<sup>o</sup>C or F</p> <p>Temperature accuracy: ±0.4<sup>o</sup>F Nonlinearity: ±0.35<sup>o</sup>F (from -50 to 300<sup>o</sup>F)</p>

## Appendix 2 KEY OPERATING PRINCIPLES OF THE MODEL 10-AU

The following explanation is written for Model 10-AU users who are interested in some of the inner workings of the instrument but do not have a laboratory or instrument background. It is not intended to be a thorough course on fluorometry, but rather an explanation that will make you feel more comfortable with the instrument as you use it.

### Fluorescence

The Model 10-AU Fluorometer measures the concentration of various analytes in samples of interest via fluorescence. A fluorescent molecule has the ability to absorb light at one wavelength and almost instantly emit light at a new and longer wavelength.

Light (exciting light) from a light source (the lamp) is passed through a color filter (excitation filter) that transmits light of the chosen wavelength range (color). The light passes through the sample, which emits light proportional to the concentration of the fluorescent material present and proportional to the intensity of the exciting light. (But see Linearity, in Appendix 6A.)

The emitted light goes out in a sphere. That which is headed for the detector (usually at a right angle to the exciting beam) is passed through another optical filter (emission filter). The purpose of the emission filter is to prevent any scattered exciting light from reaching the detector (in this case a photomultiplier tube) and to pass the emitted color that is specific to the analyte of interest.

The photomultiplier tube looks something like a vacuum tube, which you may have seen in communications or laboratory equipment. Like a simple phototube or photodiode, it generates electrons (electric current) in response to photons (light). What is different about a photomultiplier tube, however, is that it contains many stages (in this case, nine), each of which multiplies the electrons coming from the previous stage. Thus the current is multiplied many times before the amplifier in the fluorometer has to take over.

The wavelength of the exciting light that falls on the sample is set by the choice of the light source and the excitation filter. This wavelength is chosen (1) for strong absorption by the material under study, and (2) for minimal absorption by any interfering fluorescent materials that may be present.

The choices of photomultiplier and emission filter are made so that (1) they respond as much as possible to the light emitted by the material under study, (2) they respond as little as possible to the emission of any interfering fluorescent materials which may be present.

## **Model 10-AU-005-CE Fluorometer User's Manual**

Refer to Figure A1 to see the optical system of the Turner Designs Model 10-AU Fluorometer.

### **Stability**

While the process just described is straightforward, it is challenging to provide an instrument that measures sample with great sensitivity and stability under harsh conditions with less than perfect power supplies. The Model 10-AU Fluorometer achieves stability (minimal drift) by recalibrating itself 10 times a second.

When you are in the middle of a measurement and you have difficulty with your power supply or some other environmental condition, you may wonder if this affects the accuracy of your results. In most cases, it does not, because the instrument is constantly recalibrating itself. It does this by continually looking at the light that passes through the flow cell, then looking at a reference light (that comes from the same light source), and then at total darkness. In a sense, it triangulates itself using these three readings to stay at the same electronic reference point.

Since the same light source and detector are involved in both the measurement and reference path, variations in intensity of the lamp and in sensitivity of the detector are automatically compensated for. This is no little feat when you consider that the sensitivity of a nine-stage photomultiplier tube varies with the ninth power of the voltage.

### **Sensitivity**

The Model 10-AU Fluorometer is highly sensitive. It can measure samples with either very low concentrations or very high concentrations of the analyte of interest, without operator recalibration. Again, the photomultiplier tube is at the heart of this process.

An initial adjustment is made to the basic operating level (sensitivity) using the Sensitivity Adjustment Knob (Appendix 6B), and the final adjustments are made on the keypad during calibration. See the Calibration section of the main text for a discussion of concentration ranges and Span adjustment. (Section 3.)

If you are interested in knowing more, consult the references below.

### **Why Is Fluorescence So Sensitive?**

Any compound that can be measured in a fluorometer can also be measured in a colorimeter. After all, the compound has to absorb light in order to fluoresce.

Fluorescence, however, is as much as 10,000 times more sensitive.



## **Appendix 2 KEY OPERATING PRINCIPLES OF THE MODEL 10-AU**

A colorimeter (or spectrophotometer) does not measure absorbed light. It measures the transmitted light and subtracts this from the 100% (blank) transmission to get the absorbed light.

For example, you wish to measure the distance between two marks only 0.01 inch apart. The way the spectrophotometer would do it would be to measure from each of them to the wall across the room. It would then subtract these two measurements to get the desired answer. Thus, relatively small errors (on a percentage basis) would totally invalidate the answer.

The fluorometer, in effect, simply uses a micrometer caliper and directly measures the distance between the marks.

### **Fluorometry References**

1. G. K. Turner, "Measurement of Light From Chemical or Biochemical Reactions," in Bioluminescence and Chemiluminescence: Instruments and Applications, Vol. I, K. Van Dyke, Ed. (CRC Press, Boca Raton, FL, 1985), pp. 43-78.
2. J. R. Lakowicz, Principles of Fluorescence Spectroscopy (Plenum Press, New York & London, 1983).
3. I. B. Berlman, Handbook of Fluorescence Spectra of Aromatic Molecules (Academic Press, New York & London, Second Edition, 1971).

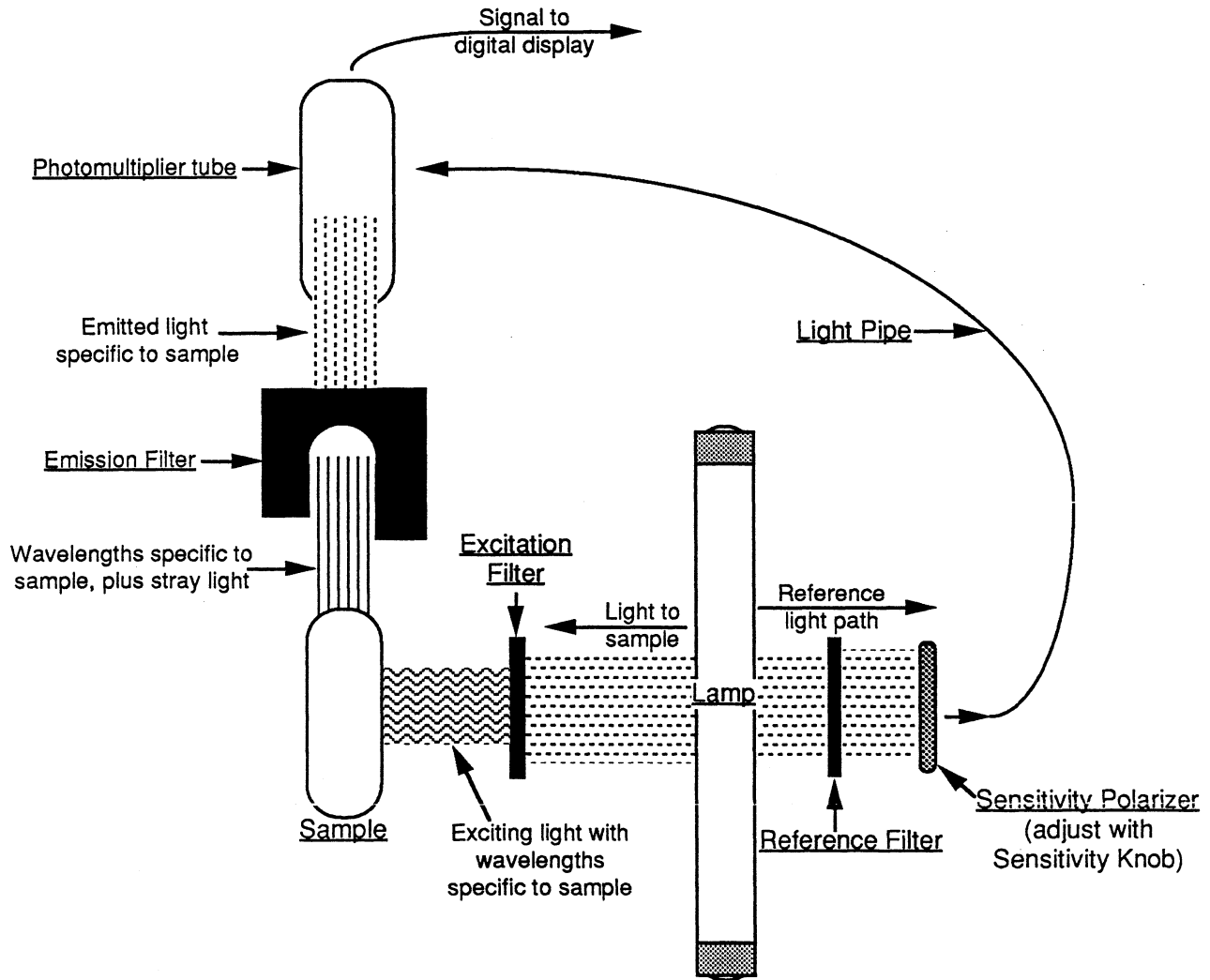

Figure A1. Optical System of the Model 10-AU

### Appendix 3 STUDIES USING THE MODEL 10-AU

The Turner Designs fluorometers have been used for a wide variety of laboratory and field studies. The following are common, but by no means exhaustive, uses for the fluorometer. For information about the limits of detectability using the Model 10-AU, refer to Appendix 10, or ask us for one of our informational monographs. For your convenience, there is an order form for information at the end of this Appendix.

#### A. Chlorophyll and Pheophytin Studies

Fluorometric techniques have many advantages for both qualitative and quantitative measurements of chlorophyll and its primary degradation product, pheophytin. These techniques are relatively simple compared with spectrophotometry, as well as faster and more sensitive.

Lab cultures in 25 x 100 mm test tubes can be read directly in the fluorometer without the disruption of a transfer to another tube.

In many applications, the fluorometer can be used *in vivo*, with the continuous-flow cuvette, eliminating delays for extraction and processing.

The US Environmental Protection Agency has authored a new standard method for extracted chlorophyll. Contact Turner Designs for Method 445.0, "*In Vitro* Determination of Chlorophyll *a* and Pheophytin *a* in Marine and Freshwater Phytoplankton by Fluorescence."

For chlorophyll *a* measurements where chlorophyll *b* is present, another new method, "Fluorometric Analysis of Chlorophyll *a* in the presence of Chlorophyll *b* and Pheopigments," provides a reliable, effective alternative to conventional acidification techniques. (Based on research by Dr. Nicholas A. Welschmeyer of Moss Landing Marine Laboratories, Moss Landing, CA.) Acidification of extracted samples is not necessary; the procedure is sensitive enough for oligotrophic environments; and only a single fluorescence determination is required. Contact Turner Designs for details.

For more information, ask for the monograph, Fluorometric Facts: "Chlorophyll and Pheophytin."

**B. Oil Measurements**

The aromatic fractions of petroleum products are fluorescent. Without extraction, oils and gasoline, and substances such as benzene, toluene, and naphthalene can be measured conveniently with the Model 10-AU. Contact Turner Designs for more information.

Following an oil spill, the aromatic fractions dissolve in the water column and move separately from the unsightly slick on the surface. Since no sample preparation is required, the series 10 fluorometer has become very popular for tracking these fractions, allowing for protective measures for downstream water supplies and shellfish beds. It is also commonly used to map a spill following the use of dispersants. Other uses include performing baseline oil studies; pinpointing oil leaks and natural seeps; and measuring oil in organisms, sediment, and air. For more information, contact Turner Designs.

The 10-AU-005-CE with the continuous flow cuvette and TD-4100 on-line unit have been used to monitor oil in process water and in cooling water.

**C. Flow Measurements and Fluorescent Tracer Studies**

With the continuous-flow cuvette, the series 10 fluorometer has been used extensively with fluorescent dyes, and has proven to be an efficient and cost-effective means of flow measurement and pollution control. It can be used to calibrate flow meters on site; calibrate weirs and flumes in the field, correlate stream-level gauges with the flow rate; measure stream, canal, drainage ditch, and sewer flow directly; study sewer system infiltration; study time-of-travel in streams; and measure residence time in settling basins and disinfection chambers. For more information, ask for the monograph: "A Practical Guide to Flow Measurement."

**D. Process Control**

The Model 10-AU-005-CE can be used for on-line monitoring of industrial processes. It can be operated continuously over extended periods of time with minimal operator supervision.

Ask us about the TD-4100 on-line monitor for hydrocarbons, and the TD-4300 AlgaeMonitor, which are specially configured with alarms and a 4-20 mA signal output for on-line or industrial use.



## TURNER DESIGNS

845 W. Maude Avenue • Sunnyvale, CA 94086

(408) 749-0994 • FAX (408) 749-0998

Internet: <http://www.turnerdesigns.com>

# Free Information from Turner Designs

---

## For more information

Mark the publications of interest, fill in your name and address, and FAX it to Turner Designs at 408/749-0998. Publications will be mailed to you. See the reverse side of this page for more options.

Name
Title
Company
Address
City
State, Zip
Postal Code, Country
Phone
FAX
E-Mail

## Chlorophyll Monographs

- Chlorophyll (Overview of applications) (998-5123)
- An Instrument System for High-Speed Mapping of Chlorophyll *a* and Physico-Chemical Variables in Surface Waters (998-0033)
- Fluorometric Analysis of Chlorophyll *a* in the Presence of Chlorophyll *b* and Pheopigments (998-0051)
- Evaluation of a New Fluorometric Technique that uses Highly Selective Interference Filters for Measuring Chlorophyll (998-0570)
- Chlorophyll and Pheophytin (Bulletin 101) (998-5101)
- Algae Management in Reservoirs and Lakes (Bulletin 105) (998-5105)
- Using the Turner Designs Model 10 Analog, The 10-AU Digital, or the TD-700 Fluorometer with EPA Method 445.0 (998-6000)
- A Procedure for Measuring Extracted Chlorophyll *a* free from the Errors Associated with Chlorophyll *b* and Pheopigments (998-9000)

## Fluorescent Tracer Monographs

- Fluorescent Tracer Studies (Overview of applications) (998-5121)
- A Practical Guide to Flow Measurement (998-5000)
- Using the Turner Designs Model 10-AU Fluorometer to Perform Flow Measurements in Sanitary Sewers by Dye Dilution (998-5001)
- Fluorometry in the Water Pollution Control Plant (998-5102)
- Fluorescein (998-5103)
- Fluorescent Tracer Dyes (998-5104)
- Circulation, Dispersion and Plume Studies (998-5106)
- Flow Measurements in Sanitary Sewers by Dye Dilution (998-5107)
- Preparation of Standards for Dye Studies Using Rhodamine WT (998-5111)

# Free Information from Turner Designs

---

## Hydrocarbon Monographs

- \_\_\_\_\_ TD-4100 Technical Update No. 3 (998-4103)
- \_\_\_\_\_ TD-4100 Technical Update No. 2 (998-4105)
- \_\_\_\_\_ TD-4100 Technical Update No. 1 (998-4106)

## Luminometry Monographs

- \_\_\_\_\_ An Evaluation of the Performance of Ten Commercial Luminometers (998-5212)
- \_\_\_\_\_ ATP Measurements: Theory and Practice (998-5202)
- \_\_\_\_\_ Applications of Beetle Luciferases as Genetic Reporters (998-5209)
- \_\_\_\_\_ Review: Reporter Genes; Application to the Study of Mammalian Gene Transcription (998-5215)

## Application Notes

- \_\_\_\_\_ Application Note: A Method for DNA Analysis (998-2600)
- \_\_\_\_\_ Application Note: A Method for EnzChek™ (998-2601)
- \_\_\_\_\_ Application Note: A Suggested Method for Aflatoxin Analysis (998-2610)
- \_\_\_\_\_ Application Note: A Method for PicoGreen® (998-2630)
- \_\_\_\_\_ Application Note: A Method for NanoOrange™ (998-2650)
- \_\_\_\_\_ Application Note: A Method for Quantitation of Green-Fluorescent Protein (998-2670)
- \_\_\_\_\_ Application Note: A Method for CyQuant™ (998-2672)
- \_\_\_\_\_ Application Note: A Method for RNA (998-2675)
- \_\_\_\_\_ Application Note: A Suggested Method for Histamine (998-7700)

## More Options

Call us at 408/749-0994 or Fax us at 408/749-0998  
Visit our Web Page: <http://www.turnerdesigns.com>

## Appendix 4 ACCESSORIES FOR THE MODEL 10-AU FLUOROMETER

Turner Designs carries accessories for all aspects of the Model 10-AU series fluorometers. Refer to the Turner Designs Model 10-AU Digital Fluorometer Ordering Information booklet at the end of this manual.

### A. Batteries for DC Power

For DC operation, the Model 10-AU Fluorometer will function properly on any portable generator providing 110-130 volts AC at 50-60 Hz, or battery that will provide 11-16 volts DC at 2.5 amperes. The negative lead should be grounded.

For portable applications, a battery is more commonly used. The prime requirement is that it must deliver 2.5 amperes for the period of expected operation without having the voltage drop below 11.

A 12-volt lead-acid battery is probably the best choice for most applications. One example is a battery designed for snowmobiles, with special caps to prevent any battery acid loss. The Gould SN-9L is rated at 32 amp/hours, weighs 21 pounds, and is 7 3/4" x 5 1/4" x 7 1/4". It has a life of about 12.8 hours.

A disadvantage of this battery and all automotive-type batteries is that they are not designed for complete discharge without damage unless they are recharged immediately after each discharge.

A battery designed especially for field work, permitting complete discharge without immediate recharge, is the Globe GC-1220B 20-ampere hour battery. It weighs 16 pounds, and is 7" x 6 1/2" x 5". It has a life of about 8 hours.

### B. Pumps for Continuous-Flow Systems

Normally, sampling using the Model 10-AU 25 mm Continuous-Flow Cuvette System is done with a pump.

Flow Rate. We are frequently asked what flow rate is appropriate for continuous measurement in a flow cell. With two exceptions (discussed below), it does not matter.

Fluorescence typically occurs about ten nanoseconds after the molecule absorbs the exciting light. For a molecule to be excited on entrance to the active zone of the continuous flow attachment, and exit prior to emission, would require a flow rate of approximately 500,000 gallons per minute.

The flow rate to be used, therefore, is at the discretion of the operator. The flow rate will be a compromise between the desire to minimize transit time and the pump power and size available. The maximum flow rate that will not exceed the pressure rating of the 25 mm continuous-flow attachment (25 psig) is approximately 150 gallons per minute (570 liters/minute).

The two exceptions, where rate of flow could be important, are:

1. Where measurements are particularly temperature sensitive, as with Rhodamine and chlorophyll. In these cases, with extremely low flow the fluorometer could raise the temperature of the sample during passage through the flow cell. Although this has not been precisely tested, we expect that a minimum flow of 50 milliliters/minute is safe.
2. In the *in vivo* measurement of chlorophyll, where certain species of phytoplankton exhibit an induction effect if a long opaque hose is used (i.e., the organisms partially dark-adapt). It is recommended that the flow rate not exceed 600 milliliters/minute. High flow rates may yield falsely high readings. Refer to the section on Continuous-Flow Sampling Methods in the monograph "Chlorophyll and Pheophytin," available from Turner Designs.

Centrifugal pumps. These are the least expensive and best suited for use with the Continuous-Flow System. No matter what system is used, keep in mind that the presence of air bubbles will affect measurements; occasional bubbles are not a problem, but continuous, numerous air bubbles will invalidate the measurements.

Submersible pumps. Often used and very satisfactory. A commonly used pump for shallow sampling is a battery-operated bilge pump. Capacity is not important as long as the pump will operate against the head. Remember that once started, and returning to the surface, the head is zero. The problem is that a bilge pump will need help in getting the system primed if the fluorometer is much more than about four feet above the surface. An adequate capacity is 400 gallons per hour. Turner Designs supplies an appropriate sample pump. Refer to the Turner Designs Model 10-AU Digital Fluorometer Ordering Information booklet for specifications.

Above-water pumps. Satisfactory, although they frequently introduce bubbles by air leakage and cavitation. Therefore, it is recommended that this type of pump be mounted on the discharge side of the fluorometer. Keep in mind, also, that the sample is under suction and there is some danger of bubble formation, unless the rate of sampling and the operating head are kept relatively low.



**C. Hoses**

In dye studies, adsorption of Rhodamine WT is not normally a problem in nature. It is not adsorbed significantly on suspended solids. It is, however, adsorbed by soft vinyl tubing (e.g., Tygon) and by rubber and most rubber substitutes. Thus, if you use sample tubing of such material with a high concentration of dye, it may be some time before the fluorometer reading returns to a true background, even though you are sampling an area where there is no dye. In other words, it will take up some dye, then gradually bleed it out. The error will depend on the sampling rate. If the flow rate is high, the error may be minimal.

Polypropylene and high-density polyethylene do not adsorb the tracer. They are, however, stiff and somewhat difficult to work with. The most common sample hose is green garden hose. If you accidentally contaminate it with a high concentration and you must go quickly to low levels, simply be prepared to replace it.

Rubber hose is not recommended.

The hose should be completely opaque, or the portion attached to the intake and exhaust fittings of the fluorometer must be wrapped carefully with black tape. Wrapping a distance of three or four feet from the fluorometer fittings is generally satisfactory, depending on the diameter. The object is to prevent outside light from reaching the photomultiplier tube. To check, shade the hose with the instrument on a sensitive range - direct sunlight and shade should give the same reading.

On the Model 10-AU, both intake and exhaust fittings are 1/2" male pipe thread. For laboratory studies, where smaller intake tubing might be desired, Turner Designs makes a tubing adapter that will accept 3/16" to 1/4" (ID) plastic tubing. Refer to the Turner Designs Model 10-AU Digital Fluorometer Ordering Information booklet.

**D. Dye Injection Pumps**

For some studies using fluorescent dyes, a dye injection device is very useful. For flow rate measurements, an accurate injector is mandatory. There are three basic types of constant-rate injectors: constant displacement pumps, constant-head (gravity-feed) devices, and regulated pressure systems. Turner Designs carries a durable, battery-operated constant displacement injection pump. Refer to the Turner Designs Model 10-AU Digital Fluorometer Ordering Information booklet for specifications.

To decide on the appropriate dye injection device for your study, refer to the section on Dye Injectors in Fluorometric Facts: "A Practical Guide to Flow Measurements," available at no charge from Turner Designs.

**E. Recorders, Data Loggers, and Computers.**

(See Appendix 11A for information about using data collection devices with your Model 10-AU.)

The Model 10-AU Series Fluorometer will operate virtually any recorder. An integrating feature may be desirable for some studies, but special features found on some more expensive recorders, such as logarithmic presentation, X-Y recording, and scale expansion are of little value.

The recorder should be a linear strip-chart recorder with an accurate time drive. A range of chart speeds is valuable, as the speed of paper drive can be adjusted to fit the experiment. A range of 0.05 inch per minute (3 inches per hour) to 2 inches a minute (10 feet per hour) should cover most studies.

An IBM-compatible pocket data logger can also be used to record fluorometer readings.

The Model 10-AU serial data output can be used with an PC-compatible computer or printer, or a Macintosh-compatible computer with a communication program installed.

## Appendix 5 OPERATIONAL PARAMETERS AND DIAGNOSTIC INFORMATION

### A. Operational Parameters

To access the operational parameters, with the HOME screen displayed, press <ENT> to see the MAIN MENU, then press <1>. Press the number of the operational parameter to view it, and follow instructions on the screen to change it. For example, to access screen 1.31, after calling up screen 1.0, press the <3>, then <1>.

The operational parameters are found on the following screens. Refer to Table 4 for defaults and ranges, and to the definitions section following the table.

#### Screen 1.1: Alarm

- 1.11 Monitor alarm
- 1.12 Low level alarm
- 1.13 High level alarm
- 1.14 Alarm delay

#### Screen 1.2: HOME display options

- 1.21 Readout
- 1.22 Units of measurement

#### Screen 1.3: Bar Graph

- 1.31 Display bar graph
- 1.32 Zero point
- 1.33 Full scale
- 1.34 Scale control

#### Screen 1.4: Output

- 1.41 Full scale voltage
- 1.42 Zero point
- 1.43 Full scale

#### Screen 1.5: Serial Data Out

- 1.51 Baud rate
- 1.52 Set interval
- 1.53 Set index
- 1.54 Set format\*

## **Model 10-AU-005-CE Fluorometer User's Manual**

### Screen 1.6: Miscellaneous

- 1.61 Backlight off time
- 1.62 Beeper status
- 1.63 Discrete sample averaging
  - 1.631 Pre-averaging delay
  - 1.632 Averaging period
- 1.64 Security ID check

### Screen 1.7: Temperature\*

- 1.71 Display temperature
- 1.72 Temperature nomenclature
- 1.73 Compensation format
- 1.74 Temperature coefficient
- 1.75 Reference temperature

\* only appears if temperature-compensation package purchased and temperature probe plugged in

**Appendix 5 OPERATIONAL PARAMETERS AND DIAGNOSTIC INFORMATION**

**Table 4. Operational Parameters Defaults and Ranges**

<u>Operational Parameter</u>	<u>Default</u>	<u>Range</u>
Monitor alarm	NO	YES/NO
Low level alarm	0.0	0 - 998.0
High level alarm	999.9	1 - 999.9
Alarm delay	30 (SEC)	10 - 3600 (SEC)
Units of measurement	FSU	NONE, FSU, QFT, PPM, PPB, PPT, mg/l, mg/dl, mg/ml, mg/kg, mg/g, ug/l, ug/ml, ug/kg, ug/g, ng/l, ng/ml, ng/ul, ng/kg, ng/g, ng/mg, pg/g, pg/mg, pg/ug, pg/ml, pg/ul, fg/ul, fg/mg
Display bar graph	YES	YES/NO
Graph zero point	0	0 - 9998
Graph full scale	999	1 - 9999
Bar graph scale control	MAN	AUTO/MAN
Output full scale voltage+	2V	0.1, 1, 2, 5 V
Output zero point+	0	0 - 9998
Output full scale+	999	1 - 9999
RS-232 baud rate++	9600	9600/4800
Serial data out interval++	5 (SEC)	0 - 3600 (SEC)
Serial data out index++	0	0 - 9999
Serial data out format*++	Data only	Data only/data + temp
Backlight off time	300 (SEC)	10 - 3600 (SEC)
Beeper status	ON	ON/OFF
Pre-averaging delay	15 SEC	1 - 60 SEC
Averaging period	10 SEC	2 - 60 SEC
Display temperature*	YES	YES/NO
Temperature nomenclature*	Cel	Fahr/Celsius
Compensation format*	none	none/linear/exp.
Temperature coef. (linear)*	0 %/°C /F	0 - 15 %/°C
Temperature coef. (exp.)*	0 /°C /F	0 - 15 /°C
Reference temperature (C)*	25°C	0 - 100°C
Reference temperature (F)*	77°F	32 - 212°F

+ Analog outputs can be used on Model 10-AU-005-CE with an external data logger or chart recorder (see Appendix 11A).

++ Serial outputs can be used on Model 10-AU-005-CE with an external computer or printer (see Appendix 11A).

\* Visible only if equipped with the optional temperature-compensation package and the temperature probe is plugged into the instrument.

**OPERATIONAL PARAMETERS DEFINITIONS**

**1. Screen 1.1: Alarm**

- a. Monitor alarm. Screen 1.11 allows the user to decide whether or not the high and low level alarms will monitor.
- b. Low level alarm. Screen 1.12 allows the user to define a low level reading that will trigger an alarm.
- c. High level alarm. Screen 1.13 allows the user to define a high level reading that will trigger an alarm.
- d. Alarm delay. A user-settable duration for which the high or low level condition must exist before the alarm is triggered. Helps avoid mistrigging of alarms for transient conditions. Set on screen 1.14.

**2. Screen 1.2: HOME display options**

- a. Readout. Screen 1.21 allows you to select either direct concentration or raw fluorescence readout for display on the HOME screen. If direct concentration is selected, after proper calibration, the Model 10-AU will perform all calculations relating to ranges and fluorescence signal and display the actual concentration of the sample being read.

If you are interested in reading relative fluorescence of samples instead of actual concentration, then choose raw fluorescence data on screen 1.21.

For both options, you can choose whether or not to have blank subtracted.

- b. Units of measurement. The user may select among several different concentration units for display on the HOME and other screens. Note that these units are for display only, and have no direct correlation with concentration. Correlation with concentration is determined during calibration. If you choose to have raw fluorescence data displayed on the HOME screen, then no units will be displayed. (See screen 1.21 above.)

**NOTE:** If you are using the optional internal data logging, you will not be able to access this value when data is logging. This prevents collection of erroneous data. (See Appendix 11D.)

### **3. Screen 1.3: Bar Graph**

The bar graph is an analog display for the readout. More useful in a continuous-flow situation, it is commonly used to provide a visual comparison of concentration changes.

- a. Display bar graph. Screen 1.31 allows the user to decide whether or not the bar graph will be displayed on the HOME screen.
- b. Zero point. The user can set the bar graph zero point on screen 1.32. For example, if your samples are reading primarily in the 50-ppb range, you could set the bar graph zero point to 50 and full scale to 60 in order to use a larger portion of the graph. Readings outside this narrow range will not be displayed. The narrower the range, the greater the resolution.
- c. Full scale. The user can set the bar graph full scale point on screen 1.33. See the example in paragraph b.
- d. Scale control. Automatic or manual control of the bar graph scale can be selected on screen 1.34. In the manual mode, graph zero point and graph full scale are set by the user on screens 1.32 and 1.33. In the automatic mode, when the range is changed, the bar graph full scale will automatically become the full scale value for that range as set during calibration; the graph zero point will be zero.

### **4. Screen 1.4: Output**

Note that the parameters on this screen are for use with external analog data logging devices and will be displayed on the Model 10-AU-005-CE even if you are not connected to an external device. They are operational only in conjunction with an external data logger or chart recorder when connected to the 10-AU through the AC or DC Power & Signal cable. (See Appendix 11A.)

### **5. Screen 1.5: Serial Data Out**

Note that these parameters are for use with external serial data logging devices and will be displayed on the 10-AU-005-CE even if you are not connected to an external device. They are operational only in conjunction with an external computer or printer when connected to the 10-AU through the AC or DC Power & Signal cable. (See Appendix 11A for details.)

**6. Screen 1.6: Miscellaneous**

- a. Backlight off time. On screen 1.61 the user may set the time for the backlight to be on without a keypress before it automatically goes off.
- b. Beeper status. The audio beeper, which sounds when a key is pressed and when an alarm is triggered, may be turned on or off on screen 1.62.
- c. Discrete sample averaging. Discrete sample averaging is a very useful feature for ensuring consistent readings on discrete samples. It allows you to average the readings over a user-settable period, and freeze the digital display for 10 seconds so you can note the reading. Thus, each sample can be read after the same amount of time has passed; and the averaging and freezing of the display minimizes both the inconvenience and potential error when readings fluctuate.

This function is particularly useful with temperature-sensitive samples. With discrete samples, correction for temperature changes is difficult to do accurately without stirring. To ensure accuracy, before taking a reading you must wait long enough for the reading to stabilize, but not long enough for temperature changes to have a significant effect. Taking a reading at a fixed time after sample insertion ensures constant temperature conditions.

To use this function, set the pre-averaging delay and the averaging period on screens 1.631 and 1.632 (see below), or you may use the default values. The default values are 15 seconds and 10 seconds, respectively.

To initiate an averaging sequence, press <\*> on the HOME screen. The word "DELAY" will appear in the upper right-hand corner while the pre-delay is in effect. Then "AVE" will appear for the averaging period. When the sequence is finished, "DONE!" will be displayed and the readout will freeze for 10 seconds, displaying the averaged readout.

NOTE: If you are using the Model 10-AU with an external computer, the "frozen" reading from the HOME screen is what will be recorded during the 10-second "freeze" period.

To abort the sequence, go to another screen by pressing <ENT>, or <ESC> if "ALARM ON!" is flashing. Pressing <\*> again while the averaging is taking place aborts the current sequence and starts a new one.



## **Appendix 5 OPERATIONAL PARAMETERS AND DIAGNOSTIC INFORMATION**

1. Pre-averaging delay. Once a sample is placed in the sample compartment and the light cap replaced, it takes a few seconds for the reading to stabilize. How much time depends on the sensitivity setting for the Model 10-AU and the saturation of the photomultiplier tube. The pre-averaging delay allows you to set the delay period to the minimum, but adequate, time for your readings to stabilize before the averaging period begins. Fifteen seconds is usually more than adequate. To determine the time required, place a sample in the sample compartment, replace the light cap, and see how long it takes for the reading to stabilize. Keep the light cap on between readings to avoid saturation of the photomultiplier tube.
2. Averaging period. This is the length of time the readout will be averaged. You may select an averaging period from 2 - 60 seconds. Generally, a longer averaging period helps to minimize fluctuating readings. Keep in mind, however, that the sample temperature will increase the longer it remains in the instrument, leading to possible temperature-related errors. (See the discussion about temperature in Appendix 6A.)
- d. Security ID check. For security reasons, some users have found it useful to require the entry of an ID to prevent accidental changing of fluorometer settings. To enable the security ID, access screen 1.64. Once enabled, a four-digit ID will be required to access any screens other than the HOME screen. If a key is not pressed on the keypad for 30 minutes, the fluorometer will jump to the HOME screen, and an ID will have to be entered again to access any other screens.

The 4-digit ID is a combination of the date and time as displayed on the HOME screen. Thus, it changes every minute, but you always know what it is. For example, if the time on the HOME screen is 5:14:21 PM, and the date is 9/23/91, the ID is 3241: the time in minutes (14) plus the day of the month (23), in reverse order.

### **7. Screen 1.7: Temperature**

This will be displayed on the 10-AU-005-CE, only if the temperature-compensation package has been purchased and the temperature probe is plugged into the instrument. The temperature probe operates only when using the continuous-flow cuvette system. For a discussion of temperature and fluorescence, see Appendix 6A.

**NOTE:** If you are using the temperature-correction capabilities of your Model 10-AU, temperature values must be set before calibration, and **YOU MUST RECALIBRATE** whenever you change the temperature format or coefficient, or the reference temperature.

## **Model 10-AU-005-CE Fluorometer User's Manual**

- a. Display temperature. On screen 1.71, the user may decide whether or not temperature of the sample in the continuous-flow cuvette will be displayed on the HOME screen.
- b. Temperature nomenclature. Temperature can be set to either Celsius or Fahrenheit on screen 1.72.
- c. Compensation format. On screen 1.73, the user can choose none, linear, or exponential formats for the temperature coefficient. Temperature correction is correctly done with the exponential format; the linear format is included for convenience and because some researchers have used it in the past. The linear format should be used only if there is a very small temperature coefficient, as the error will escalate rapidly with increasing temperature differences.
- d. Temperature coefficient. The fluorescence readings for a particular substance vary in a fixed amount with temperature. The temperature coefficient, fixed for various substances, compensates for this variance. The temperature coefficient for the analyte you are measuring can be entered on screen 1.74. See the Temperature Coefficient table in Appendix 6, page A6-1 for temperature coefficients. Be sure you select the appropriate temperature nomenclature (C/F) on screen 1.72 AND the correct compensation format (linear or exponential) on screen 1.73.
- e. Reference temperature. This is the base temperature, usually room/ambient temperature, to which fluorescence readings are compared when a temperature compensation is made. Set on screen 1.75.

### **B. Diagnostic Information**

The Model 10-AU has two diagnostic screens, 3.1 and 3.2, which contain information about the status of internal fluorometer functions and readings. (See Table 2 in Section 4, for defaults and ranges for internal fluorometer functions.)

If the readings on screen 3.1 and 3.2 are normal, it is highly probable that the fluorometer is functioning correctly.

These screens are accessed from the Main Menu by pressing <3>.

## Appendix 5 OPERATIONAL PARAMETERS AND DIAGNOSTIC INFORMATION

### 1. Screen 3.1.

Indicates the power level in percentage. Confirms **AC power** is at 115 V when reading is 100%. If your instrument is operating on **230VAC**, as long as the power level is greater than 10%, the instrument will function properly. For **DC power**, 10.2 V is 0% and 12 V is 100%. We have found that a 12-volt battery indicates approximately 70%; this is more than adequate. The **low power level alarm** will be triggered if the power level falls below 10%.

**INSTRUMENT TEMPERATURE** indicates the internal temperature of the fluorometer. If temperature rises above 90°C or falls below -20°C (based on internal sensor, accuracy: +/-5°C), it will trigger an alarm.

Indicates the speed in rpm of the chopper motor (which spins an optical device). It is regulated to 600 rpm, +/- 1% by internal software and hardware. If it falls below 500, an alarm is triggered.

```
Diagnostic:
Pwr level: 100%   Instr temp: XX (C)
Chopper RPM: 601 Lamp:      ON
High Volt: XXX (V)-----Within Range
Ckt status: XXXX-----OK
Oper hour: XXX   Oper since: xx/xx/xx
<ENT> to next screen      #3.1
```

**LAMP** reports whether the lamp is OFF/BAD or ON.

**OPERATION HOUR** shows how many hours the instrument has been operated.

**OPERATION SINCE** shows the earliest date at which the instrument has been operated continuously for one hour.

**CIRCUIT STATUS** reports a numerical value and whether it is OK or failure. The value depends on the range the fluorometer is in. In HIGH, it should be about 36; in MED about 360; in LOW about 3600.

**HIGH VOLTAGE** reports a numerical value and whether that value is Within Range, or Too High or Too Low. High voltage is one indication of the current operating level of the fluorometer. The number will vary: the higher the number the lower the concentration range (and typically, the greater the "noise" of the readings). High voltage will be lowest when the instrument is in the HIGH concentration range, intermediate when in the MED range, and highest in the LOW concentration range. High voltage can be increased or decreased using the Sensitivity Adjustment Knob. Once you have set the basic operating level and LOCKED the Sensitivity Knob Lock, high voltage should remain relatively stable for each of the ranges. It is a good indicator of the stability of the instrument; thus, you might want to record the high voltage level whenever you read a series of samples.

**2. Screen 3.2**

Output (0 to 9999.999), based on putting the fluorescence signal into the Fluorescence Readout formula below, without temperature compensation. This value is sent to digital display (rounded off to 3 digits), unless you have purchased temperature compensation, and it is activated, with the temperature probe in place; in which case, Temp. comp. readout is sent to the digital display.

This appears only if the optional temperature compensation package has been purchased and temperature probe is in place. See definition and formula in Appendix 5B, section 2b.

Output from the photomultiplier tube.

Stored value of fluorescence signal for the standard solution set and stored on screen 2.3, Run Standard Solution, with blank subtracted (unless you set screen 2.12 to "NO").

Full scale (FS) functions like an analog meter. It indicates the current sample's percentage of full scale reading at the current concentration range (without temperature compensation). It is also used to set the basic operating level of the instrument before operating for the first time.

Temp. comp. readout: XXXX.XXX  
 Fluorescence readout: XXXX.XXX  
 PM signal output: XXXX.XXX

Cal std val: XXX.XX    Blank: XX.XXX  
 FS: XX% of XXXX.XXX (PPB) at MED  
 Span level%: 48  
 <ENT> to next screen                      #3.2

Stored value of fluorescence signal for blank solution set and stored on screen 2.11, Run Blank. This value will be used by the instrument to calculate direct concentration or raw fluorescence (unless you set screen 2.12 to "NO"). Blank is not temperature compensated.

Indicates the sensitivity of the instrument as set during calibration on screen 2.11, Run Blank, and screen 2.3, Run Standard Solution. Range is 0 - 99%, with a default of 48%. Span is a fine adjustment of sensitivity. Coarse adjustment is made using the Sensitivity Adjustment Knob (*details in Appendix 6B*).

**Fluorescence readout formula:**

$$\frac{\text{Standard Soln Conc.} \times \text{Sample Output}}{\text{Cal std val}}$$

Actual concentration of standard solution as entered on screen 2.2 during calibration.

Stored value of fluorescence signal for the standard solution (set and stored on screen 2.3, Run Standard Solution) with blank subtracted (unless you set screen 2.12 to "NO").

Fluorescence signal at a given range for current sample (range depends on the sensitivity), with blank subtracted (unless you set screen 2.12 to "NO").

## **Appendix 5 OPERATIONAL PARAMETERS AND DIAGNOSTIC INFORMATION**

### **2. Screen 3.2 (continued)**

- a. Reading Samples on Screen 3.2. You may find it desirable or necessary to read samples with more than the three significant digits available on the HOME screen. You may do so by reading directly from screen 3.2. If you are reading direct concentration, the units you chose on screen 1.22 will be displayed. If you are interested in raw fluorescence, then "RAW" will appear next to the readout.

Calibrate the Model 10-AU following the normal procedure in Section 3F. Then, access screen 3.2, insert a sample and record the "Fluorescence readout." If you are using the optional temperature-compensation package, record the "Temp. comp. readout."

See Section 3G on Routine Operation for a discussion of auto-ranging, etc. If the readout displays "OVER," it means the concentration reads higher than full scale for the present range as currently calibrated. If you are in the Manual mode, reading on the MED range and the reading is "OVER," access screen 2.42 and change to the High range. Return to screen 3.2 to view the readout.

If the reading is OVER on the High range, then the concentration exceeds the upper limits of detectability of the Model 10-AU as currently calibrated. You might try diluting the sample 1:1 until you obtain an on-scale reading to get some idea of the concentration. Or, you can reduce the sensitivity of the instrument by recalibrating and reducing the Span level. Or, consider changing reference filters, or to a smaller cuvette size, or adding an attenuator plate. (See the discussion on decreasing sensitivity in Appendix 6A.)

Display reads ">9999". If the reading exceeds 9999.999, the maximum allowable for the screen 3.2 readout, the readout will display >9999. Access screen 2.2 and reduce the standard solution concentration by a factor of 10. I.e., if it was 500, set it to 50, or 5, if necessary to make the full scale reading less than 9999. If you do this, make note of the factor, as all of your samples will have to be multiplied by this factor to determine the actual concentration or relative fluorescence.

Minus. If the readout has a minus sign in front of it, it means that the sample is less concentrated than blank. This is more likely where you have calibrated with high blank. See Section 3E3 for what to do for high blank. It is also possible that your standard or blank solutions are contaminated. If you suspect this, remake your standard and check your blank against a fresh blank or distilled water.

- b. Temp. compensated readout is the value sent to the digital display (rounded off to three digits), based on putting the temperature-compensated fluorescence output for the sample and the standard solution into the formula on the Screen 3.2 page, above. (Blank is not temperature compensated.)

NOTE: Temp. comp. readout will not appear unless your instrument is equipped with temperature compensation and the temperature probe is in place. It will read the same as "fluorescence readout" if the compensation format on screen 1.73 is set to "NONE" or if the temperature coefficient is set to "0" on screen 1.74.

For the linear compensation format:

NOTE: The linear compensation format is correctly used only with small temperature coefficients. See Appendix 5A, subsection 7c.

Temperature-compensated fluorescence output =

fluorescence output x {1 + [Temp. coef. x (Sample temp. - Ref. temp.)]}

Where:

Fluorescence output is the stored value of fluorescence signal for the standard as set during calibration (Cal std val), or the fluorescence signal for the sample (Sample Output).

Temp. coef. is the temperature coefficient of the sample (item 4 in screen 1.7).

Sample temp. is the current sample temperature (C or F degrees).

Ref. temp. is the reference temperature (item 5 in screen 1.7).

## Appendix 6 CALIBRATION CONSIDERATIONS

### A. Calibration Considerations

Temperature. Most fluorescent materials have fairly high temperature coefficients. Usually, as temperature increases, fluorescence signal decreases. Unless corrected for, this can produce significant errors.

For this reason, the standard, the blank and the unknowns should all be read at the same temperature, or the fluorescence readings corrected for temperature.

TEMPERATURE COEFFICIENTS				
	EXPONENTIAL		LINEAR	
	/°C	/°F	%/°C	%/°F
<b>Rhodamine WT</b>	0.026	0.0144		
<b>Rhodamine B</b>	0.027	0.0150		
<b>Fluorescein</b>	0.0036	0.0020		
<b>Chlorophyll (90% acetone)</b>			0.3	0.1667
<b>Chlorophyll (in vivo)</b>			1.4	0.7778

**Automatic Temperature Compensation.** If you have purchased the optional temperature-compensation package, the 10-AU-005-CE will perform temperature correction on the standard and sample readings for you, once you have set the temperature-related values. Blank is not temperature compensated. The temperature probe operates only when using the continuous-flow cuvette.

If you have temperature-compensation **capability and the temperature probe is plugged in**, your Model 10-AU will display screen 1.7. The table above sets forth the temperature coefficients to enter on screen 1.74. Be sure you select the appropriate temperature nomenclature (C/F) on screen 1.72 AND the correct compensation format (linear or exponential) on screen 1.73.

For details on setting the temperature-related values, refer to the definitions under screen 1.7 in Appendix 5A.

**NOTE:** If you are using the temperature-correction capabilities of your Model 10-AU, **YOU MUST RECALIBRATE** if you change the temperature format or coefficient, or the reference temperature.

**Temperature Considerations Using the Cuvette Holder.** With the Discrete Sample Cuvette Holder, you can measure the temperature with an external thermometer and compensate for changes with the appropriate temperature-compensation formula. Or, use a waterbath or other temperature regulator and take readings for blank, standard, and samples at the same temperature. If, however, you are using a waterbath, wipe each test tube thoroughly, but quickly, with a lint-free tissue (such as Kim Wipes) before reading. Any sample read and returned to the bath should not be re-read for at least ten minutes. Even if the reading has not begun to change in the instrument (an indication that the temperature has changed), the tube will have warmed slightly and the sample temperature may increase after it is removed.

The discrete sample averaging capability of the Model 10-AU can also be used to help minimize error resulting from temperature differences. (See Appendix 5A, screen 1.63.)

**Linearity and Concentration Quenching.** The readout of the Model 10-AU Fluorometer is directly proportional to concentration from the smallest detectable concentration to a concentration specific to the fluorescent material, the wavelengths being used, and the path length. Above some concentration the measurements become non-linear. (See Appendix 10 for approximate linear ranges.)

As the concentration of the sample is further increased beyond linearity, the fluorometer reading rises at a decreasing rate and eventually begins to decrease, even though the concentration is still increasing. In effect, "concentration quenching" results in non-linearity.

For example, the fluorescent dyes provide linear readings from the limit of detectability of about 10 parts per trillion to about 0.1 ppm. As a rule of thumb, linearity should be checked when measuring concentrations of dye higher than 0.1 ppm, using the 25 mm Continuous-Flow Cuvette or 25 x 150 mm Cuvette Holder. (For other cuvettes, refer to the instructions accompanying them.)

At dye concentrations below 0.1 ppm, a single-point calibration (one standard and a blank) may be used to calibrate the Model 10-AU. For concentrations between 0.1 and 0.5 ppm, a multi-point calibration curve (using multiple concentrations of the standard) must be prepared, or the samples must be diluted and the reading obtained multiplied by the dilution factor. (Much above 0.3 parts per million, dilution will be more accurate.) Above 0.5 ppm, "concentration quenching" occurs, and samples should be diluted into the linear range before taking readings.



## **Appendix 6 CALIBRATION CONSIDERATIONS**

Linearity may be checked by diluting a sample 1:1 or some other convenient ratio. If it is linear, the reading will decrease in direct proportion to the dilution. If the reading goes up ("concentration quenching"), you are beyond the range for a calibration curve. If the reading does not decrease in direct proportion to the dilution, you are in the range for a calibration curve, but beyond the linear range.

**Changing Applications.** You set the basic sensitivity of the Model 10-AU using the Sensitivity Adjustment Knob before calibrating for the first time. If you change the lamp, filters, or cuvette size, you will have to readjust the Sensitivity Adjustment Knob. See Appendix 6B below. **DO NOT ADJUST** the Sensitivity Adjustment Knob otherwise. It is not necessary and it will disrupt your study.

### **Calibrating With the Continuous-Flow System**

The 25 mm Injector Flow Cell is designed with a valve and Luer-lock injection port which allows injection of the standard and blank directly into the flow cell.

If the instrument does not have the Injector Flow Cell, then accurate calibration can be made by setting up the 10-AU so that the continuous-flow cuvette may be poured full of the standard and blank. Several flushings are required to eliminate any trace of the preceding sample. To ensure complete filling of the cuvette without having any large bubbles trapped, it is best to fill through the lower Intake Fitting. Significant air bubbles will greatly affect the accuracy of your readings. This method must be used when working with the 3 mm or the 1 mm flow cell.

However, when calibrating with the flow-through method, it is difficult to know the sample temperature. If you have purchased the optional temperature-compensation capability, this will simplify calibration using the flow-through method. (See Appendix 5A, screen 1.7.) If you have not, and temperature compensation is important to your study, note that simply measuring the temperature prior to filling the cuvette is not sufficient. The cell itself may be warm and will quickly warm the sample. It is best to pump the standard through the cell and measure it while it is flowing.

Alternately, you could prepare a valving system in which standard, blank, and unknown are pumped through the fluorometer in identical fashion. Such a system could include a means of stopping flow, to conserve on standard. If you do stop flow, do it only briefly as the instrument will warm the solution.

Note that with a few exceptions, the flow rate through the Continuous-Flow Cuvette System is not important and is at the operator's discretion. (See Appendix 4B, Flow Rate.)

You **CANNOT** calibrate the 10-AU by installing the Discrete Sample Cuvette Holder (25 x 150 mm), calibrating the instrument, then switching back to

the continuous-flow system. The systems have a slightly different calibration factor and results will not be accurate. Note that you MAY set the basic operating level of your instrument using the discrete sample holder (as set forth in Appendix 6B, following). The difference between the two systems is not significant for this procedure; and after proper calibration your results will be accurate.

**Cuvettes.** Cuvettes must be clean and dry on the outside. Take particular care not to contaminate your samples, especially if working with low concentrations.

If quartz cuvettes are used, rinse them thoroughly before reusing. If possible, read samples progressively, from low to high concentrations; you will achieve more accurate readings, and contamination is not as significant.

**Averaging Readings.** When working with test tube samples, keep in mind that there can be slight variations from tube to tube. For this reason, it is common to have three (or more) tubes of standard and to average the readings. You may also use replicate samples as well. It is for you to determine how important the reading of one sample is.

**Bubbles in the Sample.** The presence of bubbles in your sample, even minute ones, will affect your readings, producing erratic or fluctuating readings. If bubbles occur in test tube samples, you can wait for them to settle; or cap the test tube and rotate it gently from side to side and up and down.

In continuous-flow systems, if bubbles are present, check your delivery system for leaks. Make sure the pump you have chosen is the best for your study. (See Appendix 4B.)

**Storage of samples.** The storage material must be compatible with the solvent and must not adsorb or affect the sample. Borosilicate glass is usually acceptable for all samples. Ordinary glass sometimes has outcroppings of soda lime, which can affect pH in poorly buffered samples. Fluorescence is generally more sensitive to pH than is absorption spectroscopy. The fluorescence of Rhodamine WT, for example, is relatively consistent between 4 and 10.5, but drops sharply beyond these extremes.

**Increasing Sensitivity.** Sensitivity can be increased using the Sensitivity Adjustment Knob. (See Appendix 6B.)

Sensitivity can also be increased by using a larger cuvette size. If you have increased sensitivity to its maximum using the Sensitivity Adjustment Knob, and have tried reading samples on the Low concentration range, with Span close to 100%, and find you could still use more sensitivity, switching to a larger cuvette size will help. (See Appendix 10.)

## Appendix 6 CALIBRATION CONSIDERATIONS

Sensitivity increases with increasing cuvette size: the 25 mm cuvette is the most sensitive, then the 10 mm (analogous to the 13 x 100 mm Cuvette Holder), and finally the 3 mm Continuous-Flow Cuvette. (See the Turner Designs Model 10-AU Digital Fluorometer Ordering Information booklet.)

Sensitivity may be increased by a factor of 10 by installing a 1 ND (neutral density) reference filter. A 2 ND reference filter will increase sensitivity by a factor of 100. (For information on filter installation, see Appendix 8.)

**Decreasing Sensitivity.** Sensitivity can be decreased using the Sensitivity Adjustment Knob. (See Appendix 6B.)

Sensitivity can also be decreased by using a smaller cuvette size (10 mm, 3 mm, or 1 mm by special order). If you have decreased sensitivity to the minimum using the Sensitivity Adjustment Knob, and have tried reading samples on the High concentration range, with Span close to 0%, and find you would still like to reduce sensitivity, switching to a smaller cuvette size will help. (Appendix 10.)

Adding an attenuator plate to the excitation filter holder can also reduce sensitivity. There are two sizes: the 1/4" attenuator, which reduces sensitivity by a factor of 5; and the 1/16" attenuator plate, which reduces sensitivity 75-fold. (See Appendices 8 and 9.)

If a 1 ND or 2 ND reference filter is installed, removing it will decrease sensitivity by a factor of 10 for the 1 ND and 100 for the 2 ND. (See Appendix 8 for removal instructions.)

**B. Setting the Basic Operating Level Using the Sensitivity Adjustment Knob**

1. Introduction

You must set the basic operating level (sensitivity) of your Model 10-AU using the Sensitivity Adjustment Knob BEFORE calibrating your instrument for the first time. Thereafter, it will not be necessary to readjust the Sensitivity Adjustment Knob unless you change to a different cuvette size or a different kind of lamp or filters; or unless you want to significantly increase or decrease sensitivity. DO NOT ADJUST the Sensitivity Adjustment Knob otherwise. It is not necessary and it will disrupt your study. If you adjust the Sensitivity Adjustment Knob, you must recalibrate the instrument or your readings will be inaccurate.

The Model 10-AU is extremely sensitive and in most applications can read a broad range of concentrations with great accuracy. After setting the operating level using the Sensitivity Adjustment Knob, the instrument will have a range of about 5,000,000 to 1 (i.e., 500 ppm to 0.1 ppb) using only the Span and concentration ranges to adjust sensitivity.

The operating level will be set on screen 3.2 by adjusting the FS% using the Sensitivity Adjustment Knob. Operating level will be adjusted with the calibration settings in the default position (reset to default on screen 2.6).

You will need a standard concentration that is approximately 50% of the maximum concentration you wish to read. Make sure the maximum selected is within the linear range for your substance (see Appendix 6A). (See the sections below for details about Rhodamine WT or chlorophyll.) Note that the higher the concentration you choose to read, the more resolution you will sacrifice when reading low samples. Thus, be reasonable when considering your maximum. The broader the range of concentrations you are trying to read, the greater the loss of resolution on the low end.

If you are interested in reading very low concentrations (close to the minimum levels of detectability), you should also have a very low standard concentration on hand to verify that you can distinguish it from blank. (See Appendix 10.)

Sensitivity of the Model 10-AU is at maximum when the instrument is in the LOW range, Span at 100%, and the Sensitivity Knob is fully clockwise.

Feel free to experiment with various Sensitivity Adjustment Knob settings to find one that works for you. You can't hurt the instrument by changing the Knob setting, though you should do your experimenting before you

begin your actual study, as **changing the Sensitivity Knob requires recalibration** and readings on one sensitivity setting do not necessarily compare exactly with readings on a different setting. (But see Appendix 6C for the procedure for retrieving a former sensitivity setting.)

### 2. Setting the Sensitivity Adjustment Knob

This is a *general method* for setting the operating level. It should allow you to read the maximum concentration you selected and give you adequate sensitivity for low concentrations--assuming the maximum you selected is within the linear range for the instrument.

Please see the sections below on Rhodamine and chlorophyll for suggestions specific to those applications.

- a. Prepare or obtain a calibration standard solution that is about 50% of the maximum concentration (within the linear range) you wish to read.
- b. Turn on the fluorometer and allow it to warm up for at least 10 minutes.
- c. Access screen 2.43 and set the concentration range control to MAN.
- d. On screen 2.42, set the instrument to the MED concentration range. (For certain studies, e.g., *in vivo* chlorophyll or oil, you may use the LOW or HIGH ranges, respectively.)
- e. On screen 2.6, reset the calibration values to their default values. At default the values are: 1. Blank reads zero; 2. Cal std val reads 50.000; 3. Standard solution concentration reads 15.000; Span reads 48%; and maximum for the Full Scale Value Table reads 900 for High, 90 for MED, and 9 for Low.
- f. Access screen 3.2. The third line from the bottom will read: FS%: XX% of 90.000 units at MED. The full scale (FS) reading is dependent upon the concentration of any sample in the sample compartment and the current sensitivity adjustment.
- g. Unlock the Sensitivity Adjustment Lock with an Allen wrench (see Section 2B, Figure 1, for location).
- h. Fill the clean flow cell or a cuvette with the calibration standard solution.

- i. Adjust the Sensitivity Adjustment Knob (the large recessed knob located at the lower right of the keypad; see Figure 1, Section 2B) until the FS% (third line from the bottom) reads approximately 40-60%; i.e., "FS%: 55% of 90.000 units at MED." It is not necessary to be exact.

Turning the Sensitivity Knob clockwise increases sensitivity (FS%); turning it counterclockwise decreases sensitivity (FS%).

The Sensitivity Adjustment Knob is very responsive and even a small adjustment can cause a great change in readings. Thus, the proper way to adjust the Sensitivity Adjustment Knob is to turn it very slightly (using a coin), then pause until the reading reaches equilibrium, then adjust, pause, etc., until the desired reading is obtained.

There is a clutch mechanism that prevents damage if the control is turned beyond its maximum and minimum ranges. When you have reached the maximum or minimum, the FS% will not change, even though you turn the control.

On screen 2.5, the Time Constant can be set to 1, 2, 4, or 8 seconds. Setting the Time Constant to 1 or 2 seconds will provide a faster response time.

If the FS% is less than 10% and barely changes no matter which direction you adjust the Sensitivity Knob, make sure the Sensitivity Adjustment Lock is unlocked. Then, check to make sure that the calibration standard solution you are using is an accurate dilution. If the FS% still barely changes when the Sensitivity Knob is turned, it is likely that the range selected is not sensitive enough for the application and sample you are trying to read. If you are in the MED range, go to screen 2.42 and change to the LOW range (if in HIGH, change to MED). Return to screen 3.2 and adjust the Knob until the FS% reads 40-60% of MED or 40-60% of LOW.

If you cannot obtain adequate sensitivity in the LOW range, refer to the procedure for reading very low concentrations, in the Chlorophyll section below, and to Appendix 6A, for methods for further increasing sensitivity.

If the FS% on the HIGH range reads greater than 111% and will not go below 100% with the Sensitivity Knob fully counterclockwise, the concentration is too high to be read by the

## Appendix 6 CALIBRATION CONSIDERATIONS

instrument at the current sensitivity levels. You can dilute the calibration standard solution until the FS% can be adjusted to less than 100% (this will lower the maximum concentration you can read). Or, see Appendix 6A for ways of further decreasing sensitivity.

To find the maximum concentration (full scale) you will be able to read at the current settings, after the FS% is set on screen 3.2 (assuming FS% was set with Span at default of 48%):

**Maximum concentration (FS) =**

$$\frac{\text{Concentration of calibration standard} \times 500}{\text{FS\%}}$$

Range FS% was set on	FS on HIGH	FS on MED	FS on LOW
HIGH	FS	FS , 10	FS , 100
MED	FS x 10	FS	FS , 10
LOW	FS x 100	FS x 10	FS

**NOTE:** FS (maximum concentration) is NOT the same as FS%.

- j. When the desired reading is obtained, LOCK the Sensitivity Adjustment Lock by turning it clockwise with the Allen wrench. The basic sensitivity is now set, and you will use the Span and concentration ranges during calibration to set sensitivity for your study.
- k. Press <ESC> to get out of screen 3.2.
- l. Calibrate your Model 10-AU following the normal procedure. (See Section 3F.)

3. Setting the Sensitivity Adjustment Knob for Rhodamine

Using the 25 mm cuvette, Rhodamine WT (and B) readings are linear to approximately 100 parts per billion--active ingredient. (Rhodamine WT usually comes as a solution of about 20% active ingredient. Thus, if dilutions were made treating the dye as 100% tracer, the resulting dilutions would be linear to 500 ppb.) We have found that the 10-AU provides satisfactory readings for most studies when the Sensitivity Adjustment Knob is set using the concentrations, range, and FS% in Table 5. However, please note that the FS% is a rough sensitivity adjustment. It is not necessary for satisfactory operation to achieve an FS% within the exact recommended range.

Follow the procedure in subsection 2 above, referring to Table 5 for appropriate settings. For example, if you are using a 20 ppb (active ingredient) concentration, in step d you will select the MED range, and in step i you will set the FS% to 70-90%.

For instructions for preparing dye standards, ask us for our monograph: "Preparation of Standards for Dye Studies Using Rhodamine WT."

<b>Rhodamine<sup>1</sup></b>	<b>Cuvette</b>	<b>Conc. to use</b>	<b>FS%</b>	<b>Range</b>
20% active ingredient	25 mm	20 ppb	70-90 <sup>2</sup>	MED
As 100% tracer	25 mm	100 ppb	70-90 <sup>2</sup>	MED

- 1 Rhodamine WT is often supplied as a 20% aqueous solution, i.e., as 20% active ingredient.
- 2 Please note that this is a very flexible setting. If, after setting the instrument to this level, you find that OVER appears frequently when reading samples, then reset basic sensitivity on the HIGH range to an FS% of 30-50%. If superior resolution for low concentrations is desired, then use a low concentration standard (2 - 5 ppb) and set FS% to 70-90% on the LOW range.



4. Setting the Sensitivity Adjustment Knob for Chlorophyll

**a. Extractive Methods**

Most researchers will use the 13 mm cuvette for extracted chlorophyll.

Using the 13 mm cuvette, the US Environmental Protection Agency has found detection limits of 0.05 µg/L (ppb; or 50 parts per trillion); the upper limit of linearity was 250 µg/L. (For Method 445.0, contact Turner Designs for Method 445.0, "*In Vitro* Determination of Chlorophyll *a* and Pheophytin *a* in Marine and Freshwater Phytoplankton by Fluorescence." Or, refer to our website: [http://www.turnerdesigns.com/applications/998\\_6000.htm](http://www.turnerdesigns.com/applications/998_6000.htm) or the U.S.E.P.A. website: <http://www.epa.gov/nerlcwww/marinmet.htm> )

Contact Turner Designs about ready-to-use chlorophyll standards in 90% acetone and stable solid secondary standards.

We have found that the Model 10-AU provides accurate readings when the Sensitivity Adjustment Knob is set using the concentrations, range, and FS% in Table 6.

Follow the procedure in subsection 2 above, referring to Table 6 for appropriate settings. For example, using a 150 ppb standard, in step d you will select the HIGH range, and in step i you will set the FS% to 30-50%.

If you cannot obtain the recommended FS%, try installing a 2 ND reference filter. (See Appendix 8 for instructions.) This will increase the sensitivity by a factor of 100.

If you can't reduce the FS% to 100 or below, check to see which reference filter is in place. If it is a 2 ND, replace it with a 1 ND or simply remove the 2 ND filter and set sensitivity without a reference filter. (See Appendix 8 for replacement instructions.)

**b. *In vivo* Continuous-Flow Method**

The Model 10-AU is often used aboard ship with the 25 mm continuous-flow cuvette. To set the basic operating level, follow the procedure in subsection 2 above, referring to Table 6 for appropriate settings. For example, in step d go to the MED range. While sample lake or marine water is flowing through the instrument, in step i, set the FS% to approximately 30-80%. If FS%

is greater than 111% on the MED range, switch to the HIGH range and set the FS% to 30-80%. If you can't reach the desired FS% on the MED range, switch to the LOW range and set to 30-80%.

Note that in most cases you will be setting the basic operating level with an unknown sample from the body of water you are investigating. During the calibration procedure while running the standard on screen 2.3, you should take a grab sample of the water immediately after it passes through the flow cell for later extraction to determine actual chlorophyll concentration. You will then use a ratio method to compare all other readings with the standard. (See Section 3G, Routine Operation.)

**NOTE:** For *in vivo* chlorophyll studies in natural systems (where sample water flows through the instrument's flow cell without pretreatment), the fluorometer reading is NOT the actual concentration of chlorophyll present. It is, however, directly proportional to actual concentration. The actual concentrations of chlorophyll will be determined later by comparing instrument readings to a known concentration of your sample determined using an extractive method such as EPA Method 445.0. The *in vivo* method greatly reduces the number of samples that must be extracted, providing a reliable "map" of chlorophyll concentrations where large numbers of samples are to be read.

**c. Reading Low Concentrations *in vivo* or Extracted**

Chlorophyll can be detected as low as 10 parts per trillion using the Model 10-AU. Some researchers have reported detecting single cells. Detectability levels are, however, highly species dependent and affected by the health and development of the particular organism.

To obtain maximum sensitivity levels, use the 25 mm cuvette. Install a 2 ND reference filter (see Appendix 8).

Take a very low sample, say 50 parts per trillion (0.05 µg/L).

Follow the procedure in subsection 2 above, referring to Table 6 below for recommended settings. For example, in step d go to the LOW range. Gently swirl the cuvette before inserting into the instrument (step h). Adjust the FS% in step i to 5-25%, with 25% preferred. Note the PM signal output (screen 3.2). Some fluctuation should be expected as the instrument is operating at a very high level of sensitivity.

## Appendix 6 CALIBRATION CONSIDERATIONS

Remain on screen 3.2. Put in a clean 25 mm cuvette containing a blank solution. Note the FS% and the PM signal output and compare it to the FS% and the PM signal output for the 0.05 µg/L sample. Is the sample reading distinguishable from the blank?

If not, it might help to install the 10-318 (1/4") attenuator plate (see Appendix 8 for instructions). With this plate, you will be able to turn up the sensitivity and may find better resolution of low samples as compared to blank. If this doesn't help, it probably means your particular sample is not detectable by the Model 10-AU at that low a concentration.

<b>Chlorophyll</b>	<b>Cuvette</b>	<b>Conc. to use<sup>2</sup></b>	<b>FS%<sup>3</sup></b>	<b>Range</b>
Extracted <sup>1</sup>	13 mm	150-200 µg/L	30-50	HIGH
"	"	<u>or</u> 15 - 20 µg/L	30-50	MED
"	"	<u>or</u> 2 - 5 µg/L	70-90	LOW
<u>In vivo</u> (flow)	13 mm	unknown	30-80	MED or LOW
Low concentration	25 mm	0.05 µg/L	5-25	LOW

- 1 For extracted chlorophyll, you can use either the low or the high concentration standard (prepared chlorophyll standards in 90% acetone available from Turner Designs).
- 2 These concentrations need not be exact, as readings will be adjusted during calibration. The idea is to obtain a satisfactory sensitivity level. These are not the only concentrations you can use; they are to give you basic recommendations as to concentration, range, and FS%.
- 3 Please note that this is a very flexible setting. If, after setting the instrument to this level, you find that OVER appears frequently on the HIGH range when reading samples, then reset basic sensitivity to a lower FS%. If the best resolution for low concentrations is desired, see subsection C, above.

### C. Sensitivity Setting Retrieval

It is possible to retrieve a previous sensitivity setting on the Model 10-AU. To do so, three settings must be noted during calibration. In addition, the same filters and lamp must be used, installed in exactly the same position as for the previous study. The same size cuvette must also be used. A retrieval can be done with an error of less than 0.5% if the Sensitivity Adjustment Knob has not been changed.

## **Model 10-AU-005-CE Fluorometer User's Manual**

If the Sensitivity Adjustment Knob has been changed, the characteristics of your instrument's photomultiplier tube, the time elapsed between studies, and the operating temperature will affect the accuracy of the retrieval. For a fairly accurate retrieval, perform the retrieval procedure no more than two weeks after the former study, at the same ambient temperature, after the instrument has been operating for the same amount of time as before.

To retrieve a former sensitivity setting, you must have made note of the following three factors during the calibration for the previous study:

1. Concentration range in which you calibrated (item 4 on screen 2.0);
2. Span percentage on screen 2.3 (also visible on screen 3.2);
3. High voltage at the concentration range in which you calibrated (screen 3.1).

In addition, mark the lamp and filters and their precise locations if you remove them. If you are readjusting the Sensitivity Adjustment Knob, for a more accurate retrieval note the time of operation and ambient temperature.

To retrieve a previous setting:

1. Install the same lamp and filters (in the same holders) in the same positions (same direction, facing the same way) as in the former study. In addition, use the same size cuvette or flow cell.
2. Allow instrument to warm up for at least 10 minutes. If the Sensitivity Knob has been adjusted, let the instrument run for the same amount of time as before at roughly the same ambient temperature.
3. Access screen 2.42 and set range to former setting.
4. Access screen 3.1 and check High Volt. If you have not readjusted the Sensitivity Adjustment Knob, it should be close to the former reading. If it matches the former reading, then go to step 5.

If it does not match, then unlock the Sensitivity Adjustment Lock using an Allen wrench. Adjust the Sensitivity Adjustment Knob slowly, pausing between adjustments until the High Voltage matches the previous setting. Then lock the Sensitivity Adjustment Lock.

5. Recalibrate your instrument following instructions in Section 3F, except that when you are running your standard on screen 2.3, **set Span to the previous percentage**. Be sure to press <\*> to save setting.

## Appendix 7 SAMPLE SYSTEM: MAINTENANCE & INSTALLATION

The sample system of the Model 10-AU-005-CE will operate with either a cuvette holder for discrete samples, or with a flow cell for continuous or on-line sampling.

The cuvette or flow cell is made of glass or quartz, depending upon the application. (See Appendix 9.)

The 25 mm Continuous-Flow Cuvette is standard with your fluorometer, unless you requested otherwise. The cuvette is made of borosilicate glass. The system has a pressure rating of 25 psig, with Intake and Exhaust Fittings of 1/2" female pipe thread.

Cuvette holders and flow cells come in various sizes. Generally, the larger the cuvette or flow cell, the lower the concentrations that can be read. Thus, for the greatest sensitivity, you would use the largest cuvette or flow cell (25 mm). To read higher concentrations, change to a smaller diameter flow cell. The shorter path length increases the linear range and reduces the effects of light-absorbing materials. (See Appendix 10; consult the Turner Designs Model 10-AU Digital Fluorometer Ordering Information booklet.)

Cuvette holders and continuous-flow cuvettes are available in the following sizes:

Cuvette Holders: 25 mm, 13 mm  
Continuous-Flow: 25 mm (One-Piece Flow Cell or 3-piece for applications where particulate material may cause clogging); 10 mm, 3 mm, or 1 mm (special order only)

Refer to the Turner Designs Model 10-AU Digital Fluorometer Ordering Information booklet for more information about specific set-ups.

### **CAUTION**

Components of the Flow Cell (Continuous-Flow Cuvette System) are made of PVC, Delrin, and/or nickel-plated brass; and the seals are made of elastomers suitable for use in freshwater and marine environments. When using the Continuous-Flow Cuvette System, DO NOT use organic solvents such as acetone, methanol, or pyridine, or corrosive materials such as strong acids and bases in the flow cell.

#### **A. Cuvette Holder Maintenance**

Generally, the only maintenance required for the Model 10-AU-005-CE cuvette holder system is to keep the sample compartment clean and dry.

**NOTE:** Insert clean test tubes or cuvettes, completely dry on the outside, and free of dirt, oil, or lint. The proper size **must be** used (i.e., 25 x 100 or 150 mm; 13 x 100 mm).

## **Model 10-AU-005-CE Fluorometer User's Manual**

Check periodically for **moisture** in the Sample Compartment. When not in use, keep the Light Cap on to keep out dirt and moisture.

**Condensation** forming on the outside of the cuvette can cause drifting readings. If there is a sufficient volume of air to pull moisture from, it can also cause erratic readings as droplets break free and run down. For this reason, keep the samples at a temperature that avoids condensation.

**NOTE:** The 10-AU-005-CE's electronics are sealed so that they are protected from damage or hazard in case of a spill inside the sample compartment. In addition, the lamp compartment is separated from the sample compartment to prevent damage to lamp components in case of a spill or leak. There is also a drain in the bottom of the cuvette holder. However, it is best to avoid spills or leaks. See subsection G, below, for the procedure to follow if water enters the Sample Compartment.

Storage. To store your fluorometer with the cuvette holder in place, open the sample compartment and make sure it is clean and dry. If you are storing it for an extended period, you might want to add a few desiccant packets (see the Turner Designs Model 10-AU Digital Fluorometer Ordering Information booklet), although it is not essential. Put the Light Cap on and tape it securely in place.

### **B. Continuous-Flow Cuvette Maintenance and Leaks**

**As long as the cuvette appears visually clean, and there is no sign of leakage, maintenance is not required. If the fluid lines leading to the system are moved or stressed, check for leaks!**

The One-Piece Flow Cell can be cleaned easily by removing the plug at the top of the flow cell and **GENTLY (avoid scratches)** brushing the inside of the glass cuvette with the flow cell brush.

If you do not have the clean-out flow cell, then the flow cell may be inspected by going through steps 1 - 4 in subsection E, below. To remove it for cleaning, drain the system, remove external connections, then continue with subsection E.

The flow cell cuvette is borosilicate glass (or quartz in some applications), and may be cleaned by normal techniques.

The O-rings are a Nitrile (Buna N) rubber. Chemical resistance is good. They must be lubricated before reassembly. See subsection F.

The Intake and Exhaust Fittings are nickel-plated brass. Do not use strong chemical cleaning agents. (See "CAUTION" previous page.)

**C. Flow Cell: Condensation and Desiccant Use**

Condensation forming on the outside of the cuvette can cause drifting readings as it builds up. If there is a sufficient volume of air to pull moisture from, it can also cause erratic readings as droplets break free and run down.

For this reason, the entire sample area is gasketed and sealed, and a space for desiccant is provided.

Usually, you won't have any problem, even without desiccant, since the free volume of air inside the sample area is small and there isn't much moisture to condense out.

If problems are encountered, proceed as follows, referring to Figure A2 (Appendix 8):

1. Remove the Sample Compartment Cover (8 hex screws).
2. Remove and discard any spent desiccant.
3. Remove the tape seal from the bottle of desiccant packages supplied with your instrument. Remove two packages, close and re-seal the bottle.
4. Place the packages in the position shown in Figure A2.
5. Re-install the Sample Compartment Cover with a minimum of delay. All 8 screws should be installed loosely - to allow best alignment. Then tighten progressively until all screws are snug, but not dead tight. (Over-tightening can cause distortion of the cover and leakage.)
6. Order a Desiccant Replacement Kit (bottle of ten), if needed.

**D. Flow Cell External Connections**

If your instrument is equipped with the 3-piece flow cell, then, as received, your instrument has both the Intake and the Exhaust Fittings installed so that their threads face forward. If it makes your plumbing job easier, either or both of these fittings may be set so they face left. See subsection F below. Intermediate positions are not available. Pull the fittings out before rotating them.

If your instrument is equipped with the One-Piece Flow Cell installed, it is ready for external connections. For installation instructions, refer to PN 998-2468 at the end of this chapter.

## **Model 10-AU-005-CE Fluorometer User's Manual**

The following points should be considered, when making external connections:

1. The 25 mm flow cell fittings accept standard 1/2" NPT male (some fittings accept female, so make a visual check) pipe threads. (See the Turner Designs Model 10-AU Digital Fluorometer Ordering Information booklet for specifications for other flow cells.) Pipe dope or the plastic tape sealers will be required.

### **CAUTION**

2. Don't over-tighten! It is possible to break the solder joint in the fittings - and also, with extreme force, you could distort the fittings to the point where the rubber-cushioned cuvette will break.

We do not recommend rigid pipe hook-up. Stress in the field may weaken connections, resulting in damage to the flow cell or leaks.

3. After you have attached plumbing connections to the 10-AU, remove the Sample Compartment cover and make sure the Upper Set Screw and the Lower Set Screw holding the flow cell in position are still tight. (DO NOT overtighten!).

### **CAUTION**

During measurements, provide a strain relief for the intake and exhaust hoses to avoid loosening these fittings.

4. Normally, you'll be going to a hose on both the Exhaust and Intake fitting. This hose must be opaque for the first several feet, at least. If not, light can "leak" in and upset your measurements.

If you have any doubts about light leakage, shade the hose, and see if the reading changes. Select the most sensitive instrument range that you plan to use.

5. If you have any question about flow cell cuvette breakage or leaks, check visually for breaks, then turn the sample system on and check for leaks. See subsection B.
6. Air bubbles will cause erratic readings. The packing gland of a pump is often a source of inward air leakage. This problem is often cured by putting the sample pump on the exhaust end of the system, so it pulls sample through rather than pushes it through.

### **CAUTION**

7. Remember that the 25 mm continuous-flow system is rated at 25 psig! If, for example, you are using a pressurized system to combat dissolved gas release, etc., be sure you do not exceed this rating.



**E. Removing the Cuvette Holder or Three-piece Flow Cell**

For the One-Piece Flow Cell, reverse the installation instructions (PN 998-2468) at the end of this Appendix.

1. Turn off the power and drain the system! If present, remove all connections from the Intake and Exhaust Fittings.
2. It is not necessary to remove the filters, however, for details about filter removal and changing, refer to Appendix 8.
3. Remove the 8 hex screws that retain the Sample Compartment Cover and pull cover toward you (Excitation Filter Holder will remain with cover). If the gasket under this cover sticks, remember that it is glued to the cover. Inserting a thin knife gently between the gasket and the Sample Compartment Casting should be sufficient.

See Figure A2 for locations of various parts with the Sample Compartment Cover removed.

4. If you have just received your instrument, the lamp will be installed. It is not necessary to remove the lamp, however, to change lamp, see Appendix 8 for instructions.



**Ultraviolet Light.** In some applications such as Rhodamine WT and Short Wavelength Oil, the light source is supplied by a clear quartz lamp, which is a source of ultraviolet light. This light can cause permanent damage to the eyes if observed. The lamp is contained in the sample compartment, which prevents any hazard during normal operation. When the sample compartment cover is removed for any reason, a safety interlock switch turns the lamp off. **DO NOT** override this safety switch. You must wear approved protective goggles whenever there is a potential for exposure to ultraviolet light from the quartz lamp. The instrument should be turned off and unplugged before removing or changing the lamp.

4. Cuvette Holder Removal
  - a. Refer to steps 1 - 4.
  - b. Using the Allen wrench, loosen the Upper Set Screw and the Lower Set Screw.
  - c. If the 10-AU-030 13 & 25 mm Cuvette Holder Set (2-piece), push the cuvette holder out through the opening in the top of the sample compartment.

**Note:** With the 10-AU-030 13 & 25 mm set, if you are simply changing from 25 mm discrete samples to 13 mm discrete samples, or vice versa, then the 13 mm holder slips inside the 25 mm holder. To ensure proper alignment, the metal pin on the top lip of the 13 mm portion fits into the groove on the top lip of the 25 mm body.

**Note:** If you are changing to the 10 mm square cuvette holder, then the 10 mm holder slips inside the 25 mm holder. To ensure proper alignment, the metal pin on the top lip of the 10 mm portion fits into the groove on the top lip of the 25 mm body.

- d. Wipe up any spilled liquids.

5. One-Piece Flow Cell Removal

Refer to installation instructions (PN 998-2468) at the end of this Appendix. Reverse the procedure.

6. Flow Cell (25 mm 3-part) Removal

- a. Refer to steps 1 - 4.
- b. Using the Allen wrench, loosen the Upper Set Screw and pull up on the Exhaust Fitting, rotating it back and forth a little, to free it. Be careful! The flow cell cuvette may come out with the Exhaust Fitting. If it does, remove it with the Exhaust Fitting. If not, pull it up and out after you have removed the Exhaust Fitting.
- c. Loosen the Lower Set Screw. Pull down on the Intake Fitting, rotating it back and forth a little, to free it.

**NOTE:** The Intake and Exhaust Fittings are identical. Don't worry about getting them mixed up.

- d. Wipe up any spilled liquids. If any old desiccant bags are in place, remove and discard them.

**F. Cuvette Holder or Flow Cell Installation**

The installation of cuvette holder or flow cell will start with the following items removed from your instrument (see subsection E):

1. Sample Compartment Cover, and 8 screws.
2. Cuvette Holder or Flow Cell

Begin with step 1 through 3, below, depending on the sample system you wish to install.

1. 10-AU-030 13 & 25 mm Cuvette Holder Set Installation; 10 mm Square Cuvette Installation

**Note:** With the cuvette holder, when taking readings, the Light Cap must cover the opening in the top of the Sample Compartment and any test tube samples to get accurate readings.

- a. Locate the larger diameter long cylinder. Note that it has an o-ring on each end to ensure a snug fit. If necessary, lubricant the o-rings with a small amount of silicone lubricant.

Orient the holder so the rounded side is facing to the left, farthest from the lamp. Insert it in the top opening of the sample compartment until the upper lip is flush with the top opening. Center the oval slits from top to bottom inside the compartment, and make sure the front face is precisely parallel to the front of the instrument. One oval slit should be precisely parallel to the lamp, and another parallel to the back of the instrument.

**CAUTION**

- b. Tighten the Lower Set Screw only so it is snug, but do not over-tighten. DO NOT TIGHTEN the Upper Set Screw; it may damage the holder. Just tighten it enough to clear the sample compartment cover and leave it loosely in place.
- c. For the 10-AU-030 13 & 25 mm holder set, to change to the 13 mm holder, simply insert the smaller diameter piece inside the larger piece, and align it by slipping the metal pin on lip of the 13 mm portion into the groove on the lip of the 25 mm portion.

**Note:** If you are changing to the 10 mm square cuvette holder, then the 10 mm holder slips inside the 25 mm holder. To ensure proper alignment, the metal pin on the top lip of the 10 mm portion fits into the groove on the top lip of the 25 mm body.

- d. Go to steps 4 - 8, below.

2. One Piece Flow Cell Installation

For the One-Piece Flow Cell, refer to installation instructions (PN 998-2468) at the end of this Appendix.

Then, go to steps 4 - 8, below.

3. Flow Cell (25 mm 3-piece) Installation

- a. Carefully inspect the two O-rings on the Exhaust Fitting and two on the Intake Fitting for nicks or tears. If there is any sign of deterioration, replace them with new O-rings, found in your Cuvette Replacement Kit. (This kit was supplied with your instrument.)

If you do replace the O-rings, order a replacement O-Ring Kit.

Be sure that the round rubber flat washers supplied on the Exhaust and Intake Fittings are in place. These flat washers are near the smaller O-rings, against the flat surface on the fittings that makes contact with the end of the cuvette.

**CAUTION**

These flat washers should be removed when the Continuous-Flow Nephelometry Kit is installed.

- b. Lubricate the O-rings. You'll find excess lubricant with the O-rings in your Cuvette Replacement Kit. Silicone oils will also do.
- c. Work the Intake Fitting up into position. The threads can face toward you, or to the left, but not at an intermediate angle. Tighten the Lower Set Screw.
- d. Carefully clean the glass or quartz cuvette. Slip it down through the hole where the Exhaust Fitting will eventually go, and press it into place on the Intake Fitting. The plastic handle of a screwdriver may be used to push the cuvette into place.
- e. Work the Exhaust Fitting down until it almost engages the cuvette. Be sure that the cuvette is properly aligned with the Exhaust Fitting. Push the Exhaust Fitting down, to engage the cuvette fully.

Note that the Exhaust Fitting may also face toward you or face to the left, but may not be at an intermediate angle.

- f. Loosen the Lower Set Screw on the Intake Fitting.

## **Appendix 7 SAMPLE SYSTEM: MAINTENANCE & INSTALLATION**

Adjust the fittings up and down until the cuvette is centered.

The ends of the cuvette should contact the flat rubber washers described in paragraph a, above, but should not compress them. (The liquid seal is supplied by the O-rings. The flat rubber washers protect the cuvette from direct contact with the metal Exhaust and Intake Fittings.)

- g. Rotate the Fittings a little as you slowly tighten the set screws - so the set screws are centered on the flats on the fittings. Wipe any fingerprints off the cuvette.

If you have any questions about leakage, now is the time to hook up the external connections, and make a visual check.

- h. Wipe up any spilled liquids. Add new desiccant, as instructed in subsection C, above.
  - i. Go to steps 4 - 8, below.
4. If the lamp was removed, reinstall it. See Appendix 8.
  5. If the Emission Filter Holder was removed, install Emission Filter Holder, and (**Important**) tighten hex screw on the end of the Holder to restore o-ring moisture-seal. (See Appendix 8.)
  6. Put the Sample Compartment cover in place (align Excitation Filter Holder carefully), and install all 8 screws very loosely.

If the Excitation Filter Holder was removed from the cover, install the Excitation Filter Holder and check alignment of Sample Compartment cover and Holder. Holder should be fully inserted with no obvious space at insertion point.

Progressively tighten all Sample Compartment screws until they are snug, but not dead tight.

**Important:** Tighten hex screw on the end of the Excitation Holder to restore o-ring moisture-seal. (See Appendix 8.)

7. If you have changed cuvette size or to a new application, you may have to readjust basic operating level using the Sensitivity Adjustment Knob. Try calibrating your instrument first following your normal procedure. (See Appendix 6B.)
8. Calibrate the fluorometer. (See Section 3F.)

**G. Water in the Sample Compartment**

If water does enter the Sample Compartment:

1. Turn power off. There is no hazard, since the lamp compartment is separated from the sample compartment, but readings will be affected.
2. Remove the Filter Holders. (See Appendix 8.)
3. Remove the Sample Compartment Cover (8 hex screws). Remove the lamp. See Figure A2 and Appendix 8.
4. If the water that entered the Sample Compartment was salt water, flush the affected area with fresh water, then with deionized or distilled water.

If only fresh water entered the Sample Compartment, flush the affected area with deionized or distilled water.

5. Check the filters for moisture or damage. Clean, dry, or replace as necessary.
6. Make sure PM tube window and lamp window are clean and free of debris (use only distilled water and a soft cloth to clean). Dry completely inside Sample Compartment with gentle heat. (A hair dryer works.)
7. Reassemble and return to service.



## **Installation of the 10-AU-020 or 10-AU-080 25mm One-Piece Flow Cell**

1. Remove the discrete sample adapter or three piece 25mm flow cell as specified in Section E of Appendix A-7 of the 10-AU User's Manual.
2. At this point, the cover should be off the lamp housing, and the excitation filter and lamp should be removed.
3. Screw in the gray valve with the red handle into the bottom of the flow cell so that it is hand tight. The assembly should look like the flow cell depicted in Figure 1. The distance between the flow cell body and the mounting plate should be about 2 1/8 inches.
4. Remove the three hex head screws from the handle mount on the flow assembly with the tool that is provided with your 10-AU fluorometer. It is kept on the 10-AU to the left of the power and signal cable connection. Remove the left half of the mounting plate.
5. Lube the two o-rings on the flow assembly with the o-ring grease provided. Insert the one-piece assembly through the hole at the bottom of the sample compartment, and slide it in half way. (See Figure 1)
6. If you have temperature compensation, attach the gray temperature compensation connector wire to the connector located underneath the sample compartment.
7. Insert the one-piece assembly the rest of the way in until it can go no further.
8. Attach the handle mount you removed in step 3 to the left handle of the 10-AU by installing the three hex head screws with the hex head tool. (See Figure 2)
9. Tighten the set screws in the sample compartment that will secure the one-piece flow cell in place.
10. Reinstall the lamp and the excitation filter that you removed in step 1 according to the instructions in Appendix A-7.
11. Install the cover plate on the lamp housing.
12. Install the silver colored pipe adapter to the top of the flow cell assembly. (See Figure 2)
13. Attach your pipe or garden hose attachments to the fluorometer. Remember: the water should flow from bottom to top on the fluorometer (i.e., the water inflow should attach to the bottom).
14. Make sure that once you are ready to flow water through the fluorometer that the red handle on the gray valve is parallel to the flow path (horizontal). If it is vertical, the flow is stopped by the valve.
15. When calibrating, turn the red handle on the valve to the vertical position and inject a standard with the syringe. You will probably have to inject two or three times to clear the previous sample entirely out of the cell. When you are done calibrating, turn the red handle to the horizontal position to resume the flow.
16. To clean the flow cell, first stop the flow of water by turning the red handle on the valve to the vertical position. Unscrew the large silver colored plug on the top of the flow assembly with a flat head screwdriver. Use a test tube brush to clear any algae or other material that may be "fouling" the cell. When you are done scrubbing the inside of the flow cell, reinstall the plug, and turn the red valve handle to the horizontal position.



# TURNER DESIGNS

845 W. Maude Avenue • Sunnyvale, CA 94086

(408) 749-0994 • FAX (408) 749-0998

Internet: <http://www.turnerdesigns.com>

## Note of Caution:

Components of the flow cell (Continuous-Flow Cuvette System) are made of PVC, Delrin, and/or nickel-plated brass; and the seals are made of elastomers suitable for use in fresh water and marine environments. When using the Continuous-Flow Cuvette System, DO NOT use organic solvents such as acetone, methanol, or pyridine, or corrosive materials such as strong acids and bases.

## One-Piece Flow Cell Drawings

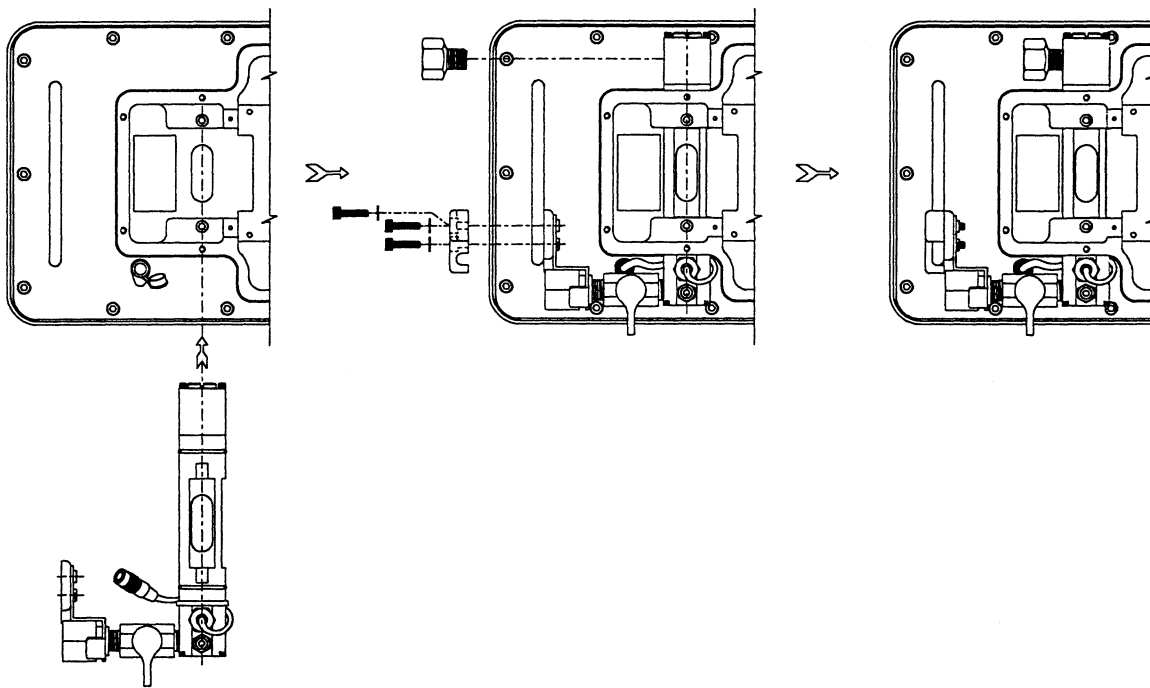

| 2 1/8 |  
Figure 1

Figure 2



## Appendix 8 FILTER AND LIGHT SOURCE REPLACEMENT

Readings on a given fluorometer are affected by the unique properties of the individual lamp and filters installed. Therefore, please note the cautionary remarks about lamps and filters when replacing them.

**NOTE:** If you change to a different cuvette size or a new lamp or filters, you will have to readjust the Sensitivity Adjustment Knob. **DO NOT ADJUST** the Sensitivity Adjustment Knob otherwise: It is not necessary and it will disrupt your study. (See Appendix 6B.)

Filters. There are three different types of filters on your fluorometer (all located inside the Sample Compartment): the reference filter, the excitation filter (mounted in a holder that fits around cuvette), and an emission filter(s). See Figure A2 for their locations. They are made of glass and will break if dropped, so handle them carefully.

Although filter problems are not common, missing, broken, or improperly mounted filters can result in erratic or unstable readings, high or low readings, or the inability to blank to zero. See Troubleshooting, Section 4B. If you are having problems that might be caused by filters, verify that you have the correct filters for your application, and that they are properly installed. (See Appendix 9 for a description of the filters needed for your application.)

Many filters are laminated (a plastic filter sandwiched between two layers of glass). With age and exposure to moisture, a filter can separate; i.e., it will no longer have a uniform color and density. To check the condition of a filter, remove it and hold it up to a bright light. Color and density should be fairly consistent; some wrinkling is acceptable. It should be replaced if it is badly separated, especially in the center portion. In the case of a mirrored filter, it should be replaced if it is flaking or freckling (look closely - freckling can be minute).

Lamp. You will be notified of a bad lamp by the "Lamp is Off/Bad" alarm. If this alarm is triggered, open the Sample Compartment and check the lamp through the viewport. But, note that it is possible for the lamp to emit a weak light, appearing to be on, and still need replacing. The lamp should be a uniform solid color over the entire length. If it is not, make sure it is properly seated on both ends. Replace the lamp if it is flickering, or only lit at one end.



**Ultraviolet Light.** In some applications such as Rhodamine WT and Short Wavelength Oil, the light source is supplied by a clear quartz lamp, which is a source of ultraviolet light. This light can cause permanent damage to the eyes if observed. The lamp is contained in the sample compartment, which prevents any hazard during normal operation. When the sample compartment cover is removed for any reason, a safety interlock switch turns the lamp off. **DO NOT** override this safety switch. You must wear approved protective goggles

## **Model 10-AU-005-CE Fluorometer User's Manual**

whenever there is a potential for exposure to ultraviolet light from the quartz lamp. The instrument should be turned off and unplugged before removing or changing the lamp.

### **Replacing the Filters and Lamp**

The 10-AU-005-CE Fluorometer is equipped with the rapid-change excitation and emission filter system. Refer to Figure 1 for the location of the filter holders. See Appendix 9 to see what filters and lamp are required for your application.

#### **Procedure:**

1. Turn off the power.
2. Filter Holders are designed with an o-ring seal against moisture in the sample compartment. The seal must be loosened before Filter Holders can be removed. Use the 5/32" Allen wrench supplied to loosen the hex nut on the end of each Filter Holder; this will break the seal and allow Holders to be removed. (See Figure A2.)
3. Grasp the Excitation Filter Holder (front) and slide it out of the instrument toward you.

The round one inch diameter filter will be held in place by a metal retainer ring or by a small hex screw (for very thick filters).

Examine the filter's condition by holding it to a bright light. Set it aside.

4. Grasp the Emission Filter Holder (to the left of the Sample Compartment) and slide it to your left and out of the instrument.

The round one-inch diameter filter will be held in place by a metal retainer ring or by a small hex screw (for very thick filters).

Examine the filter's condition by holding it to a bright light. Set it aside.

5. To install new filters already mounted in holders, simply slide the Excitation Filter Holder with the new filter and the Emission Filter Holder with the new filter into the proper slots in the Sample Compartment. The holders are labeled and designed to fit only in the proper slots in the correct orientation. We recommend that you check to see that the filter itself is correct and installed in the right holder, properly oriented before proceeding.

If you are changing applications or replacing damaged filters, see Appendix 9 to determine the proper filter(s).

## **Appendix 8 FILTER AND LIGHT SOURCE REPLACEMENT**

6. To replace the excitation filter in a holder:

- a. If the filter is held in place by a hex screw (no metal retainer ring), then use a 0.05" Allen wrench to loosen the hex screw. Place the holder back side up (with the "lip" side of the filter opening up) and push the filter out by pressing evenly on the edges of the filter with two fingers. Remember that the filter is glass and can be broken or scratched.

Locate the correct filter (Appendix 9).

**NOTE:** If an attenuator plate is necessary, install it by placing it on top of the excitation filter (closest to the lamp) before installing the retainer ring or tightening the hex nut.

If installing an interference filter (mirror-like filter set in a black ring), it must be installed with the mirrored side toward the lamp. Place the holder on a flat surface with "lip" side of the opening down. Put the filter in, mirrored-side up. Tighten the hex nut. DO NOT overtighten.

It does not matter which side of the colored glass filters faces the lamp. Place the filter in the holder opening and tighten the hex nut. DO NOT overtighten.

Wipe off any fingerprints from the filter with a lint-free wipe.

- b. If the filter is held in place by a metal retainer ring, then place the holder on a flat surface, ring side down, and push the filter out by pressing evenly on the edges of the filter with two fingers. If the filter doesn't come out with gentle pressure, try removing the metal ring first (it slides out the front of the holder). Remember that the filter is glass and can be broken or scratched.

Locate the correct filter (Appendix 9).

**NOTE:** If an attenuator plate is necessary, install it by placing it on top of the excitation filter (closest to the lamp) before installing the retainer ring or tightening the hex nut.

If installing an interference filter (mirror-like filter set in a black ring), it must be installed with the mirrored side toward the lamp. Place the holder on a flat surface with the "lip" side of the opening down. Put the filter in, mirrored-side up. Put the retainer ring on top and work it evenly into the opening until it is flat and snug against the filter.

It does not matter which side of the colored glass filters faces the lamp. Place the filter in the holder opening; put the retainer ring on top and work it evenly into the opening until it is flat and snug against the filter.

Wipe off any fingerprints from the filter with a lint-free wipe.

7. To replace the emission filter(s) in a holder:

- a. If the filter is held in place by a hex screw (no metal retainer ring), then use a 0.05" Allen wrench to loosen the hex screw. Then, place the holder with the "lip" side of the holder opening up, and push the filter out by pressing evenly on the edges of the filter with two fingers. Remember that the filter is glass and can be broken or scratched.

Locate the correct filter(s). See Appendix 9.

If using one of the interference filters (mirror-like filter set in a black ring), it must be installed with the mirrored side toward the sample. Place the holder on a flat surface with the "lip" side of the opening down. Put the filter in, mirrored-side up. Tighten the hex nut. DO NOT overtighten.

The colored glass filters must also be installed in the right direction. If the filter is a combination filter, it will have an arrow on the side; the filter will be installed so the arrow points away from the sample. Place the holder on a flat surface with the "lip" side of the holder opening down. Put the filter in so the arrow points down, toward the back side of the holder. If more than one filter is to be installed in combination, then place the filter that is to go nearest the photomultiplier in first, and the filter that is to go nearest the sample in last. Finally, tighten the hex nut. DO NOT overtighten.

Wipe off any fingerprints from the filters with a lint-free wipe.

- b. If the filter is held in place by a metal retainer ring, then place the holder on a flat surface, ring side down, and push the filter out by pressing evenly on the edges of the filter with two fingers. If the filter doesn't come out with gentle pressure, try removing the metal ring first (it slides out the front of the holder). Remember that the filter is glass and can be broken or scratched.

Locate the correct filter (Appendix 9).

If using one of the interference filters (mirror-like filter set in a black ring), it must be installed with the mirrored side toward the sample. Place the holder on a flat surface with the "lip" side of the holder opening down. Put

## Appendix 8 FILTER AND LIGHT SOURCE REPLACEMENT

the filter in, mirrored-side up. Put the retainer ring on top and work it evenly into the opening until it is flat and snug against the filter.

The colored glass filters must also be installed in the right direction. If the filter is a combination filter, it will have an arrow on the side; the filter will be installed so the arrow points away from the sample. Place the holder on a flat surface with the "lip" side of the holder opening down. Put the filter in so the arrow points down, toward the back side of the holder. If more than one filter is to be installed in combination, then place the filter that is go nearest the photomultiplier in first, and the filter that is to go nearest the sample in last. Finally, put the retainer ring on top and work it evenly into the opening until it is flat and snug against the filter.

Wipe off any fingerprints from the filters with a lint-free wipe.

8. If you have changed applications, you may have to change the lamp. Locate the Lamp for your application. (See Appendix 9.)



**Ultraviolet Light.** In some applications such as Rhodamine WT and Short Wavelength Oil, the light source is supplied by a clear quartz lamp, which is a source of ultraviolet light. This light can cause permanent damage to the eyes if observed. The lamp is contained in the sample compartment, which prevents any hazard during normal operation. When the sample compartment cover is removed for any reason, a safety interlock switch turns the lamp off. **DO NOT** override this safety switch. You must wear approved protective goggles whenever there is a potential for exposure to ultraviolet light from the quartz lamp. The instrument should be turned off and unplugged before removing or changing the lamp.

9. Remove the Sample Compartment cover by unscrewing the hex nuts retaining the cover.
10. Remove the lamp by rotating it 90 degrees and pulling it out toward you. **BE CAREFUL; IT MAY BE HOT.**

NOTE: If you are changing filters within the same application and desire to maintain calibration, you should mark the Lamp so that it may be returned to its original position.

11. Take the new lamp and install it by inserting the two end prongs into the slots on the upper and lower lamp sockets and turning 90 degrees.

If you are reinstalling the old lamp and wish to maintain calibration, the lamp should be reinstalled in the original position. See paragraph 10.

## **Model 10-AU-005-CE Fluorometer User's Manual**

12. If you are changing applications, you may have to change the reference filter. Locate the Reference Filter for your application. Refer to the Filter Selection Guide, Appendix 9, for details.

The reference filter is mounted to the right of the lamp, behind two metal spring clips. Remove the old filter by sliding it toward you from behind the two clips. Check its condition by holding it to the light.

To install the reference filter, slide it behind the two spring clips (Figure A2).

13. Replace Emission Filter Holder, and (**Important!**) tighten hex screw on the end of the Holder to restore o-ring moisture-seal. (See Appendix 8.)
14. Put the Sample Compartment cover in place and install all 8 screws loosely.

Replace the Excitation Filter Holder and check alignment of Sample Compartment cover and Holder. Holder should be fully inserted with no obvious space at insertion point.

Progressively tighten all Sample Compartment screws until they are snug, but not dead tight.

**Important:** Tighten hex screw on the end of the Excitation Holder to restore o-ring moisture-seal. (See Appendix 8.)

15. If you have changed cuvette size or to a new application, you may have to readjust basic operating level using the Sensitivity Adjustment Knob. Try calibrating your instrument first following your normal procedure.
16. Recalibrate your fluorometer. (See Section 3F.)

## Appendix 8 FILTER AND LIGHT SOURCE REPLACEMENT

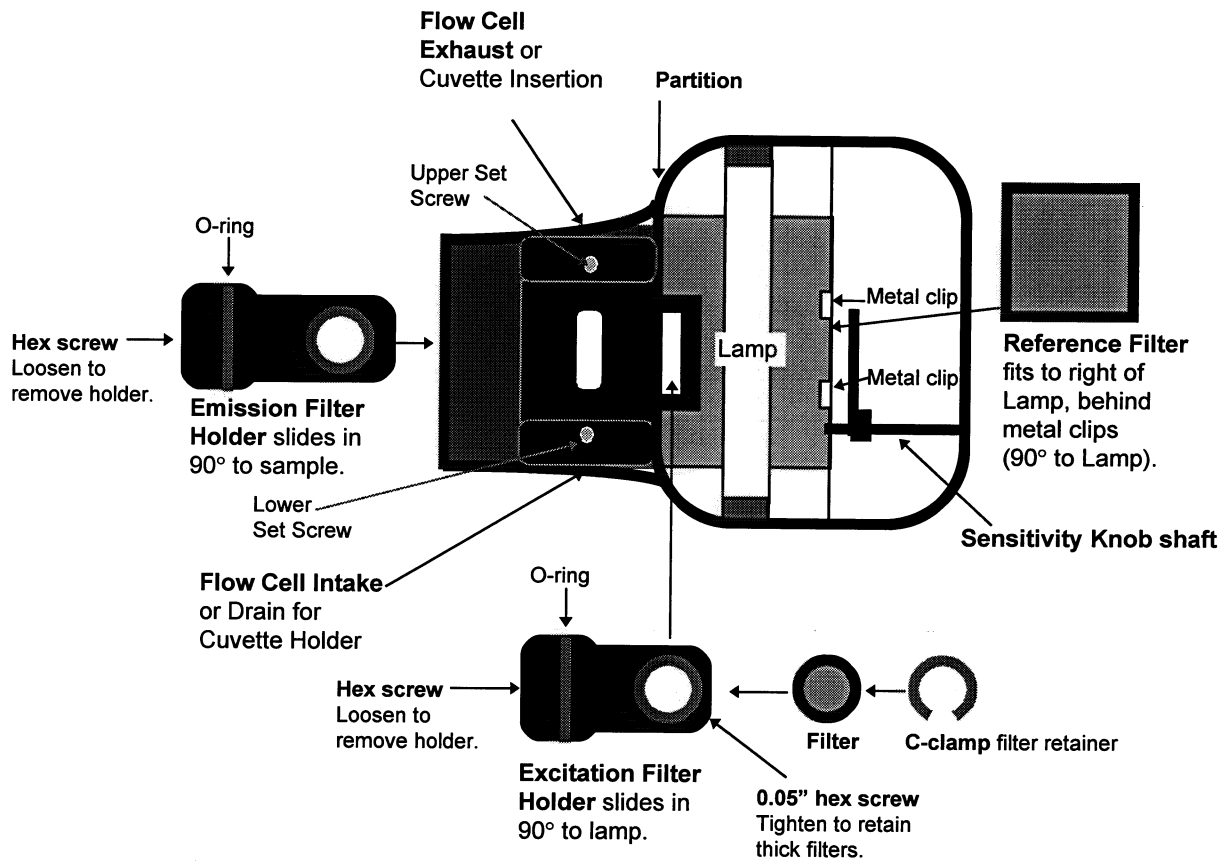

Figure A2. Sample Compartment (cover removed)

**PAGE INTENTIONALLY BLANK**



## **Appendix 9 FILTER SELECTION**

### **A. Theory of Selection**

Fluorometric analysis is based on the measurement of fluorescent materials absorbing light at one wavelength and converting it into light at a longer wavelength.

Two primary considerations in selecting the proper filter, light source, and light detector are:

1. The light source and excitation filter must allow light (which the material being analyzed absorbs at certain wavelengths) to fall on the sample.
2. The light detector and emission filter system must be sensitive to the wavelength of light emitted by the material being analyzed.

The limit of sensitivity of the Model 10-AU fluorometer is almost always determined by the level of extraneous background light that reaches the light detector. This background light may vary from sample to sample.

Four primary sources of such unwanted light and their impact on filter, light source, and light detector selection are:

1. Interference from other fluorescent material(s) in the sample.

By proper choice of the wavelength of light that falls on the sample and wavelength to which the light detector is sensitive, system sensitivity to the fluorescent material being analyzed can be maximized, while sensitivity to interfering fluorescent materials is minimized.

2. Scattered light in the system from either reflective surfaces or from turbidity.

This becomes a problem when certain inherently fluorescent filters are used. These filters convert scattered light from one wavelength to another. If the final wavelength is also transmitted by the filter, it acts as an extraneous light component and will reach the light detector.

This fluorescence of the emission filter becomes more of a problem when measuring low concentrations with high and variable turbidity. If the turbidity is constant, then it simply constitutes blank, on the assumption that it was present identically in blank, standard, and samples.

Intermediate blocking filters can reduce this interference by protecting inherently fluorescent filters from scattered light. The order of placement of these filters is important.

3. Overlap in the transmission wavelength ranges of excitation and emission filters.

If both the excitation and emission filters transmit even a small percentage of the same wavelength of light, excitation light scattered by fixed components of the sample system and turbidity in the sample can also reach the light detector. Such "overlap" should be held to a minimum.

4. Raman fluorescence of the solvent.

This interference, which is often significant, can be minimized by proper selection of filters that prevent the Raman fluorescence from reaching the light detector.

Raman will not vary from sample to sample. It will contribute to an increased blank, which does add noise when reading low concentrations.



## OPTICAL FILTERS

Turner Designs fluorometers require an excitation and an emission filter; the Model 10-AU also uses a reference filter. Optical filters are chosen to be optimal for each application, cost effective, and durable. Filters are used to selectively pass a portion of the ultraviolet or visible spectrum.

In combination with a light source, the excitation filter allows only light which excites the molecule of interest to strike the sample. The emission filter allows the fluorescence from the sample to pass to the detector and blocks stray light from the light source or interfering components in the sample. The reference filter is used in the reference path of the 10-AU series and is a factor in determining the basic operating level of the instrument.

Filters can be used alone or in combination to select the desired spectral band. Optical filters obey the Bouguer-Lambert Law, which states that the spectral transmittance of two or more optical filters used simultaneously is equal to the product of the spectral transmittance of each filter.<sup>1</sup>

Filters with four types of spectral characteristics are used in Turner Designs fluorometers: broadband, narrowband, sharpcut, and neutral density.

- A **broadband** filter can pass a broad band of light. For instance, a broadband filter may transmit light from 300 - 400 nm, but block light with wavelengths shorter than 300 and longer than 400.
- **Narrowband** filters pass a narrow band of light (as little as 1 nm). For example, a 436 nm filter with a bandpass of 10 nm, will pass light from 431 - 441 nm (5 nm on either side of 436 nm).
- **Sharpcut** or edge filters can be used to block light that is longer or shorter than a nominal wavelength. A 450 nm long-wave filter will allow transmission of light that is longer than 450 nm, but it will block light that is shorter than 450 nm. A 450 nm short-wave filter will transmit light that is shorter than 450 nm and block light that is longer than 450 nm.
- A **neutral density** filter, primarily used as a reference filter, can be used to decrease the transmitted light across a very broad spectrum. For instance, a neutral density filter can be used to decrease the total light transmission by a factor of 10 or 100.

Three types of optical filters are used in Turner Designs Fluorometers: 1. Optical Glass, 2. Interference, and 3. Gel Wratten.

1. **Optical Glass Filters.** Optical glass filters are made from glass that absorbs specific wavelengths of the spectrum. They are relatively inexpensive and are very durable under most conditions. Both bandpass, sharpcut, and neutral density filters are available in optical glass. However, the choice of filter glasses is limited. The amount of transmission and band width is dependent on the glass thickness. The following factors may affect optical glass:

- Thermal shock caused by a rapid temperature change;
- Solarization caused by prolonged exposure to ultraviolet light can cause an increase in absorption (decrease in transmission);
- Exposure to high humidity or corrosive environments can cause 'spotting' or 'staining', which changes the surface, resulting in increased light scattering off the surface and decreased transmission through the glass.<sup>2</sup>

However, we have found that glass filters can be used for years or decades under most conditions.

- Interference Filters.** In terms of spectral characteristics, interference filters can have broad or narrow bandpasses, or can be sharpcut filters. Interference filters used in Turner Designs fluorometers are primarily narrow bandpass. Interference filters are made by coating optical glass with two thin films of reflecting material separated by an even-order spacer layer. The central wavelength and bandwidth of the filter can be controlled by varying the thickness of the spacer layer and/or the number of reflecting layers. To ensure out-of-band blocking — blocking undesirable wavelengths of light — an additional blocking component is added. While the additional blocking eliminates out-of-band light transmission and decreases background noise, it also decreases the overall light transmission through the filter which decreases the fluorescent signal. Interference filters typically permit 10 to 70% light transmission. The minimum specified transmission depends on the transmitted wavelength and bandwidth.

Interference filters are affected by temperature. The center wavelength will shift linearly with, and in the direction of, changes in temperature. For example, the temperature coefficient for a 400 nm filter is about 0.015 nm/°C. The center wavelength and maximum transmission of interference filters can drift with age, especially under conditions of high humidity and variable temperatures.<sup>3</sup> Good quality filters are hermetically-sealed to mitigate the affects of aging. Hermetically sealed filters are guaranteed for one year; we have found that under good ambient conditions, such as in a laboratory, the filters show minimum signs of aging after two years or more.

A new interference filter usually has a uniformly dark side and a uniformly reflective or mirrored side. To protect the filter from heat and light, the reflective side should always face the light source. A filter that is affected by age and humidity will show discoloration around the outside diameter, this discoloration will move toward the center of the filter with time and additional damage. A symptom of aging is a significantly decreased maximum transmission which results in less sensitivity for a fluorescent assay. The recommended operating conditions for interference filters is -40°C to +70°C, and a maximum temperature change of 5°C/minute.<sup>3</sup>

- Gel Wratten Filters.** Gel Wratten filters can have broad or narrow bandpasses or can be sharpcut filters. Gelatin filters are made by dissolving specific organic dyes into liquid gelatin. The gelatin is coated onto prepared glass and when it is dry, it is stripped off the glass and coated with lacquer. Each filter is standardized for spectral transmittance and total transmittance. At Turner Designs, the gelatin filter is placed between two pieces of glass or in combination with other filters for use in the fluorometer. Like dyes in other applications, the spectral characteristics of the dyes used in filters may change depending on the dye used, age, and exposure to heat and light. Gelatin filters should be kept cool, dry and should not be subjected to temperatures higher than 50°C.<sup>1</sup> Most of the gelatin filters used by Turner Designs have been found to be stable under test conditions, which include up to two weeks of continuous exposure to several light sources.

## References

<sup>1</sup> Kodak Filters for Scientific and Technical Uses, Eastman Kodak Company, 3 ed. 1981.

<sup>2</sup> Schott Color Filter Glass, Schott Optical Glass Inc., 1976

<sup>3</sup> Andover Corporation Optical Filter Guide, Andover Corporation.

## Appendix 10 MODEL 10-AU FLUOROMETER SENSITIVITY

Note that the sensitivity limits set forth below are **estimations only**. In most cases, using a different cuvette size in combination with selected filters will permit measurements of concentrations satisfactory for your study. Contact Turner Designs to discuss special cases.

### A. Oil Measurements.

The aromatic hydrocarbons in petroleum and petroleum by-products are naturally fluorescent. See Appendix 3 for more information on types of oil studies.

25 x 150 mm Cuvette Holder or Continuous-flow Cuvette. Using the short wavelength oil optical kit, with no sample treatment, concentrations of crude or very heavy oils have been detected on a continuous-flow basis in sea water as low as 5 parts per billion (ppb). Extractive techniques allow detection at even lower concentrations: detectability at 0.2 ppb has been reported. Using the long wavelength optical kit, the limit of detectability is about 0.1 ppm; the linear range extends to about 50 ppm; and the useful range using a calibration curve extends to about 200 ppm.

Concentrations of #2 fuel or lighter oils have been detected using the short wavelength oil filters at about 2 ppb; the linear range extends to about 2 ppm; and the useful range using a calibration curve is about 10 ppm.

Recently, we have measured gasoline and benzene as low as 15 ppb, and are currently studying ways to further increase sensitivity.

13 x 100 mm Cuvette Holder or Continuous-flow Cuvette. Sensitivity is approximately 20% of that of the 25 mm. The shorter path length allows higher concentrations to be read, with an increase in the linear range.

3 mm Continuous-flow Cuvette. This flow cell allows measurements at even higher concentrations than the intermediate size. The shorter path length increases the linear range and reduces the effects of light-absorbing materials. We have read processing and cutting oils linear to 1000 ppm, and using a calibration curve in the parts per thousand range.

1 mm Continuous-flow Cuvette. We have measured crude oil linear to 250 ppm, with the useful range using a calibration curve as high as 1000 ppm.

## **B. Chlorophyll and Pheophytin.**

All chlorophyll-containing organisms are fluorescent. Where the organisms are small, such as phytoplankton, fluorescence may be measured directly without extraction or chemical treatment. Sensitivity of the fluorometer varies, depending upon such factors as the amount of organic substance associated with a given quantity of plant pigment, the presence of humic materials, and the fluorescence efficiency of the particular species. However, the fluorometer is at least 20 times more sensitive than spectrophotometric techniques.

Continuous-flow Cuvette. *In vivo* measurements are commonly used at open-ocean levels, with either the 13 mm or 25 mm flow cell. The fluorescence of chlorophyll in intact cells exhibits about one-tenth (0.1) the intensity of acetone extracts (Lorenzen, Carl J., "A Method for the Continuous Measurement of *In Vivo* Chlorophyll Concentration," *Deep-Sea Research* 13:223-227 (1966).

Cuvette Holder. The 13 mm Cuvette Holder is normally used with extractive techniques. The limit of detectability is about 25 parts per trillion in the final extract. With the 25 mm Cuvette Holder, sensitivity would be increased about 5-fold (5 parts per trillion).

The US Environmental Protection Agency has authored a new standard method for extracted chlorophyll. Method 445.0 found detection limits of .05 µg/L (ppb; or 50 parts per trillion); the upper limit of linearity was 250 µg/L. Contact Turner Designs for Method 445.0, "*In Vitro* Determination of Chlorophyll *a* and Pheophytin *a* in Marine and Freshwater Phytoplankton by Fluorescence."

For information about linearity and factors affecting measurements, ask for our monograph "Chlorophyll and Pheophytin."

3 mm Continuous-flow Cuvette. Allows measurements at higher concentrations than the intermediate size. The shorter path length increases the linear range and reduces the effects of light-absorbing materials. (Contact Turner Designs for details.)

## **C. Fluorescent Tracer Studies.**

25 x 150 mm Cuvette or Flow Cell. The limit of detectability in pure water of the most commonly used fluorescent dyes (Rhodamine WT, Rhodamine B, and fluorescein) is about 10 parts per trillion. Pontacyl brilliant pink is less detectable by a factor of three. The linear range extends to about 0.1 ppm (active ingredient); and the useful range using a calibration curve is 0.5 ppm. Factors such as fluorescent background affect the detectability. In raw sewage, however, measurements can be made to 0.1 ppb of Rhodamine WT. Refer to Appendix 3 for more information on fluorescent tracer studies.

## Appendix 11 DATA COLLECTION

### A. External Data Logging

The Model 10-AU-005-CE is configured to output both voltage (analog) and serial signals to external data collection devices. The voltage output parameters appear on screen 1.4, and the serial data output parameters appear on screen 1.5. They are displayed on the Model 10-AU-005-CE even if you are not connected to an external device. They are operational only in conjunction with an external data collection device connected to the 10-AU through the AC or DC Power & Signal Cable.

The voltage and serial signals can be used simultaneously. For example, voltage output could be sent to a chart recorder at the same time serial output was being sent to a computer.

Refer to Table 6 for default values and ranges for these parameters.

To log data with the 10-AU using Windows®, contact Turner Designs for information about the 10-AU-005-CE Fluorometer Spreadsheet Interface Software (P/N 10-AU-4400). (See Appendix 11, section B.)

#### 1. Screen 1.4: Output (Voltage Output)

- 1.41 Full scale voltage
- 1.42 Zero point
- 1.43 Full scale

To access screen 1.4, from the Main Menu, press <1>, Operational Parameters, then press <4>.

The voltage output can be sent to a chart recorder or data logger. The output is proportional to the reading on the HOME screen; it is continuous and updated once every second.

**NOTE:** If the Model 10-AU is in the auto-range mode, when it changes ranges the readout on the HOME screen and the voltage output will "freeze" for 5 seconds. During this 5 seconds, this "frozen" output is what will be sent to a chart recorder or data logger.

- a. Full scale voltage. The user can set 0.1, 1, 2, or 5 V as full scale. This allows flexibility in connecting to different data loggers or chart recorders.

- b. Zero point. The user can select what sample concentration will correspond to the output zero point and the output full scale. For example, the user could assign 100 ppm to zero and 900 ppm to full scale. The narrower the range, the greater the resolution. However, if, for example, zero volts is set to correspond to 40 and 5 volts (full scale) to 60, then any reading below 40 would be output as zero, and any data above 60 would be output as greater than 5, with a maximum of 5.12 volts.
- c. Full scale. The user can select what sample concentration will correspond to the output full scale. See the example in paragraph b.

2. Screen 1.5: Serial Data Out

- 1.51 Baud rate
- 1.52 Set interval
- 1.53 Set index
- 1.54 Set format\*

\* visible only if the optional temperature-correction package has been purchased and the temperature probe is plugged into the instrument

The serial output signal can be sent to a computer or serial logger or printer. Serial data is sent out in seven significant figures (XXXX.XXX). The data sent out are the sample readings from the HOME screen (except readings will be in seven, rather than three, significant figures).

When used in conjunction with a computer, serial data is sent out in real-time, on the selected interval, and displayed on the computer with the index number, the date, time, and concentration readout or relative fluorescence.

**NOTE:** If the 10-AU is in the auto-range mode, when it changes ranges, the readout on the HOME screen will "freeze" for 5 seconds. During this 5-second period, the "frozen" reading is the one that will be sent to any data collection device.

Detailed instructions for using the 10-AU in conjunction with a computer are found in Appendix 11B.



## **Appendix 11 DATA COLLECTION**

To access screen 1.5, from the Main Menu, press <1>, Operational Parameters, then press <5>.

- a. Baud rate. Allows the user to select either 9600 or 4800 baud rate, as compatible with your computer.
- b. Set interval. The user can determine how often data will be sent out to a computer or logger, from 0 to 3600 seconds.

There is an additional feature, a Manual Serial Data Output, which allows you to output a reading to the computer any time, simply by pressing 1 - 8 on the keypad, while on the HOME screen. For example, if you have selected a 10-second interval, the 10-AU will output a reading to the computer every 10 seconds. From the HOME screen, if you press <2> during the 10-second interval, on the keypress, a reading will be sent to the computer with the marker "2" displayed in front of the index number for that reading.

- c. Set index. The user may select a number from 0 - 9999 to begin numbering a set of data. For example, if you select an index of 100, with an interval of 10 seconds, and begin logging, after 10 seconds the first reading will be sent to the computer with an index number of 0100; in another 10 seconds the second reading will be sent, numbered 0101, etc. When 9999 is reached, the index will return to 0.
- d. Set format. The user may decide to send out "data only" or "data plus temperature" to a computer or data logger. (This function will appear only if you have purchased the optional temperature-compensation package and the temperature probe is plugged into the instrument.)

**Table 6. External Data Logging Defaults and Ranges**

<u>Data Logging Parameter</u>	<u>Default</u>	<u>Range</u>
Output full scale voltage	2V	0.1, 1, 2, 5 V
Output zero point	0	0 - 9998
Output full scale	999	1 - 9999
RS-232 baud rate	9600	9600/4800
Serial data out interval	5 (SEC)	0 - 3600 (SEC)
Serial data out index	0	0 - 9999
Serial data out format*	Data only	Data only/data+temp

\* Visible only if equipped with the optional temperature-correction package, and temperature probe is plugged in

**3. Serial Data Output Information for Programmers.**

(See Appendix 11H for Power/Telemetry Connector pin inputs and outputs.)

If you plan to interface your 10-AU with other instruments and need to write a program to do so, a definition of the serial data output string follows. If you are using the Turner Designs Data Collection Software (see Appendix 10B), you do not need to review this subsection.

**Serial Data Protocol:** RS-232 asynchronous; 4800/9600 baud; 8 data bits; 1 stop bit; no parity check.

Here are three sample lines of data sent out from the fluorometer (100% ASCII):

```

0  0013  ::  4/23/92  21:34:25  =  55.429  (mg/kg)  83.4  (F)
0  0014  ::  10/23/92  11:02:07  =  10.009  (PPM)   27.8  (C)
0  0015  ::  4/23/92  09:18:31  =  40.223  (mg/l)  44.4  (F)
↑↑↑    ↑  ↑          ↑          ↑  ↑          ↑    ↑↑↑    ↑
                               or↑↑    or↑↑↑↑
    
```

## Appendix 11 DATA COLLECTION

Each line starts with ASCII 0X0D (carrier return) and ASCII 0X0A (linefeed), and:

0	= Marker (0 to 8)
0013	= 4-digit index (0000 to 9999)
::	= Separator (2 ASCII 0X3A)
4/23/92	= Month/Date/Year
21:34:25	= Hour:Min:Sec
=	= Separator (ASCII 0X3D)
55.429	= Signal (Maximum 7 digits: XXXX.XXX)
(mg/kg)	= Signal units of measurement
83.4	= Temperature (to one decimal)*
(F)	= Temperature nomenclature*
(blank)	= No terminator
	* if equipped with temperature compensation
↑	= Arrows indicate the number of spaces between data items.

There may be one or two spaces (indicated by ↑) after the signal, depending on the signal units of measurement you choose. If you choose (RAW) or (PPM) or another three-character unit, then there will be two spaces. If you choose units with more than three characters (for example, mg/l), then there will only be one space. After the units, there may be two or three spaces, depending on the units chosen. If you choose units with five characters (i.e., mg/kg), then there will be two spaces. For three or four character units (i.e., PPB or mg/l) there will be three spaces.

**Example.** If you wanted program your computer so just the signal, the units, and the temperature were captured, you would look for the equal sign. One space after the equal sign the signal begins; it ends with a space. After the space (or spaces), look for a parenthesis "("; the units of measurement begin with "(" and end with ")". After the ")", look for two or three spaces, then the temperature readout begins; temperature ends with a space. The temperature nomenclature (F or C) is then found between the last "(" and ")".

**B. Spreadsheet Interface Software (used with external data logging)**

The Spreadsheet Interface Software (P/N 10-AU-4400) was written by Turner Designs to allow discrete sampling data or continuous flow cell data from the fluorometer to be sent directly to an Excel® spreadsheet. The data can either be sent manually to the spreadsheet or at a programmed rate ranging from 0-3600 seconds (see section A2 of Appendix 11). Please contact Turner Designs for more information.

**Note:** If you are using a DOS-based system, contact Turner Designs about the Data Collection Software (DCS) program, a DOS-based system written specifically to interface with the fluorometer's external data logging capability. Using DCS, data will be sent in real-time directly to an external computer (IBM-compatible). Data includes a marker, index, date, time, sample readout (to seven significant digits), and temperature if your fluorometer is equipped with temperature compensation. The amount of data you can log is limited only by the disk memory of your computer. DCS saves data in ASCII format for manipulation with standard computer programs.

**C. Serial Data Collection with a Macintosh Computer**

The serial data output function on Turner Designs' instruments is fully compatible with a Macintosh computer. Turner Designs instruments send out an ASCII signal, which is readable by most standard Macintosh-compatible programs.

You will need the appropriate cables and adapter to establish the connection. If you do not already have the required cables, Turner Designs offers a Macintosh Cable Kit (P/N 7000-940).

Refer to Turner Designs operation manual for instructions about data output settings on instrument.

**Data Capture Using a Macintosh Desktop Computer**

1. Connect your computer to the RS-232 port on the instrument with the cables included in the kit. (computer ⇒ round 8 pin-25 pin cable ⇒ 25 pin/9 pin adapter ⇒ RS-232 cable (came with instrument) ⇒ instrument).
2. Access **File** (from toolbar) ⇒ Create a **New Folder** in which the data can be stored.
3. On your computer, open the communications program you have chosen to use (Z modem, Z-term, Microphone II, Clarisworks, any terminal program, etc.). For details on operating your communications program, refer to program manual.

**NOTE:** If there is no appropriate communications software on your computer you can download Z-modem from most shareware sites on the Internet.

If all communication settings are already set up on the instrument and computer, data will appear on the screen and you can skip steps 4 and 5.

4. Depending and which model you have, either; access **apple menu** ⇒ **control panels** ⇒ **communications** (or) access **settings**(from toolbar) ⇒ **connection**.
5. Once in **communications/connection**, set **baud rate** = 9600, **data bits** = 8, **stop bits** = 1.
6. When you are ready to begin measurements, access **File** (from toolbar) ⇒ **Start Capture**, when asked where to send data, choose the **new folder** you created in Step 1.

## **Model 10-AU-005-CE Fluorometer User's Manual**

7. Set your fluorometer for real time serial data logging. If you want to log data continuously, select an interval from 1 - 3600 seconds on screen 1.52. If you want to log discrete data, set the interval to 0 on screen 1.52. Then, when you want to log a data point, press a number <1> through <8> on the fluorometer keypad. Data should appear on computer screen.

Example: To log discrete sample readings, press any number <1> through <8> from the HOME screen. A row of data will be sent to your computer, e.g.:

```
1 1242 :: 6/07/93 17:03:57 = 25.789 (PPM) 26.2 (C)
```

Each time you wish to log a sample reading, press a number <1> through <8> on the fluorometer keypad.

8. When data transfer is complete, access File (from toolbar) and select **Stop Capture**. The active window will continue to display downloading data. To exit, access **File** ⇒ choose **Quit**. To view data, access the folder that was made in Step 1. From this folder the data can be moved to a spreadsheet program through the **transfer** function or through **cut and paste** functions.

## **Data Capture Using a Macintosh Laptop Computer**

Because laptop computers have only one serial port, establishing a connection with a Turner Designs instrument can be a more complex process compared to use of a desktop. However, once the connection has been established and setup noted, the process is identical to the desktop procedure.

When starting computer, hold down the **Shift** key to turn off all extensions. This will free up any programs that could be occupying the serial port. However, some of the extensions may be needed for data transfer and therefore each laptop user must go through a process of trial and error to find the essential extensions.

**(NOTE: Every computer varies in extensions and therefore must be handled on a case by case basis)**

Once the computer is booted up with extensions off, follow desktop instructions 1-5.

If no data appears in window:

1. Access **apple menu** ⇒ **control panels** ⇒ **extensions manager**
2. Once in **extensions manager**, you must check various extensions that may affect the serial port connection and restart computer with chosen extensions to determine if data transfer is initiated (examples: **apple share**, **apple modem**, **serial arbitrator**, and other serial devices). **NOTE: When you restart computer DO NOT hold down shift key, so chosen extensions will be activated.**

**NOTE: Examples of extensions that will not affect serial port connections include; quick time, apple guide, printers, etc.). Also, the apple talk program must be disabled to establish a connection. To do this, apple menu⇒ chooser⇒ apple talk⇒ disable.**

3. Once data transfer is established, save settings or note which extensions are on/off for ease in future data collection.

**D. Internal Data Logging**

Internal data logging is an optional feature on your Model 10-AU-005-CE. The internal data logger permits the user to record the measured sample concentration or raw data, the sample temperature, date, and time.

The sample reading is recorded as displayed on the HOME screen (3 digits). If the reading exceeds 999, the maximum for the HOME screen, then 999 will be recorded. If the reading falls below -999, the minimum for the HOME screen, then -999 will be recorded.

**NOTE:** If the Model 10-AU is in the auto-range mode, when it changes ranges, the readout on the HOME screen will "freeze" for 5 seconds. During this 5-second period, the "frozen" reading is the one that will be sent to the internal data logger.

If the sample temperature drops below 0°C, then "0" will be recorded (32°F). Sample temperature above 96°C (204.8°F) will be recorded as 96°C (204.8°F). Temperature will be recorded to 1 decimal: XXX.X.

The user can log up to 64,800 data points (index; date and time if applicable; sample reading; temperature if applicable):

<u>Logging Strategy</u>	<u>No. Data Points</u>
Cycle w/ temperature	18,510
Cycle w/o temperature	21,600
One Way w/temperature	43,200
One Way w/o temperature	64,800

Depending on the data logging parameters chosen, the user can log from 5.14 hours (if the interval is once a second) to 1350 days (if the interval is once every 30 minutes) before the memory is full. The factors affecting the amount of data logging time available are the strategy, the interval, and whether or not temperature is logged.

Data is retrieved by a PC through the RS-232 serial port (DB9 Female) using the fluorometer Internal Data Logger Data Output Program (IDL) provided. Using IDL, data can be converted to an ASCII format file, which can be exported to a spreadsheet program or a word processing program for manipulation.



**Electronic Chart Recording** is an optional feature for the internal data logger. With this feature, you can view data logged by the internal data logger on the fluorometer display without having to download it to a computer, or you can download a screen of data (240 data points) as a separate file.

If your fluorometer is equipped with internal data logging, parameters may be accessed by pressing <5> on the Main Menu. Refer to Table 7 for default values and ranges.

1. Screen 5.0: Internal Data Logger

- 5.1 View data++
- 5.2 Logging configuration
- 5.3 Status
  - Data set no. (out of 48 sets)+
  - Percentage of memory left:+
- 5.4 Download data to computer
- 5.5 Erase data from memory

- + Visible only if "One Way" strategy selected
- ++ Visible only with Electronic Chart Recording

Definitions:

- a. View data. If you have the optional Electronic Chart Recording capability, pressing <1> from screen 5.0, accesses screen 5.1:

```
=====
Strategy:
Data set no.:+
Method:                Interval:+
Sig. unit: (PPM)       Log temp.:
Starting:+   Date      Time
Ending:      Date      Time
Press <ENT> for next data set+
Press <*> to see chart                                     #5.1
=====
+   Visible only if "One Way" logging strategy selected
```

This screen provides information about internal data logging parameters. If you are logging in the "ONE WAY" strategy, you can view the parameters for the different sets one by one by pressing <ENT>. The information displayed for the One Way strategy is for the set displayed under "Data set no.", not the set currently being logged.

**Electronic Chart Recording (ECR).** If your fluorometer is equipped with this optional feature, pressing <\*> on screen 5.1 will allow you to view data logged by the internal data logger. To access the ECR, first access screen 5.3 and set data logging status to "Stop." Then, from screen 5.1, press <\*>. A screen will appear, showing a data point graph:

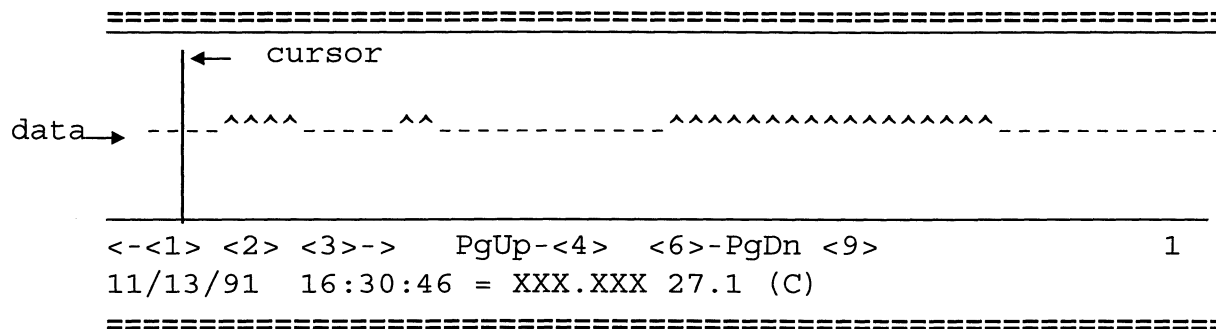

**ECR Commands.** The bottom line on the screen indicates the date, time, sample reading, and temperature for the data point where the cursor is presently located. There are 240 data points possible for each screen. In the Cycle strategy, if the memory is full, data will fill 78 pages (90 pages if temperature is not logged); in the One Way strategy, if the memory is full, data will fill 180 pages (270 pages if temperature is not logged). The current page number is displayed in the lower right hand corner.

Press <1> to move the cursor to the left, one data point at a time. (The cursor will wrap at the beginning of the page.)

Press <2> to move the cursor to the right, 20 data points at a time. (The cursor will wrap at the end of the page.) This function acts like the tab function in a word processing program; i.e., the movement is a fixed distance of 20 points, and it may not move 20 points if you have pressed <1> or <3>.

Press <3> to move the cursor to the right one data point at a time. (The cursor will wrap at the end of the page.)

Press <4> to go to a previous page of data.

Press <6> to advance to the next page of data. "LAST PAGE" will be displayed when the last page of data is reached.

Press <9> to send the data on the page currently displayed to an external computer. If you wish to examine a portion of the

data further, you can download a selected page of the data (240 data points) to a separate file using the IDL program. (See Appendix 11F & G, below.)

Setting ECR zero and full scale points. The analog Output zero and full scale points, accessed from screen 1.4 (items 2 and 3), may be used to define the zero and full scale levels when viewing the data. For example, say the sample readouts have been ranging from 40 to 60 ppm. You could set the Output zero point to 30 on screen 1.42, and the Output full scale to 70 on screen 1.43, thus obtaining greater resolution when viewing the data.

Keep in mind that the analog outputs in this case are for viewing the data only; they have nothing to do with the internal data logger's storage of the data. They will, however, determine the zero and full scale points if you are using a regular chart recorder or other analog device; therefore, be sure to reset them before starting any analog recorder.

b. Logging configuration. From screen 5.2, you can access the following parameters:

1. Interval. The user can determine how often data will be logged into the Model 10-AU memory, from once a second to every 30 minutes.

Total data logging time. This item appears on screens 5.2 and 5.21. It is the length of time the system will log data (with the chosen interval and options) before the memory is full. For example, if you choose a 5-second interval (in the One Way logging strategy, without logging temperature), you can log data for 90 hours before the memory is full; if you choose a 10-minute interval, you have 450 days.

Total data logging time is actual time, not time remaining. The user-settable options that affect the logging time are: logging strategy (see subsection 3 below); data logging interval; and whether or not temperature is to be logged (see subsection 4 below).

2. Method. On screen 5.22, the user can choose either "instant" or "average". If "instant" is chosen, then data will be saved at the precise moment of the data logging interval. If "average" is selected, the data will be averaged over the past data

logging interval, and the average will be saved. For example, if 10 seconds is the data logging interval, on the "instant" setting, the reading at every 10-second mark will be saved. If "average" is selected, the reading saved at the 10-second mark will be the average of the readings in the last 10-second interval.

3. Strategy. On screen 5.23, the user can choose either "One Way" or "Cycle". One Way and Cycle are different data logging structures, so you cannot change from one to the other once data logging is started until data is erased.

One Way. If One Way is chosen, the data will be saved in chronological order until the memory is full, then no more data will be written. A "set" of data is created each time data logging is started and stopped, with a maximum of 48 sets available. The number of sets does not change the amount of logging time available: i.e., if you have 18 hours of memory and you start logging at hour 1 and do not stop until hour 18 is over, you have used one set, but all of the memory. If you started logging at hour 1 and stopped after hour 10, started again the next day with hour 11 and stopped at the end of hour 15, you would have used 2 sets of data and 15 hours of memory. If the memory is full and you select "logging" on screen 5.3, logging status will remain at "Stop."

Cycle. If Cycle is selected, data will be saved in chronological order until the memory is full, then the most current data will write over the old data, starting with the oldest data. Cycle uses more memory than One Way because of the need for a date and time stamp for each reading.

4. Log temperature. This item will be displayed only if the optional temperature-correction package has been purchased, and the temperature probe is in place. If so, the user can choose whether or not to save temperature data on screen 5.24. If you choose to save temperature data, it will be saved at the same interval as chosen for sample data.
- c. Status. The user starts and stops data logging on screen 5.3, by selecting "stop" or "logging". If data is logging, you will not be able to change the system clock (item 4 on the Main Menu) when using the One Way logging strategy; or change the logging method (screen 5.22) or logging strategy (screen 5.23); or download to a computer (item 4, screen 5.0); or erase data (item 5, screen 5.0); or change

the units of measurement (item 2, screen 1.0); or change the readout (direct vs. raw on screen 1.21). This prevents errors in data collection.

If data is logging in the Cycle strategy, the instrument will allow you to reset the system clock, although this will disrupt the continuity of date and time.

During calibration, if data is being logged, it will continue, but some data points will be nonsense. Therefore, data logging should be stopped before calibrating.

In the logging mode, "LOGGING DATA" will flash on the HOME screen under the sample reading.

If data logging is interrupted because of a power failure, data logging will resume when power is restored.

It is recommended that data logging be stopped (screen 5.3) before power to the fluorometer is shut off or disconnected. There is a very slight chance that data may be corrupted if power is interrupted while the instrument is saving data into memory.

- d. Download data to a computer. From screen 5.4, you can download the stored data to a computer. The RS-232 cable must be connected to the computer and the computer's data collection program running, with menu item 4 or 6 selected. Then, press <8> five times to start downloading data.

Note that to avoid loss of data, you will not be able to access screen 5.4 to download data when the fluorometer is in the logging mode (access screen 5.3 to stop or start data logging).

Depending on the speed of your computer, it may take several minutes to download all data, especially if the memory is full. If downloading is interrupted before completed because of a power failure or other situation, restart the downloading procedure again. You may download data as many times as you want until it is erased.

- e. Erase data from memory. From screen 5.5, you can erase all data from the memory. BE SURE that you have downloaded the data to a computer first (see screen 5.4). If you are sure you want to erase the data, press <9> five times. Erasure will be nearly instantaneous.

Note that to avoid loss of data, you will not be able to access screen 5.5 to erase data when the fluorometer is in the logging mode (access screen 5.3 to stop or start data logging).

**Table 7. Internal Data Logging Defaults and Ranges**

<u>Data Logging Parameter</u>	<u>Default</u>	<u>Range</u>
Data logging interval	3 (SEC)	1, 2, 3, 5, 10, 20, 30 seconds; 1, 2, 3, 5, 10, 20, 30 minutes
Total data logging time	54 (HRs)	Varies from 5 hours to 1350 days, depending on the logging options selected.
Logging Status	Stop	Stop/logging
Data set no.+	0	0 - 48
Percentage of memory left+	100%	0 - 100%
Logging method	Instant	Instant/Average
Logging strategy	One Way	One Way/Cycle
Log temperature*	No	No/Yes

+ visible only if One Way strategy selected

\* Visible only if the optional temperature-correction package has been purchased and temperature probe is plugged into the instrument

**E. Using the Fluorometer Internal Data Logger Output Program (Version 1B)**

The Internal Data Logger Output (IDL) is a DOS-based program written specifically to interface with the fluorometer's internal data logger. Using the program, data can be downloaded to a computer and converted to ASCII format for manipulation with standard computer programs.

Place the disk containing the IDL program in your computer.

**NOTE:** If the fluorometer's internal data logger memory is full, you should copy the program onto your hard disk in order to have enough memory to download and convert the data.

At the DOS prompt, load the program by typing "IDL\_1B," then <ENT>. The MAIN MENU (Version 1B) will appear on your screen:

```
=====
                          MAIN MENU

1.  Modify Serial Port Setup
2.  Go to DOS
3.  List directory
4.  Download Data from Instrument to File
5.  Convert Downloaded Data File to ASCII File
6.  Download and Convert Data from Instrument to File (Step
    4 + 5)
7.  Download Electronic Chart Recorder Data from Instrument
    to File
8.  View Data File Data

9.  Exit Program

=====
Please enter option (1 to 9):
=====
```

**IDL program commands on the computer keyboard:**

To select an item, press a number.

To get out of any item, press <ESC>.

To abort downloading or conversion of data, press <ESC> five times in sequence.

Press <ENT> to initiate an activity after entering a file name.

**Definitions:**

1. Modify Serial Port Setup. Some computers have more than one serial port. The default position is port number 1. If, however, you are already using port number 1 for a mouse or other serial device, then change to port number 2 by pressing <1> on your computer, then pressing <2> to select port number 2.

If the wrong port is selected, during downloading "COMMUNICATION ERROR" will appear on the fluorometer screen. Abort the downloading procedure, select the correct port, and initiate the downloading sequence again.

2. Go to DOS. By pressing <2> on your computer keyboard, you can go to DOS and enter DOS commands. This is a convenient feature if, for example, you want to check the directory or erase files to free additional memory.
3. List directory. If you press <3> on your computer keyboard, you will be prompted to enter the name of a directory for viewing the files in that directory. For example, if you enter C:\dirname, a list of the files in the directory called "dirname" on the C drive will appear. Press <ENT> to see a list of the files in the current directory. You can also use a wildcard to list only the "PRN" or "PLT" files: i.e., \*.PRN will list only the files with a PRN extension. After a directory has been listed, press <ESC> to return to the IDL program.
4. Download Data from Instrument to File. Pressing <4> on the keyboard accesses the downloading sequence. In this step, data is transferred from the fluorometer to the computer. It is saved in a binary (BIN) compressed data file, which is not in a readable or printable form until it is converted into ASCII format (menu item 5). The reason for the BIN file is to save disk space and downloading time.

During step 4, after the data is downloaded from the fluorometer, IDL will prompt you for a file name: a maximum of eight-characters and a period, followed by the extension "BIN." You do not have to type the period or BIN; it will be entered automatically, unless you enter a different extension. It is strongly recommended that you use the "BIN" extension to distinguish these files from readable ASCII files. If you like, you can take the default name "IDATALOG.BIN" by pressing <ENT>.

The data will automatically be saved on the drive where the program is located and opened, unless you enter a different drive path. For example, if you opened IDL from a floppy in drive A, and you wish to save data to the



hard drive C, then when prompted to name the file, type "C:\name of directory\xxxxxxx (the file name)" and press <ENT>. The file will then be saved on drive C in the directory named.

If the fluorometer memory is full, the minimum disk space required for downloading alone (separate from the program itself) is 130 KBytes, independent of data logging parameters chosen.

When downloading is in process, "Serial Communication Error" will appear on the computer screen after several seconds if:

- The power to the fluorometer fails;
- The RS-232 cable is disconnected;
- <ESC> is pressed on the fluorometer keypad (aborts the downloading sequence).

When downloading is in process, "COMMUNICATION ERROR" will appear on the fluorometer display if:

- The wrong serial port is selected (item 1);
- The RS-232 cable is disconnected;
- <ESC> is pressed 5 times in sequence on the computer (aborts the downloading sequence).

If downloading is interrupted for any reason, simply return to the Main Menu on the computer and screen 5.4 on the fluorometer and rerun the downloading sequence.

If speed is important to you, you are advised to use at least a 286 or higher model computer. For example, if the fluorometer's internal data logger memory is full, it may take as long as 9 minutes for data to be downloaded using an XT-type computer.

The fluorometer will display the number of data blocks downloaded. Each data block is 1 KByte, with a maximum of 127 blocks possible.

5. Convert Downloaded Data File to Ascii File. This step takes the BIN file downloaded from the fluorometer and converts it to an ASCII file, which can be retrieved, read, and manipulated using a spreadsheet program or a word processing program.

Pressing <5> accesses the ASCII conversion sequence. You will be prompted to enter the downloaded (BIN) data file to be converted. Then you will be asked to give a name to the ASCII file: an eight-character name and a period, followed by the suffix (extension) "PRN." You do not have to

type the period or PRN; it will be entered automatically, unless you enter a different extension. It is strongly recommended that you use the "PRN" extension, as it is recognized by DOS as a printable file. If you like, you can take the default name by pressing <ENT>. Note that if you have just downloaded a file, the default name will be the same as the name for the BIN file including the drive path, except it will have a "PRN" extension.

If you wish to save the converted file on a different drive, then enter a different drive path. For example, if you are using a floppy in drive A, and you wish to save data to the hard drive C, then when prompted to name the file, type "C:\name of directory\xxxxxxx (the file name)" and press <ENT>. The file will then be saved with a PRN extension on drive C in the directory named.

When naming is complete, IDL will automatically begin converting the BIN file to an ASCII file. The percentage of data converted will appear in the lower right-hand corner of the computer screen. If conversion is interrupted, simply begin the conversion sequence again.

If speed is important to you, you are advised to use at least a 286 or higher model computer. For example, if the fluorometer internal data logger memory was full, it may take as long as 12 minutes for conversion to an ASCII file with an XT-type computer.

A great deal of disk memory will be required to save a full memory: for 18,000 points, over 900 KBytes may be required.

6. Download and Convert Data from Instrument to File. This step allows downloading and conversion to take place as a single step. The memory considerations and time factors for steps 4 and 5 above apply to step 6.

To download and convert as one step, press <6> on the computer. Then access screen 5.4 on the fluorometer and press <8> five times to start downloading. When it is completed, the IDL will prompt you to name the "BIN" file. "Data Retrieval Completed" will appear, and IDL will ask you to give a name to the new ASCII file. Type the name and press <ENT>, or press <ENT> to take the default, and IDL will convert the data to an ASCII file.

7. Download Electronic Chart Recorder Data from Instrument to File. If your fluorometer is equipped with the optional Electronic Chart Recording (ECR), menu item <7> allows you to download a page of the data (240 data points) from the internal data logger.

To download a page of data, access the ECR screen by pressing <\*> from screen 5.1. Page through the data until the page of data you wish to download is displayed. Then press <7> on your computer and <9> on the fluorometer. When downloading is completed, the IDL will prompt you to name the file. Type the name and press <ENT>, or press <ENT> to take the default ("ECR.PLT"), and IDL will save the data (with a "PLT" extension) in ASCII format. The "PLT" extension will help distinguish files downloaded from the ECR from other PRN files. When saving is complete, IDL will display "Data Retrieval Completed."

The information sent to the computer includes: data about internal data logging parameters (from screen 5.1), date, time, sample readout, and temperature. The data points will also be graphed with a line of asterisks (one for each data point) in a rectangular grid.

Once <9> is pressed, for the first 20 seconds none of the functions on the ECR screen will operate until the data is downloaded from the fluorometer. Then, depending upon the speed of your computer, it may take as long as a minute for the computer to process the data. To abort the downloading procedure, press <ESC> on the fluorometer or computer.

Once a file is downloaded from the ECR, it can be printed, viewed, or imported into a word processing or spreadsheet program for manipulation. See Appendix 11G.

8. View Data File Data. This item allows a "PRN" or "PLT" file, or any text file (ASCII file with a maximum of 80 characters per line), to be accessed and viewed a page at a time. Press <8> and IDL will prompt you for the name of the file to be viewed. Enter the name, including any drive path specification, a period and the extension "PRN" or "PLT" (or other extension if applicable). The file will appear on the screen. To move through the data a line at a time, press <L>. Press any key to page down through the data. When the end of the file is reached, IDL will display "Press <ESC> to return to IDL program." To return to IDL before completely viewing a file, press <Q>.

If you can't remember the name of a file you want to view, check by accessing the "List Directory" function, item 3 on the Main Menu, before entering the view data file function.

**Running IDL:**

This procedure is for downloading and converting in two steps (steps 4 and 5 of IDL). If you wish to use step 6, the combined method, the procedure is basically the same except in step 6 below, enter <6>; and you will do steps 8 - 10 below as a single step. If you wish to download a page of data points from the ECR to a separate file, refer to the section "Running IDL with ECR," immediately following these instructions.

1. Connect your computer to the fluorometer's RS-232 serial port (a DB9 female connector on the power/telemetry connector).
2. Load the IDL program by typing "IDL\_1B" (for Version 1B) at the DOS prompt (C:\ or A:\, etc.). The Main Menu will appear.
3. Access screen 5.0 on the fluorometer. From the Main Menu, press <5>.
4. If data is currently being logged, press <3> to access screen 5.3 and set the logging status to "Stop."
5. From screen 5.0, press <4> to bring up screen 5.4.
6. On the computer keyboard, press <4> to access the downloading procedure.
7. On the fluorometer keypad, press <8> five times and data will be downloaded. The fluorometer will display the number of blocks of data downloaded. Depending on the speed of your computer, it will require from 2 to 9 minutes for downloading if the fluorometer memory is full.
8. When downloading is finished, IDL will ask you to name the downloaded file. Type in a maximum of eight characters for the name. (If you wish to change the drive path, enter the drive, followed by the name of the file, i.e.: "C:\name of directory on C drive\name of file".) The name will appear with the "BIN" extension, unless you enter a different one. It is strongly recommended that you use the "BIN" suffix for all downloaded files to distinguish them from the readable ASCII files (step 5 on the IDL Main Menu). Press <ENT> on the computer keyboard to take the name chosen or the default name "IDATALOG.BIN." The computer will display "Data Retrieval Completed".

If you would like to wait until later to convert the data to ASCII format in order to save disk space, then skip to step 11.

To convert the data to ASCII, proceed with step 9.

9. To convert a BIN file to an ASCII file, press <5> on the computer keyboard. IDL will then ask you to name the file to be converted to an ASCII file (the name of the BIN file you last downloaded or the default name will appear). Press <ENT> to take the default, or type in the name of the BIN file you wish to convert (including any drive path specified) and press <ENT>.
10. IDL will then ask you to name the new ASCII file. Type in a maximum of eight letters. (If you wish to change the drive path, enter the drive, followed by the name of the file, i.e.: "C:\name of directory on C drive\name of file".) The name will appear with the "PRN" extension, unless you enter a different one. It is very important to use the "PRN" suffix because it is commonly used in DOS-based programs to identify a printable file. This extension will also help distinguish between the "BIN" files and the converted files. Press <ENT> on the computer keyboard to take the name chosen or the default.

If the BIN file is found and the computer is able to open the PRN file, the compressed data from the BIN file will be converted to an ASCII file. The percentage of data converted will appear in the lower right-hand corner of the computer screen.

11. When finished, press <9> to exit IDL.
12. Disconnect the computer from the fluorometer. Erase the data currently in the fluorometer and enter new internal data logging parameters if desired, or resume logging with the previous parameters (see Appendix 11E). Return the fluorometer to normal operation.

**Running IDL with ECR:**

1. Follow steps 1 - 4 in the previous section, "Running IDL."
2. From screen 5.0, press <1> to bring up screen 5.1, then press <\*> to call up the electronic data chart.
3. Page through the data until the page of data you want to download is displayed.
4. On the computer keyboard, press <7> to access the downloading procedure.
5. On the fluorometer keypad press <9>. It may require a minute or so to process the data, depending upon the speed of your computer. You will not

be able to access ECR functions on the keypad during the first 20 seconds. Press <ESC> on the fluorometer or computer to abort the downloading.

6. When downloading is finished, IDL will ask you to name the downloaded file. Type in a maximum of eight characters for the name. (If you wish to change the drive path, enter the drive, followed by the name of the file, i.e.: "C:\name of directory on C drive\name of file".) The name will appear with the "PLT" extension, unless you enter a different one. It is strongly recommended that you use the "PLT" extension, as this will distinguish ECR files from other IDL "PRN" files. Press <ENT> on the computer keyboard to take the name chosen or the default name (ECR.PLT). The computer will display "Data Retrieval Completed".
7. Download another page of data, if desired; or, press <9> to exit IDL.
8. Disconnect the computer from the fluorometer. Erase the data currently in the fluorometer and enter new internal data logging parameters if desired, or resume logging with the previous parameters (see Appendix 11E). Return the fluorometer to normal operation.

**F. Examining the Downloaded Data (from either external or internal serial data logging)**

The ASCII-format "PRN" or "PLT" files can be opened, viewed, or printed using typical DOS commands.

For your convenience, we have provided you with a "browse" program, which will allow you to examine any ASCII file using various cursor keys. (See "Viewing a file with the Browse Command," below.)

If you have been logging data for some time, you will have a lot of data to examine and it is suggested that you consider editing your file (see Editing a File, below) before you do anything else.

**NOTE:** If speed is important to you, it is recommended that you use a 286 or higher model computer. An XT-type will work, but it will be very slow.

A typical line of data from the internal data logger will look like this:

```
00001: 10/24/91 14:10:28 = 11.300 98.6 (F)
```

The first column is an index number; the second is the date; the third, the time; the fourth, the sample readout (as reflected on the HOME screen); and the final column indicates the sample temperature, available only if your fluorometer is equipped with temperature compensation and you choose to log temperature.

Opening a File. To open the file, at the DOS prompt enter TYPE and the file name, i.e.: "TYPE xxxxxxxx.PRN. This command, however, will open the file and the computer will rapidly scroll through the data.

Viewing a File with the Browse Command. The "browse" command allows you to view any ASCII file at your own pace using the cursor arrows, Page Up, Page Down, Home, and End commands. To view a file in this way, type BROWSE and the file name, i.e., "BROWSE xxxxxxxx.PRN".

Printing a File. To print a file, at the DOS prompt, type PRINT and the file name, i.e.: "PRINT xxxxxxxx.PLT". This will print the entire file; keep in mind that if you have been logging data for some time, this might be several hundred pages.

Viewing a File. To view a file a page at a time, at the DOS prompt type MORE < and the file name, i.e.: "MORE < xxxxxxxx.PRN". You can then use any key to page down through the data. Again, if you have been logging data for some time, you may have several hundred pages of data to scroll through. To escape from viewing, press <Ctrl C> or <Ctrl Break>.

Note that you can also view a file using the IDL program (menu item 8).

Editing a File. To edit a file, the data can be imported into a word processing program or a spreadsheet program.

Note that if you have Internal Data Logging and the optional Electronic Chart Recording, you can download a page of data (240 data points) to a separate file. This is a very manageable file size for manipulation of data.

**Using Word Perfect®.** If the fluorometer's internal data logger memory was full, you probably have a PRN file exceeding 900 KBytes. This file can be opened as a word processing file.

For example, using Word Perfect, the entire file can be opened, examined, and edited to a more manageable size. With a full memory, a file will cover some 18,500 - 64,800 lines and several hundred pages.

Open the file as a DOS text file (without conversion); this will allow for editing and will be much faster than converting a text file to Word Perfect. For example, with an XT-type computer, it may take 5 minutes to load the whole file as a text file; to convert the file to a Word Perfect file, it might take more than 30 minutes.

To open it as a DOS text file, open a new Word Perfect file, press <Ctrl F5> to access the "Text In/Out" function, then press item <1> DOS; then <3>

Retrieve (CR/LF to [SRT] in HZone" to retrieve the document in DOS text. You can then edit the file to contain only the data of interest to you: select various pages; eliminate repetitive data, etc. Or, you could print the entire file or selected pages.

If you intend to import the data into a spreadsheet program, it is recommended that you edit the file to 8000 lines or less. Lotus 123©, for example, will accept only the first 8,192 lines of a PRN file.

To import to a spreadsheet program, you must save the word processing file as a DOS text file.

**Using Lotus 123©.** If the fluorometer's internal data logger memory was full, only the first 8,192 lines of the PRN file can be imported into Lotus. A slow computer (4.77 MHz XT without a math processor) can take more than an hour to convert the first 8,192 lines of data, and about 853 KBytes of memory will be required.

Thus, when dealing with a large file, it is recommended that you edit the file first using a word processing program. Open/save the edited word processing file as a DOS text file and then import it into Lotus. (Lotus commands: Worksheet; File; Import; Numbers; name of file to be imported (including the "PLT" extension, if applicable.)

**Using Microsoft Excel®.** Data "PRN" files can be imported into Excel® (version 4.0 or greater) running on Windows©. You can use the "column delimiter" function to organize the data in the proper columns. To use the column delimiter function:

1. Start Windows running.
2. Open Excel program.
3. Under "File", select "Open".
4. Dialog box appears. Select the drive your "PRN" file is on. Under "List files of type", select \*.\* , i.e., all types. Your PRN file should appear.
5. While still in the dialog box, open the "Text..." dialog box. Under "column delimiter", select "Space".
6. Select and open your PRN file and it will feed into the proper columns.



G. Power/Telemetry Connector Pin Inputs and Outputs

**Power/Telemetry Connector**  
(Male pins, receptacle mounted on instrument, front view)

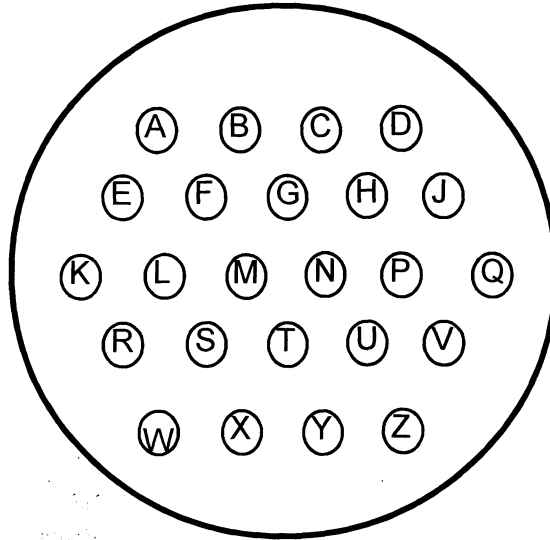

**RS-232 Serial Connector**  
(DB9 female, front view)

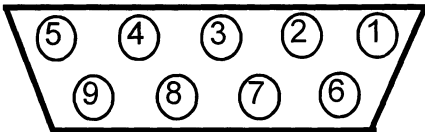

RS-232 Serial Output	
PIN	CONNECTION
W	6+8 (data set ready)
X	2 (transmit)
Y	3 (receive)
Z	5 (signal ground)

Power Input	
PIN	CONNECTION
K	Negative (12 VDC)
L	Positive (12 VDC)
N	Green (chassis ground)

Analog Output (DC volts)	
PIN	CONNECTION
U	Black (negative)
V	Red (positive)

*Page intentionally blank.*

## GLOSSARY

<u>Term</u>	<u>Definition</u>
Auto-ranging	The Model 10-AU can be set to choose the optimum range for the sample being read. This "auto-ranging" function allows both low and high concentrations to be read with the optimum resolution. See Section 2G, subsection 2 and screen 2.43.
Chopper Motor Speed	In the diagnostic mode, chopper motor speed refers to the speed of the chopper motor which is used in the light path to stabilize the fluorometer. A motor speed problem can typically be repaired only by returning the instrument to the factory. See Section 4 and Appendix 5B.
Circuit Failure	In the diagnostic mode, a circuit failure alarm refers to a breakdown on one of the printed circuit boards located in the fluorometer. This failure can typically only be cured by returning the instrument to the manufacturer. See Section 4.
Continuous-flow Cuvette/Cell	A glass or quartz tube, housed in a Delrin body, through which sample flows for reading on a continuous basis. (Appendix 7.)
Cuvette	The glass or quartz test tube which holds the sample through which the light from the lamp shines. The cuvette is held by the proper size cuvette holder. See Appendix 7.
Emission Filter	A filter located between the cuvette and the photomultiplier window. It may be encased in the emission filter holder. Its function is to pass only wavelengths of light particular to your measurements to the light detector. See Appendices 2 and 8.

## **Model 10-AU-005-CE Fluorometer User's Manual**

<b><u>Term</u></b>	<b><u>Definition</u></b>
Excitation Filter	A filter(s) particular to your application located between the lamp and the flow cell or cuvette. Its function is to transmit wavelengths of light particular to your application. See Appendices 2 and 8.
Fluorometer Malfunction Alarm	An alarm activated when the system senses a malfunction within the fluorometer. See Section 4.
Span	A function used to fine tune the sensitivity during calibration. Using the keypad, the operator increases or decreases Span on screens 2.11 and 2.3 when calibrating the instrument. See Section 2G.
High Voltage	In the diagnostic mode, this refers to the voltage to the photomultiplier tube. The high voltage controls the sensitivity of the photomultiplier tube. A high voltage failure can typically only be repaired by returning the instrument to the manufacturer. See Section 4 and Appendix 5B.
High Level Alarm	An alarm activated when the sample reads above the user-set level for triggering this alarm. See Section 4 and Appendix 5A.
Lamp	A six-inch fluorescent tube-type lamp, which is housed in the front of the fluorometer and excites the sample with light passed through the excitation filter. This lamp should not be viewed directly as it will cause a sunburn condition to your eyes. A lamp failure can usually be cured by replacing the lamp. See Section 4 and Appendix 8.
LCD	This is the liquid crystal display, the digital display mode used on the fluorometer. See Section 2B.

<b><u>Term</u></b>	<b><u>Definition</u></b>
Range (Concentration Range)	The operator sets the concentration range in increments of 10 (Low, Med, High) during calibration on screen 2.42. See Section 2G. (See also Auto-ranging, above.)
Sensitivity Adjustment Knob	A control located at the lower right side of the keypad that sets the overall operating level (sensitivity) of the fluorometer. It is locked with a hex nut located to the left of the keypad. Before calibrating your instrument for the first time, you must set the operating level for your application using this knob (see Appendix 6B). Thereafter, <b>DO NOT ADJUST</b> the Sensitivity Adjustment Knob, unless you change to a different kind of lamp or filters, or a new cuvette size.
Temperature Probe	If you have purchased the optional temperature-compensation package, your Model 10-AU will have a temperature probe. This is a sensor that detects the temperature of the sample in the flow cell (it will not operate with the cuvette holder) for use in temperature correction. For more information on temperature parameters, see Appendix 5A, screen 1.7.

**THIS PAGE INTENTIONALLY BLANK**

# INDEX

## A

---

- accessories, A4
  - batteries, A4-1
  - computers, recorders, data loggers, A4-4
  - dye injection pumps, A4-3
  - hoses, A4-3
  - pumps, A4-1 to A4-3
- alarms, 4-1 to 4-6
  - basics, 4-2 to 4-3
  - circuit failure, 4-4
  - clearing, 4-2
  - delay and range, 4-1
  - fluorometer too cold, 4-4
  - fluorometer too hot, 4-4
  - high level, 4-5; A5-4
  - high voltage too high, 4-5
  - high voltage too low, 4-5
  - internal function, 4-1
  - lamp, 4-4
  - low level, 4-5; A5-4
  - low power, 4-5
  - multiple, 4-3
  - system alarms, 4-2
- altitude, 1-5; A1-2
- Analog (voltage) output, A11-1
- attenuator plate, A6-5
  - installing, A8-3
  - selection guide, A8
- auto-ranging, 3-3

## B

---

- bar graph (Screen 1.3), A5-5
  - display, A5-5
  - full scale, A5-5
  - HOME screen, 2-6
  - scale control, A5-5
  - zero point, A5-5
- batteries, A4-1
  - marine battery cable, A1-1
- Beeper, A5-6
- Blank, 3-5
  - blank value, 3-2
  - calibration (Run blank), 3-5; 3-15
  - default/range (table), 3-4
  - high blank, 3-9
  - Run blank (screen 2.11), 3-5
  - subtract blank, 3-5

- blank screen, 4-6
- BLK>FS, 3-7; 3-16

## C

---

- calibration, 3-1 to 3-17
  - >9999, 3-7; 3-17
  - averaging readings, A6-4
  - basics, 3-1
  - BLK>FS, 3-7; 3-16; 3-19
  - broad range of concentrations, 3-11
  - bubbles in sample, A6-4
  - Calibration Screen 2.0, 3-2
  - changing applications, A6-3
  - considerations, A6-1 to A6-5
  - continuous-flow, A6-3
  - cuvettes, A6-4
  - default/range (table), 3-4
  - direct concentration, 3-9
  - Full scale value table, 3-7
  - high blank, 3-9
  - high concentrations, 3-11
  - linearity, A6-2
  - low concentrations, 3-11
  - methods, 3-10 to 3-13
  - OVER, 3-7; 3-16; 3-17
  - preliminaries, 3-9
  - quenching, A6-2
  - range (choosing), 3-11 to 3-13
  - raw data readout, 3-10
  - standard concentration, 3-11 to 3-13
  - storage of samples, A6-4
  - temperature coefficient, A6-1
  - temperature compensation, A6-1
  - temperature (cuvette holder), A6-2
- Calibration Screen 2.0, 3-2
  - auto-ranging, 3-3
  - blank val., 3-2
  - blanking, 3-5
  - cal std val., 3-2
  - Calibration Screen 2.0 Defaults, 3-4
  - full scale (FS), 3-7
  - ranges, 3-2
  - reset calibration defaults, 3-2
  - Run standard solution, 3-5 to 3-8
  - Span, 3-5; 3-7
  - standard soln conc, 3-2
  - time constant (TC), 3-5; 3-7
- Cal std val, 3-2; A5-10; A5-12
  - default/range (table), 3-4
- chart recorder (electronic; ECR), A11-12
- chlorophyll, A3-1
  - calibration standard, 3-13
  - linearity, A10-2
  - operating level, A6-11
  - temperature coefficient, A6-1
- clock, 2-8
- computers, A4-4; A11; see data collection
  - Macintosh, see Macintosh
- condensation, A7-3
- continuous-flow, see flow cell controls, 2-2
  - location (figure), 2-2
- cuvette, 1-5; see also flow cell
  - calibrating with, A6-3
  - condensation, A7-1
  - installing, A7-7
  - installing 13 mm, A7-7
  - installing 13 & 25 mm, A7-7
  - installing 25 mm, A7-7
  - leaks/spills, A7-10
  - linearity, A6-2
  - maintenance, A7-1
  - removing, A7-5
  - sensitivity, A6-4
  - temperature, A6-1

## D

---

- data collection, A11
  - data collection software, A11-6
  - defaults/range external (table), A11-4
  - examining data, A11-24
  - internal data logging, A11-10
  - Macintosh, A11-7

output (voltage), A11-1  
programming information, A11-4  
serial data output, A11-2  
serial data protocol, A11-4  
software, spreadsheet interface, A11-6  
DOS-based, A11-6  
Windows™, A11-6  
Windows (Excel®), A11-26  
data loggers, A4-4; A11  
desiccant, A7-3  
detection limits, A10  
chlorophyll, A10-2  
oil measurements, A10-1  
tracers (dye), A10-2  
diagnostic information, A5-8 to A5-12  
Blank, A5-10  
Cal std val, A5-10  
chopper RPM, A5-9  
circuit (ckt) status, A5-9  
fluorescence readout, A5-10  
Full scale (FS), A5-10  
high voltage, A5-9  
lamp, A5-9  
operation hour, A5-9  
operation since, A5-9  
PM signal output, A5-10  
power level, A5-9  
Span level, A5-10  
temp. comp. readout, A5-10; A5-12  
temperature (instr), A5-9  
direct concentration readout, 3-9  
Discrete sample averaging, A5-6  
discrete samples, see cuvette  
digital display, 2-2  
bar graph, A5-5  
contrast, 2-3  
HOME screen options, 2-8  
location (figure), 2-2  
screens flow chart, 2-8  
temperature, A5-7  
digits, 2-8  
>9999, 3-7; 3-17  
HOME screen (>999), 2-7; 3-18; 3-19  
Run standard, 3-7  
screen 3.2 (>9999), A5-11

display, see digital display  
doors, see ranges  
drifting readings, 4-6  
dye studies, A3-2

## **E**

---

electronic chart recording (ECR), A11-12  
emission filter, A8-1  
removing, A8-2  
replacing, A8-3  
selection guide, A9  
excitation filter, A8-1  
removing, A8-2  
replacing, A8-3  
selection guide, A9

## **F**

---

features, see operational parameters  
filters (optical), A8  
lamp, A8-1  
locations (figure), A8-7  
replacing, A8-2 to A8-5  
selection, A9-1  
selection guide, follows A9-2  
theory, A9-1 to A9-2  
types, A8-1  
flow cell, 1-5  
calibrating with, A6-3  
condensation, A7-3  
desiccant, A7-3  
external connections, A7-3  
flow rate, A4-1  
installing, A7-7  
installing 1-piece, A7-8  
installing 3-piece, A7-8  
leaks, A7-2; A7-10  
linearity, A6-2  
maintenance, A7-2  
removing, A7-5  
removing 1-piece, A7-5  
removing multi-part, A7-5  
sensitivity, A6-4  
temperature compensation, A6-1  
flow measurements, A3-2  
flow rate, A4-1  
fluorescence (principles), A2  
figure, A2-4

full scale (FS), 3-7  
calibration, 3-16  
Run standard, 3-7  
value table, 2-8; 3-7

## **G**

---

Glossary, G1 to G3  
grab samples, see cuvette  
graph, see bar graph

## **H**

---

helium, 1-5  
HOME screen, 2-8  
>999, 3-18  
bar graph, see bar graph  
digits, 2-8; 3-7; 3-18  
direct concentration, 3-9  
display, A5-4  
negative (minus), 3-19  
OVER, 3-18  
raw data, 3-20  
hoses, A4-3

## **I**

---

identification (ID) code, A5-7  
internal data logger, A11-10 to A11-24  
configuration, A11-13  
defaults/ranges (table), A11-16  
download data (definition), A11-15  
download data (IDL program), A11-18  
electronic chart recording (ECR), A11-12  
erase data, A11-15  
examining data, A11-24  
overview, A11-10  
screen 5.0, A11-11  
software (IDL), A11-17  
software (running IDL), A11-22  
starting (status), A11-14  
strategy, A11-14  
temperature, A11-14  
view data, A11-21



**J, K**

- keypad, 2-2
  - functions (flow chart), 2-8
  - security ID, 2-2
  - Span adjust at calibration, 3-1; 3-16; 3-17

**L**

- lamp, A9
  - alarm, 4-1; 4-4
  - changing, A8-5
  - location (figure), A8-7
  - selection guide, following A9-2
  - theory, A2; A9-1
- LCD, see digital display
- leaks, A7-10
  - flow cell, A7-2
- linearity, A6-2

**M**

- Macintosh computer, A11-7
  - discrete samples, A11-8
  - Microphone® program, A11-7
  - serial data logging, A11-8
- Main Menu, 2-3; 2-6
- maintenance, 5-1
  - continuous flow, A7-2
  - cuvette holder, A7-1
  - desiccant, A7-3
  - water in sample compartment, A7-10
- minus/negative (-) readings, 3-19
- moisture, A7-2; A7-3; A7-10
- mounting, A1-2

**N**

- negative/minus (-) readings, 3-19; A5-11
- no response, 4-6
- NVRAM, 4-6

**O**

- oil measurements, A3-2
- operating level (setting), A6-6 to A6-13
  - chlorophyll (extractive), A6-11
  - chlorophyll (in vivo) A6-11
  - chlorophyll (low levels), A6-12
  - general method, A6-7 to A6-9
  - Rhodamine WT, A6-10
- operating information, 2-1
  - activation, 2-5
  - blanking, 3-5
  - calibration preliminaries, 3-9
  - Calibration Screen 2.0, 3-2
  - Calibration Screen 2.0 Defaults, 3-4
  - clock, 2-7
  - controls, 2-2
  - external data logging, A11-1 to A11-9
  - full scale (FS), 3-7
  - HOME screen, 2-8
  - Internal Data Logger, A11-10 to A11-24
  - operational parameters, A5-1 to A5-8
  - ranges, 3-2
  - reset calibration defaults, 3-2
  - Run blank, 3-5
  - Run standard solution, 3-6 to 3-7
  - screens, 2-3 to 2-4
  - screens flow chart, 2-8
  - sensitivity adjustment, 3-1
  - standard soln conc, 3-2
  - time constant (TC), 3-2
- operation, see reading samples
- operational parameters, A5-1 to A5-8
  - alarm, A5-4
  - backlight off time, A5-6
  - bar graph, A5-5
  - beeper status, A5-6
  - discrete sample averaging, A5-6
  - HOME display, A5-4

- output (analog), A11-1
- security ID, A5-7
- serial output, A11-2
- temperature, A5-7

- OVER, 3-7
  - calibration, 3-16 to 3-17
  - routine operation, 3-18

**P**

- precautions, 1-1
- pollution, 1-5; A1-2
- power, A1-1
  - 115 or 230 VAC, A1-1
  - changing power source, A1-1
  - DC power, A1-1
  - ON/OFF, 2-2
  - power/telemetry pins (figure), A11-27
- power/telemetry connector, 2-2
  - pin inputs/outputs, A11-27
- power (pwr) level, A5-9
- principles of fluorescence, A2
  - figure, A2-4
- process control, A3-2
- pumps, A4-1
- pumps (dye injection), A4-3

**Q**

- quenching, A6-2

**R**

- ranges, 3-2
  - auto-ranging, 3-3
  - calibration (choosing), 3-11 to 3-13
  - FS default/range (table), 3-3
  - Range/standard concentration (figure), 3-12
  - Range/standard concentration (table), 3-13
  - sensitivity adjustment, 3-1
- raw data readout, 3-10; 3-20
- reading samples, 3-18 to 3-20
  - >999, 3-19
  - auto-ranging, 3-18
  - data logging, A11

## Model 10-AU-005-CE Fluorometer User's Manual

direct concentration, 3-9  
discrete sample averaging,  
3-19  
HOME screen, 3-18  
manual range, 3-18  
minus/negative (-), 3-19  
OVER, 3-18  
ratio method, 3-20  
raw data, 3-10; 3-20  
screen 3.2, A5-11  
sensitivity setting retrieval,  
3-20  
recorders, A4-4  
Rhodamine WT  
detection limits, A10-2  
linearity, A10-2  
operating level, A6-10  
temperature coefficient,  
A6-1  
Run blank, 3-5  
Run standard, 3-7

## S

---

safety, 1-1  
sample system, A7  
condensation, A7-3  
continuous-flow mainten-  
ance, A7-2  
cuvette holder mainten-  
ance, A7-1  
desiccant, A7-3  
external connections, A7-3  
installation, A7-7 to A7-9  
removing, A7-5 to A7-6  
sample compartment  
(figure), A8-7  
water in sample compart-  
ment, A7-10  
Screen 2.0 (Calibration), 3-2  
Screen 2.11 (Run blank), 3-5  
Screen 2.3 (Run Standard),  
3-7  
Screen 3.1 (Diagnostic), A5-9  
Screen 3.2 (Diagnostic),  
A5-10  
screens, 2-3  
alarm, 2-4  
help, 2-4  
warning, 2-4  
moving through, 2-4  
screens flow chart, 2-8  
security ID, A5-7  
sensitivity, 3-1  
chlorophyll (extractive),  
A6-11  
chlorophyll (in vivo) A6-11  
chlorophyll limits, A10-2  
decreasing, A6-5  
fluorescent tracer limits,  
A10-2  
increasing, A6-4  
oil limits, A10-1  
operating level, A6-6 to  
A6-13  
ranges, 3-2  
retrieval, A6-13  
Rhodamine WT, A6-10  
Sensitivity Adjustment  
Knob, 3-1; A6-6  
Span, 3-5; 3-7  
Sensitivity Adjustment Knob,  
2-2  
location (figure), 2-2  
ranges/Span and, 3-1  
set operating level, A6-6  
serial data output, A11-2  
service, 5-2  
setup, 1-5  
filters, 1-5  
getting started, 1-3  
lamp, 1-5  
mounting, 1-5  
movement, 1-5  
power, 1-4  
sample system, 1-5  
temperature, 1-4  
water, 1-4  
Span, 3-5; 3-7  
default/range (table), 3-4  
Run blank, 3-5; 3-15  
Run standard, 3-7; 3-16  
view current level, A5-10  
specifications, A1-3 to A1-6  
spills, A7-10  
standard, 3-6  
cal std val, 3-2  
calibration (choosing),  
3-11 to 3-13  
concentration, 3-2  
default/range (table), 3-4  
linearity, A6-2  
Run standard (screen 2.3),  
3-7  
Run standard solution,  
3-16  
soln conc, 3-2  
standard concentration/

range (figure), 3-12  
standard concentration/  
range (table), 3-13  
unknown concentration,  
3-6

## T

---

temperature  
calibration considerations,  
A6-1  
coefficient, A6-1  
compensation, A5-8  
operating, A1-2  
storage, A1-2  
temperature compensation,  
A5-8  
time constant (TC), 3-2  
default/range (table), 3-4  
Run blank, 3-5  
Run standard, 3-7  
tracer studies, A3-2  
transient overvoltages, 1-5, A1-2  
troubleshooting, 4-4 to  
4-6  
blank/dark screen, 4-6  
circuit failure, 4-4  
fluorometer too cold, 4-4  
fluorometer too hot, 4-4  
high level, 4-5  
high voltage too high, 4-5  
high voltage too low, 4-5  
lamp, 4-4  
low level, 4-5  
low power, 4-5  
no response, 4-6  
noisy/erratic readings, 4-5  
unstable/drifted readings,  
4-6

## U, V, W, X, Y, Z

---

warranty, 5-1  
water and dirt, A1-2